

Keycaps, plastic, 14 mm

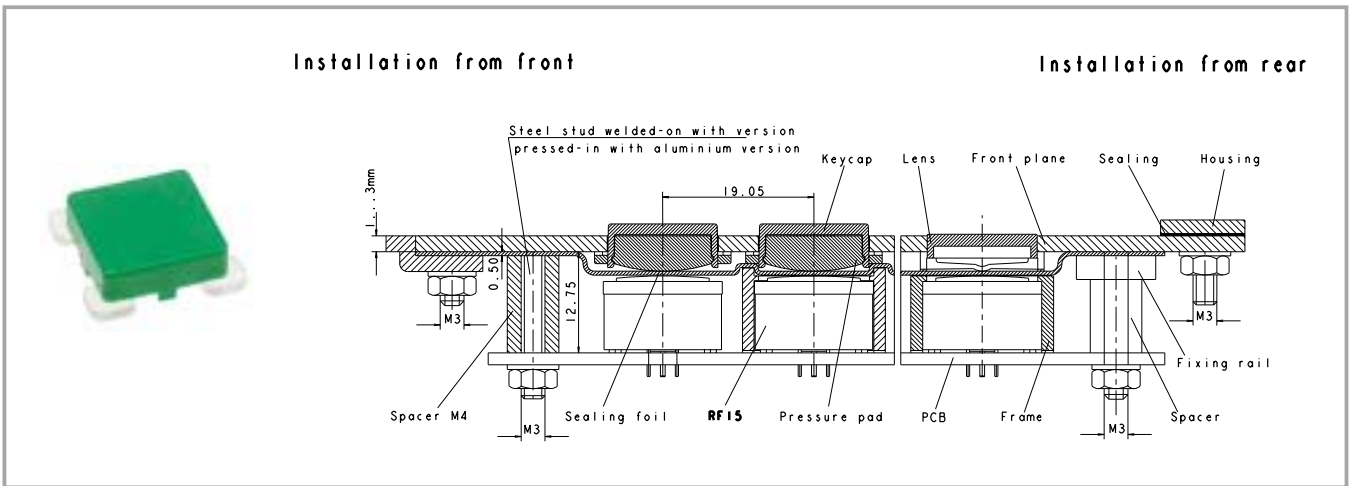

General data

Keycap system for 19.05 mm grid. The keycaps can be legended by laser-printing, engraving or standard printing. Legend inserts can be used for the transparent versions. Keycaps / sets with legends and other keycap shapes / colours available on request.

Keycaps, plastic, 1-module, opaque, with pressure pad

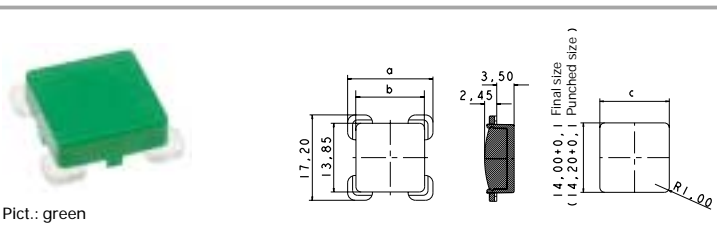

Size	Illuminability	Colour of lens	Dimension (a) keycap behind front panel	Dimension (b) keycap in front of front panel	Dimension (c) hole patterns final size	Order no. complete
1-module	no	opaque light grey	17.20 x 17.20 mm	13,85 x 13,85 mm	14.00 x 14.00 mm	5.04.668.001/0700
1-module	no	opaque red	17.20 x 17.20 mm	13,85 x 13,85 mm	14.00 x 14.00 mm	5.04.668.001/0309
1-module	no	opaque green	17.20 x 17.20 mm	13,85 x 13,85 mm	14.00 x 14.00 mm	5.04.668.001/0514
1-module	no	opaque yellow	17.20 x 17.20 mm	13,85 x 13,85 mm	14.00 x 14.00 mm	5.04.668.001/0409
1-module	no	opaque blue	17.20 x 17.20 mm	13,85 x 13,85 mm	14.00 x 14.00 mm	5.04.668.001/0611

Laser-printed on request, condition as supplied: Assembled.

4

RK 90

Keycaps, plastic, 1,5-module, opaque, with pressure pad

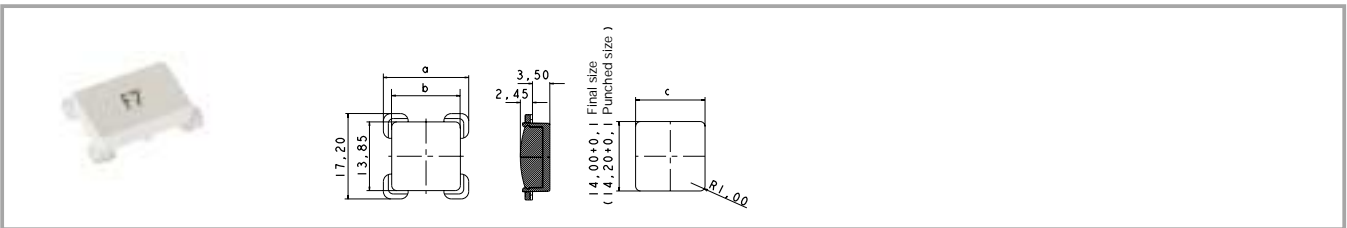

Size	Illuminability	Colour of lens	Dimension (a) keycap behind front panel	Dimension (b) keycap in front of front panel	Dimension (c) hole patterns final size	Order no. complete
1,5-module	no	opaque light grey	17.20 x 24.20 mm	13.85 x 20.85 mm	14.00 x 21.00 mm	5.04.668.003/0700
1,5-module	no	opaque red	17.20 x 24.20 mm	13.85 x 20.85 mm	14.00 x 21.00 mm	5.04.668.003/0309
1,5-module	no	opaque green	17.20 x 24.20 mm	13.85 x 20.85 mm	14.00 x 21.00 mm	5.04.668.003/0514
1,5-module	no	opaque yellow	17.20 x 24.20 mm	13.85 x 20.85 mm	14.00 x 21.00 mm	5.04.668.003/0409
1,5-module	no	opaque blue	17.20 x 24.20 mm	13.85 x 20.85 mm	14.00 x 21.00 mm	5.04.668.003/0611

Laser-printed on request, condition as supplied: Assembled.

Keycaps, plastic, 2-module, opaque, with pressure pad

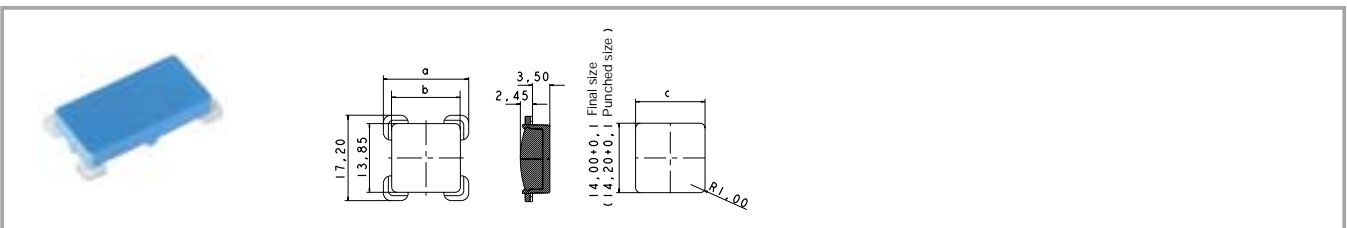

Size	Illuminability	Colour of lens	Dimension (a) keycap behind front panel	Dimension (b) keycap in front of front panel	Dimension (c) hole patterns final size	Order no. complete
2-module	no	opaque light grey	17.20 x 31.20 mm	13.85 x 27.85 mm	14.00 x 28.00 mm	5.04.668.004/0700
2-module	no	opaque red	17.20 x 31.20 mm	13.85 x 27.85 mm	14.00 x 28.00 mm	5.04.668.004/0309
2-module	no	opaque green	17.20 x 31.20 mm	13.85 x 27.85 mm	14.00 x 28.00 mm	5.04.668.004/0514
2-module	no	opaque yellow	17.20 x 31.20 mm	13.85 x 27.85 mm	14.00 x 28.00 mm	5.04.668.004/0409
2-module	no	opaque blue	17.20 x 31.20 mm	13.85 x 27.85 mm	14.00 x 28.00 mm	5.04.668.004/0611

Laser-printed on request, condition as supplied: Assembled.

4

RK 90

Keycaps, plastic, 1-module, transparent, with pressure pad

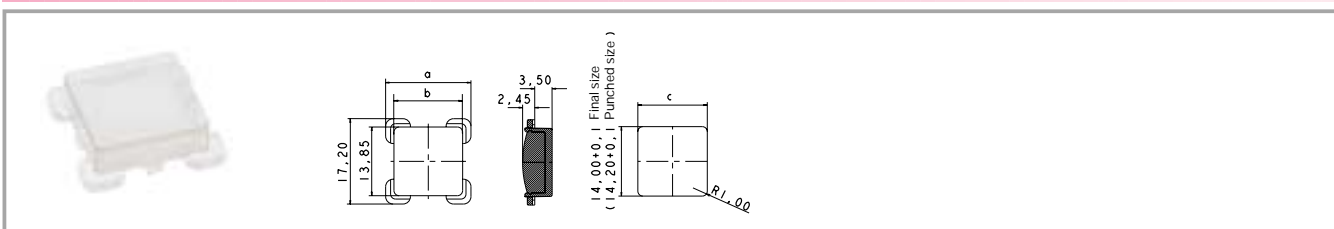

Size	Illuminability	Colour of lens	Dimension (a) keycap behind front panel	Dimension (b) keycap in front of front panel	Dimension (c) hole patterns final size	Order no. complete
1-module	yes	transparent colourless	17.20 x 17.20 mm	13.85 x 13.85 mm	14.00 x 14.00 mm	5.04.668.005/1002
1-module	yes	transparent red	17.20 x 17.20 mm	13.85 x 13.85 mm	14.00 x 14.00 mm	5.04.668.005/1307
1-module	yes	transparent green	17.20 x 17.20 mm	13.85 x 13.85 mm	14.00 x 14.00 mm	5.04.668.005/1510
1-module	yes	transparent yellow	17.20 x 17.20 mm	13.85 x 13.85 mm	14.00 x 14.00 mm	5.04.668.005/1403

Accessories:

Legend inserts for RK 90, 12 x 12, 1-module: 5.70.640.000/2000

Supplied as single parts, please order legend insert separately (legending on request).

Keycaps, plastic, 1,5-module, transparent, with pressure pad

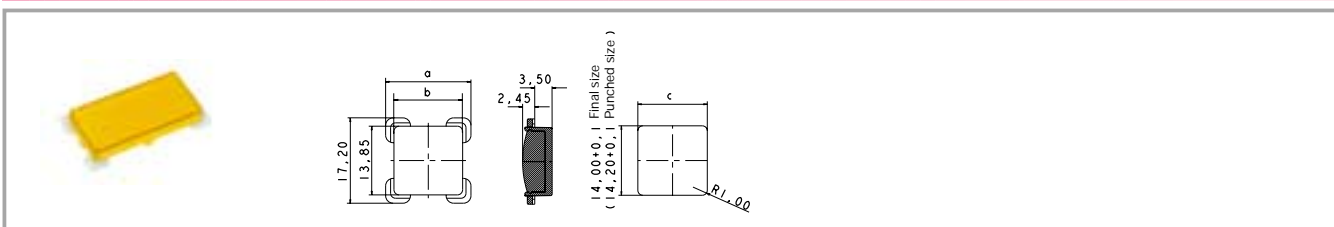

Size	Illuminability	Colour of lens	Dimension (a) keycap behind front panel	Dimension (b) keycap in front of front panel	Dimension (c) hole patterns final size	Order no. complete
1,5-module	yes	transparent colourless	17.20 x 24.20 mm	13.85 x 20.85 mm	14.00 x 21.00 mm	5.04.668.007/1002
1,5-module	yes	transparent red	17.20 x 24.20 mm	13.85 x 20.85 mm	14.00 x 21.00 mm	5.04.668.007/1307
1,5-module	yes	transparent green	17.20 x 24.20 mm	13.85 x 20.85 mm	14.00 x 21.00 mm	5.04.668.007/1510
1,5-module	yes	transparent yellow	17.20 x 24.20 mm	13.85 x 20.85 mm	14.00 x 21.00 mm	5.04.668.007/1403

Accessories:

Legend inserts for RK 90, 12 x 12, 1,5-module: 5.70.642.000/2000

Supplied as single parts, please order legend insert separately (legending on request).

4

RK 90

Keycaps, plastic, 2-module, transparent, with pressure pad

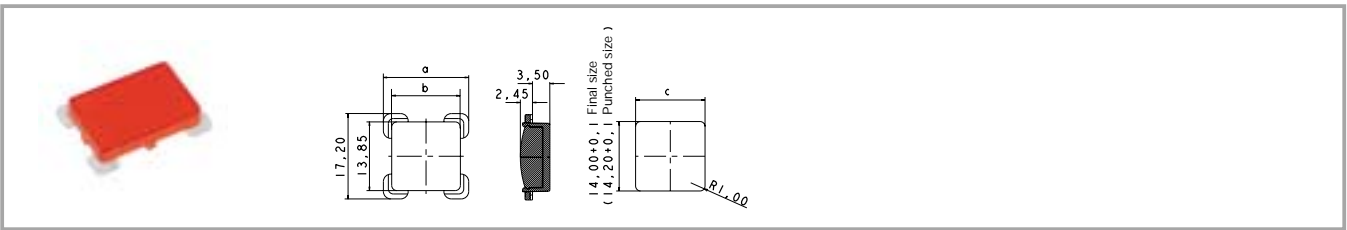

Size	Illuminability	Colour of lens	Dimension (a) keycap behind front panel	Dimension (b) keycap in front of front panel	Dimension (c) hole patterns final size	Order no. complete
2-module	yes	transparent colourless	17.20 x 31.20 mm	13.85 x 27.85 mm	14.00 x 28.00 mm	5.04.668.008/1002
2-module	yes	transparent red	17.20 x 31.20 mm	13.85 x 27.85 mm	14.00 x 28.00 mm	5.04.668.008/1307
2-module	yes	transparent green	17.20 x 31.20 mm	13.85 x 27.85 mm	14.00 x 28.00 mm	5.04.668.008/1510
2-module	yes	transparent yellow	17.20 x 31.20 mm	13.85 x 27.85 mm	14.00 x 28.00 mm	5.04.668.008/1403

Accessories:

Legend inserts for RK 90, 12 x 12, 2-module: 5.70.643.000/2000

Supplied as single parts, please order legend insert separately (legending on request). We recommend the fully illuminated RF 19 key/signal indicator for illumination.