



User Manual

**EASY412,
EASY600**

Control Relay

08/00 AWB2528-1304-GB

1st edition 1998, Edition date 04/98

2nd edition 1999, Edition date 06/99

3rd edition 1999, Edition date 11/99

4th edition 2000, Edition date 08/00

See list of revisions on page II

© Moeller GmbH, Bonn

Author: Dieter Bauerfeind

Editors: Thomas Kracht

Translator: Terence Osborn

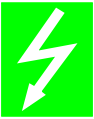

Warning!

Dangerous electrical voltage!

Before commencing the installation

- Disconnect the power supply of the device.
- Ensure that devices cannot be accidentally restarted.
- Verify isolation from the supply.
- Earth and short circuit.
- Cover or enclose neighbouring units that are live.
- Follow the engineering instructions (AWA) of the device concerned.
- Only suitably qualified personnel in accordance with EN 50 110-1/-2 (VDE 0105 Part 100) may work on this device/system.
- Before installation and before touching the device ensure that you are free of electrostatic charge.
- The functional earth (FE) must be connected to the protective earth (PE) or to the potential equalisation. The system installer is responsible for implementing this connection.
- Connecting cables and signal lines should be installed so that inductive or capacitive interference do not impair the automation functions.
- Install automation devices and related operating elements in such a way that they are well protected against unintentional operation.
- Suitable safety hardware and software measures should be implemented for the I/O interface so that a line or wire breakage on the signal side does not result in undefined states in the automation devices.
- Ensure a reliable electrical isolation of the low voltage for the 24 volt supply. Only use power supply units complying with IEC 60 364-4-41 (VDE 0100 Part 410) or HD 384.4.41 S2.
- Deviations of the mains voltage from the rated value must not exceed the tolerance limits given in the specifications, otherwise this may cause malfunction and dangerous operation.
- Emergency stop devices complying with IEC/EN 60 204-1 must be effective in all operating modes of the automation devices. Unlatching the emergency-stop devices must not cause restart.
- Devices that are designed for mounting in housings or control cabinets must only be operated and controlled after they have been installed with the housing closed. Desktop or portable units must only be operated and controlled in enclosed housings.
- Measures should be taken to ensure the proper restart of programs interrupted after a voltage dip or failure. This should not cause dangerous operating states even for a short time. If necessary, emergency-stop devices should be implemented.
- Wherever faults in the automation system may cause damage to persons or property, external measures must be implemented to ensure a safe operating state in the event of a fault or malfunction (for example, by means of separate limit switches, mechanical interlocks etc.).

**List of revisions to
AWB2528-1304-GB**

This manual has been completely revised due to the new “easy” types. The following table lists the most important modifications and additions in comparison to the last edition.

New types in 06/99	New types in 11/99	New types in 08/00
EASY412-DC-TC	EASY619-AC-RC(X)	EASY412-DA-RC
EASY412-AC-RC(X)	EASY621-DC-TC(X)	EASY618-DC-RC
EASY620-DC-TC	EASY618-AC-RE	EASY619-DC-RC(X)
EASY618-AC-RC	EASY620-DC-TE	
	EASY200-EASY	

Edition date	Page	Description	New	Modification	Omitted
08/00	Entire AWB	Type designations and illustrations adapted to new “easy” models.			
	11	Type reference	×		
	45	Warning	×		
	200	EMC		×	
	202, 204,	Column added for “easy”-DA	×		
	206	Short-circuit rating		×	
	207	UL/CSA		×	

Contents

1	Instructions for Use	5
	Target readership	5
	Proper use	5
	Hazard categories and warnings	6
	Safety instructions	7
	Device designation	7
2	“easy”	9
	Overview	9
	Versions	10
	“easy” operating principles	12
3	Installation	21
	Mounting	21
	Connecting the expansion device	24
	Terminals	25
	Connecting the power supply	25
	Connecting the inputs	28
	Connecting the outputs	39
	Connecting relay outputs	39
	Connecting transistor outputs	41
	Expanding inputs/outputs	44
4	Commissioning	47
	Switching on	47
	Setting the menu language	47
	“easy” operating modes	48
	Creating your first circuit diagram	49

5	Drawing a Circuit Diagram with “easy”	59
	Operation of “easy”	59
	Working with contacts and relays	64
	Function relay	77
	Timing relays	84
	Counter relays	90
	Time switch	93
	Analog comparators	98
	Text display	103
	Jumps	105
	Example circuits	108
6	Loading and Saving Circuit Diagrams	125
	Memory card	126
	EASY-SOFT	130
7	“easy” Settings	133
	Password protection	133
	Changing the menu language	139
	Changing parameters	140
	Setting the time	143
	Changing between winter/summer time (DST)	144
	Activating debounce (input delay)	145
	Activating and deactivating P buttons	146
	Startup behaviour	147
	Behaviour when the circuit diagram is deleted	149
	Behaviour during uploading and downloading to the card or PC	149
	Possible faults	149
8	Retention	151
	Requirements	151
	Setting retention	152
	Deleting retentive actual values	153
	Transfer retentive behaviour	154
	Retentive auxiliary relays (markers)	156
	Retentive timing relay	161
	Retentive Up/down counters C7, C8	170

9 Inside “easy”	175
“easy” circuit diagram cycle	175
Determining the cycle time of “easy” circuit diagrams	177
Delay times for inputs and outputs	184
Monitoring for short-circuit/Overload with EASY..-D.-T..	187
Expanding EASY600	190
10 What Happens If ...?	193
Message from the “easy” system	194
Possible situations when creating circuit diagrams	195
Event	196
11 Technical Data	197
General	197
Power supply	202
Inputs	203
Relay outputs	206
Transistor outputs	208
Cycle time	210
Glossary	213
Index	217

1 Instructions for Use

Target readership

“easy” must only be installed and connected up by trained electricians or other persons who are familiar with the installation of electrical equipment.

Specialist electrical training is needed for commissioning and creating circuit diagrams. Parts of the system can be damaged and persons put at risk if “easy” is connected or programmed incorrectly, causing active components such as motors or pressure cylinders to start up.

Proper use

“easy” is a programmable control and timing relay which is used in place of relay and contactor controls. It must not be used unless it has been correctly installed.

“easy” is designed to be installed in an enclosure, switch cabinet or distribution board. Both the power feed and the signal terminals must be laid and covered so as to prevent accidental contact.

The installation must conform to regulations for electromagnetic compatibility (EMC).

The starting up of “easy” should not cause any hazards arising from controlled devices, such as unexpected motor startups or power ups.

Improper use

“easy” should not be used as a substitute for safety-related controls such as burner or crane controls, emergency-stop or two-hand safety controls.

Hazard categories and warnings

In this manual, the possible hazards are divided into three different categories.



Warning

Warns you of a hazardous situation that could result in severe injury or even death if safety instructions and measures to prevent the risk are not followed.



Caution

Refers to a hazardous situation that could result in injury or damage if care is not taken.



Note

Indicates a hazardous situation that could result in damage to the product or components of connected systems if care is not taken.

Information and tips



Information and tips contain extra useful details relating to features that go beyond the scope of the particular chapter.

Safety instructions



DANGER of electric shock

Never carry out electrical work on the device while the power supply is switched on.

Always follow the safety rules:

Switch off and isolate

Secure against reclosing

Ensure that the device is no longer live

Cover adjacent live parts

Device designation

This manual uses the following abbreviated designations for different easy models:

EASY412 for
EASY412-AC-... and EASY412-D-...

EASY600 for
EASY6..-AC-RC(X)
EASY6..-DC-.C(X)

“easy”-AC for
EASY412-AC-..
EASY6..-AC-RC(X)

“easy”-DC for
EASY412-DC-..
EASY620/621-DC-.C(X)

“easy”-DA for
EASY412-DA-RC

2 “easy”

Overview

“easy” is an electronic control relay with built-in logic, timer, counter and time switch functions. “easy” is a control and input device rolled into one that can perform many different tasks in building and machine applications.

Circuit diagrams are connected up using ladder diagrams, and each element is entered directly via the “easy” display. For example, you can:

- Connect make and break contacts in series and in parallel

- Connect output relays and markers,

- Define outputs as relays, impulse relays or latching relays

- Select timing relays with different functions

- Assign eight up and down counters

- Display any texts with variables,

- Track the flow of current in the circuit diagram

- Load, save and password-protect circuit diagrams

Models with the type designation

“EASY...-...-...-C(X)” offer an additional four 7-day time switches each allowing up to four On and Off times.

The DC versions can receive analog signals at two inputs and evaluate the signals with eight analog comparators.

If you prefer to wire up “easy” from a PC, then use EASY-SOFT. EASY-SOFT allows you to create and test your circuit diagram on the PC. EASY-SOFT enables you to print out your circuit diagram in DIN, ANSI or “easy” format.

“easy” basic units at a glance

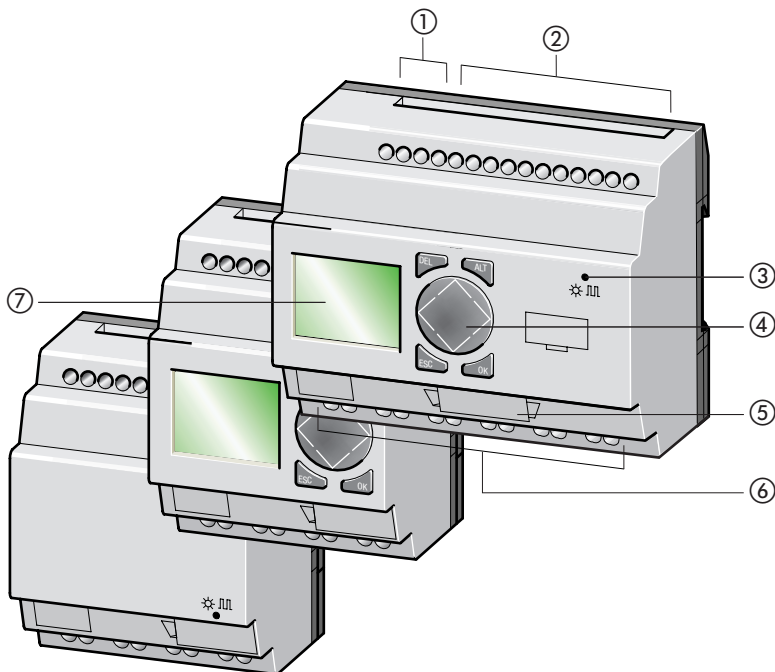

Figure 1: Device overview

- ① Power supply
- ② Inputs
- ③ Status LED
- ④ Buttons
- ⑤ Interface socket for memory card or PC interface cable
- ⑥ Outputs
- ⑦ LCD display

Type code

EASY - x x x - x x - x x x x

LCD display: X = No display

Time switch: C = Available

Output type:

R = Relay (max. 8 A)

T = Transistor (0.5 A, parallel connection possible up to 2 A)

Supply voltage, device and inputs

AC = 100, 120, 230, 240 V AC

DC = 24 V DC (2 inputs, also usable as analog inputs, 0 to 10

DA = 12 V DC

Number of inputs/outputs (+ expansion)

12 = 8 I/4 O

18 = 12 I/6 O

19 = 12 I/6 O + expansion

20 = 12 I/8 O

21 = 12 I/8 O + expansion

Space unit

2 = 35.5 mm

4 = 71.5 mm

6 = 107.5 mm

“easy” control relay

“easy”

“easy” operating principles

“easy” operating buttons



DEL: Delete object in circuit diagram

ALT: Special functions in circuit diagram

Cursor buttons < > ^ ∨:

Move cursor

Select menu items

Set contact numbers, contacts and values

OK: Next menu level, store your entry

ESC: Last menu level, Cancel

Moving through menus and choosing values



and

Show System menu



Go to next menu level

Select menu item

Store your entry



Return to last menu level

Cancel your entry since the last **OK**

^ ∨ Change menu item

Change value

< > Change position

P button function (if enabled):

< Input P1,

^ Input P2

> Input P3,

∨ Input P4



Selecting the main menu and system menu

Status display

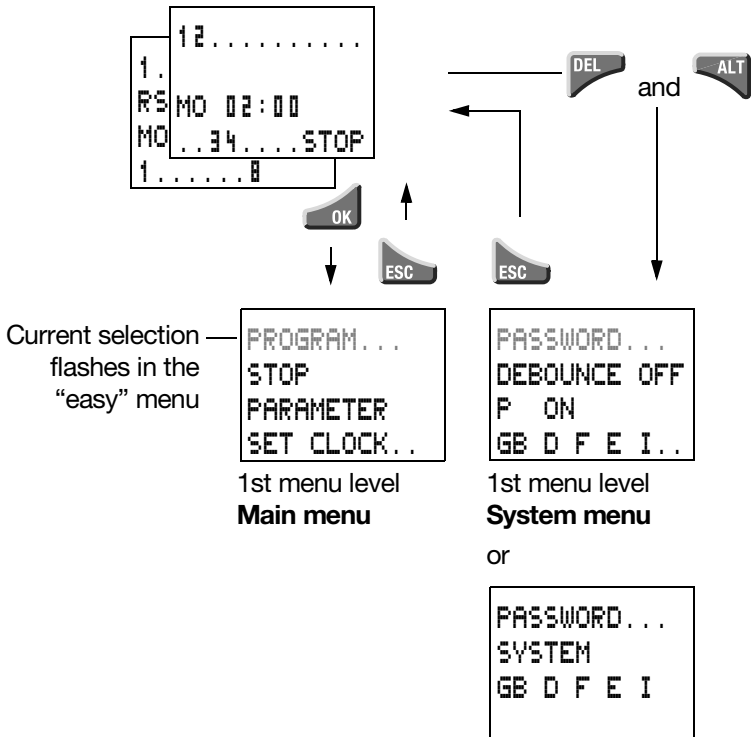

“easy”

EASY412 status display

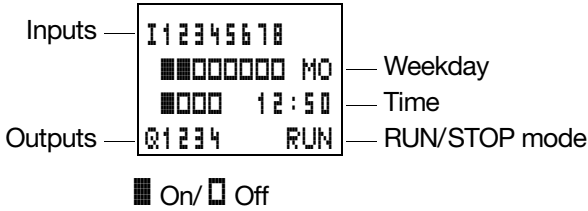

EASY600 status display

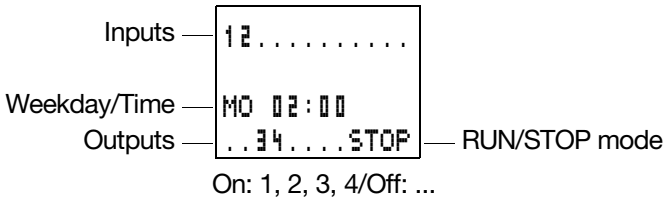

Status display for expansion

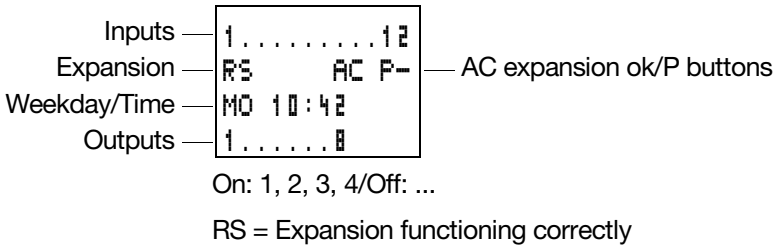

EASY600 advanced status display

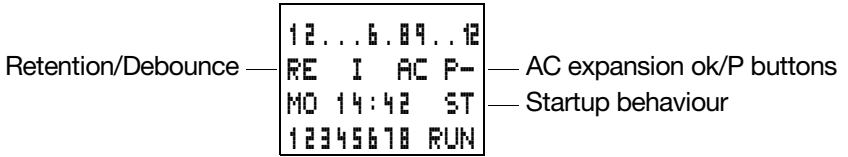

- RE = Retention switched on
- I = Debounce switched off
- AC = AC expansion functioning correctly
- DC = DC expansion functioning correctly
- GW= Bus coupling module
- ST = When the power supply is switched on, EASY switches to Stop mode

“easy” LED signals

EASY412-..-..X, EASY600 and “easy”-E feature an LED on the front indicating the status of the power supply as well as whether Run or Stop mode is active (see Figure 1 on page 10).

LED OFF	No power supply
LED continuously lit	Power supply present, Stop mode
LED flashing	Power supply present, Run mode

“easy”

Menu structure

Main menu without password protection

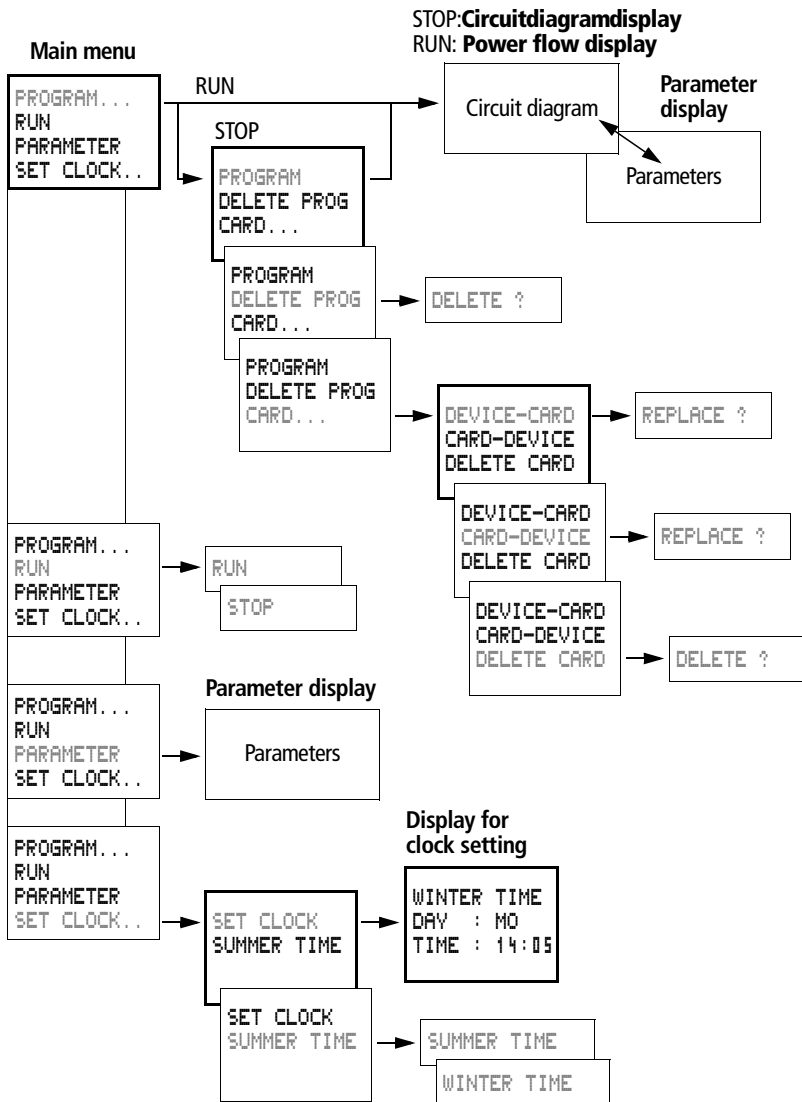

Main menu with password protection

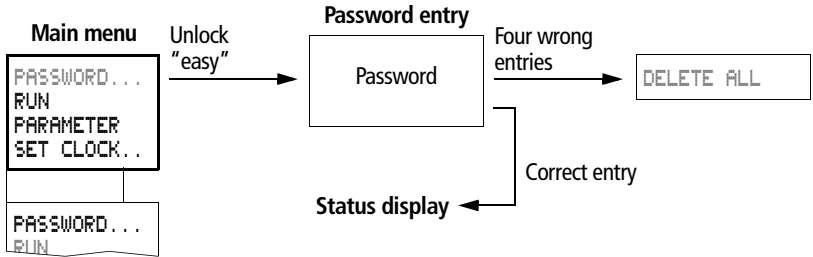

EASY412 system, operating system V 1.0

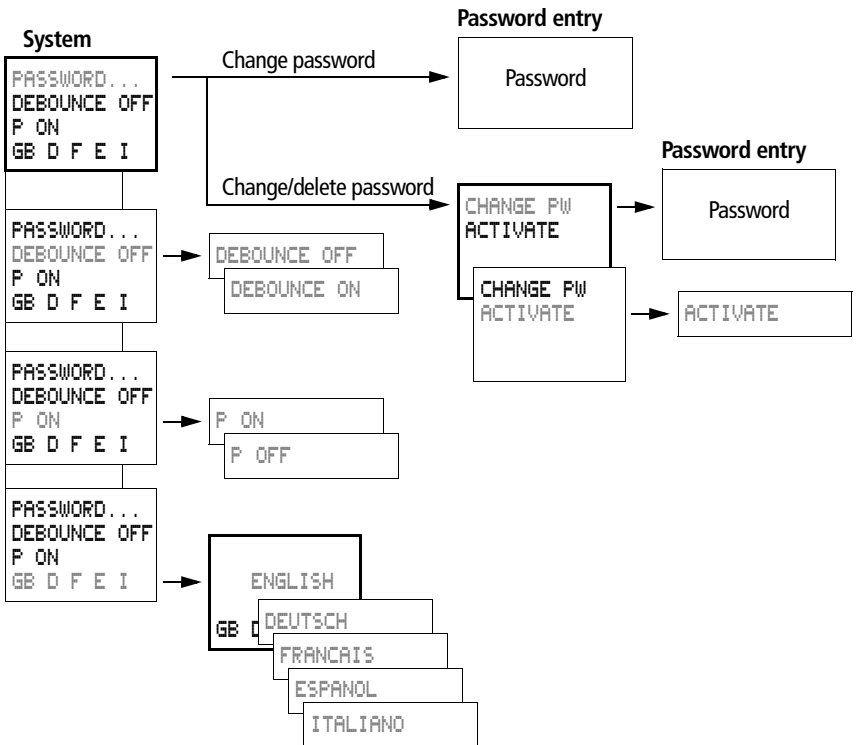

“easy”

EASY412 System menu, from operating system V 1.2, EASY600

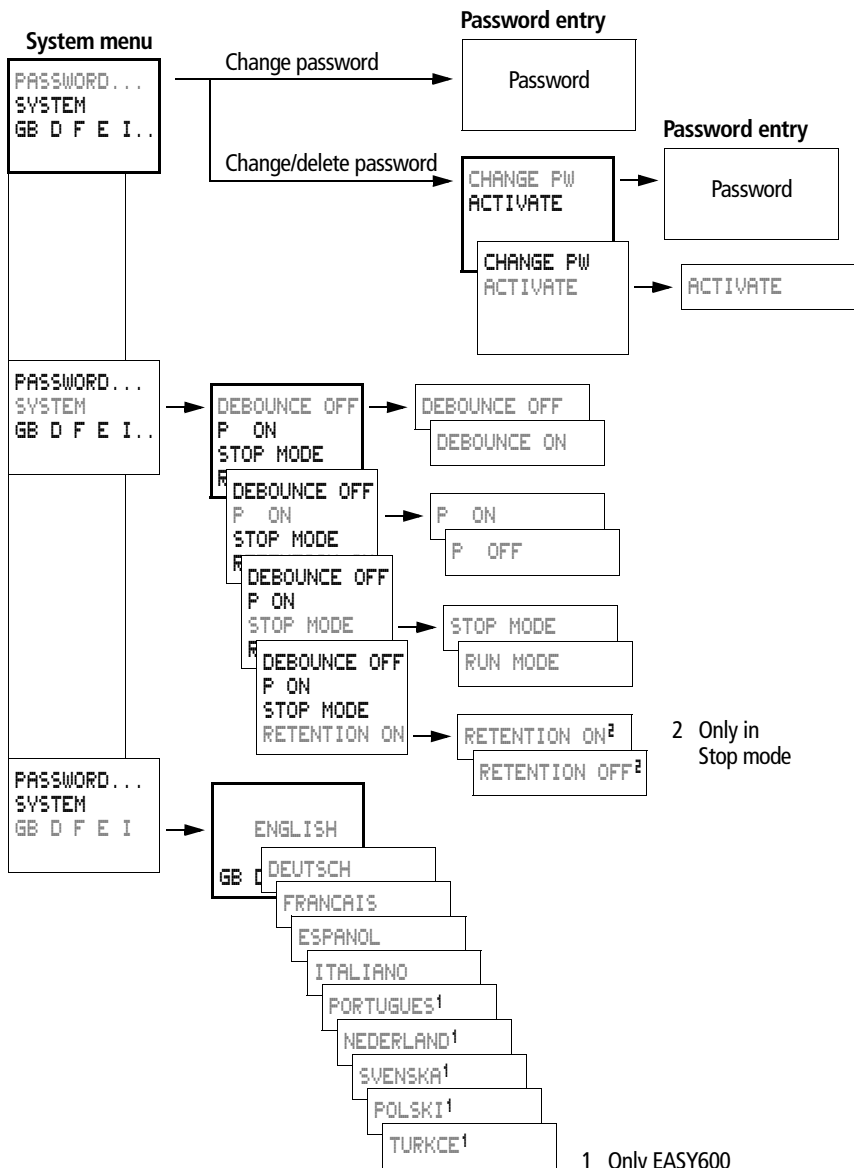

Selecting or toggling between menu items

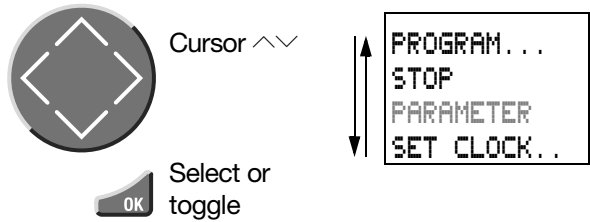

Cursor display

The cursor blinks:

Full cursor █/█:

Move cursor with $\langle \rangle$,
In circuit diagram also
with $\wedge \vee$

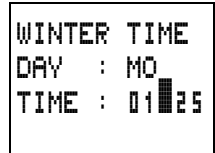

Value M/M

Change position with $\langle \rangle$
Change values with $\wedge \vee$

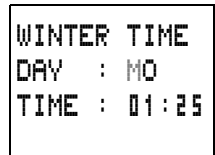

Blinking values/menus are shown grey in this manual.

Setting values

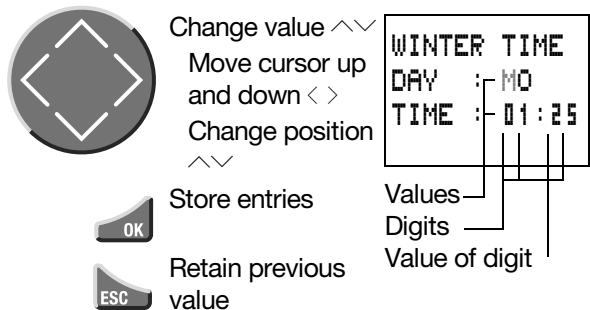

3 Installation

“easy” must only be installed and wired up by trained electricians or other persons familiar with the installation of electrical equipment.



Danger of electric shock

Never carry out electrical work on the device while the power supply is switched on.

Always follow the safety rules:

- Switch off and isolate

- Secure against reclosing

- Ensure that the device is no longer live

- Cover adjacent live parts

“easy” is installed in the following order:

- Mounting

- Wiring up the inputs

- Wiring up the outputs

- Connecting the power supply

Mounting

Install “easy” in an enclosure, switch cabinet or distribution board so that the power feed and terminal connections cannot be touched accidentally during operation.

Clip “easy” onto a DIN EN 50 022 top-hat rail or fix “easy” in place using mounting feet. “easy” can be mounted either vertically or horizontally.



When using “easy” with expansion units, connect the expansion concerned before mounting (see page 24).

For ease of wiring, leave a gap of at least 3 cm between “easy” terminals and the wall or adjacent devices.

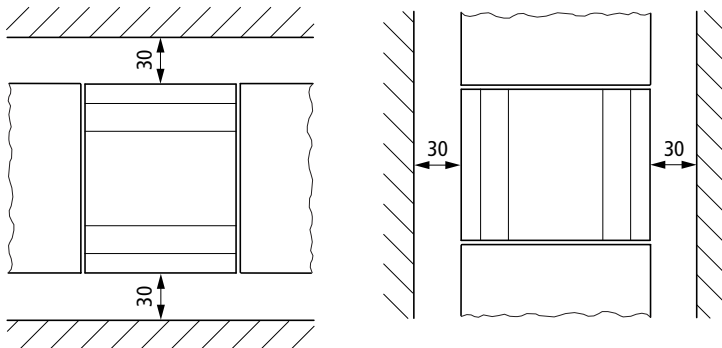

Mounting on top-hat rail

- ▶ Hook “easy” to the top edge of the top-hat rail and hinge into place while pressing down slightly as shown by the arrows. Press down lightly on both the device and the top-hat rail until “easy” snaps over the lower edge of the top-hat rail.

“easy” will clip into place and will be secured by the built-in spring mechanism without needing screws.

- ▶ Check that “easy” is seated firmly.

“easy” is mounted vertically on a top-hat rail in the same way.

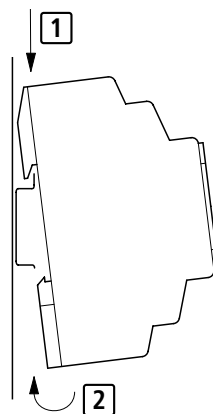

Mounting on a mounting plate

For a screw fixing, use a mounting plate that can be fitted on the back of “easy”. Mounting feet can be ordered as an accessory.

EASY200-EASY: EASY412:

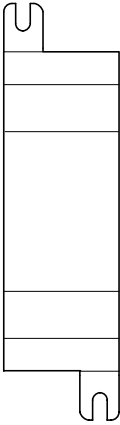

EASY600:

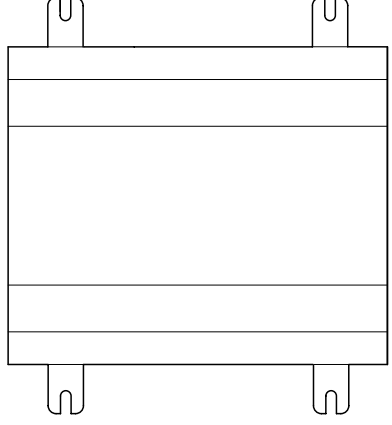
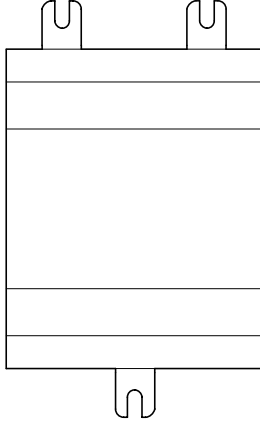

Connecting the expansion device

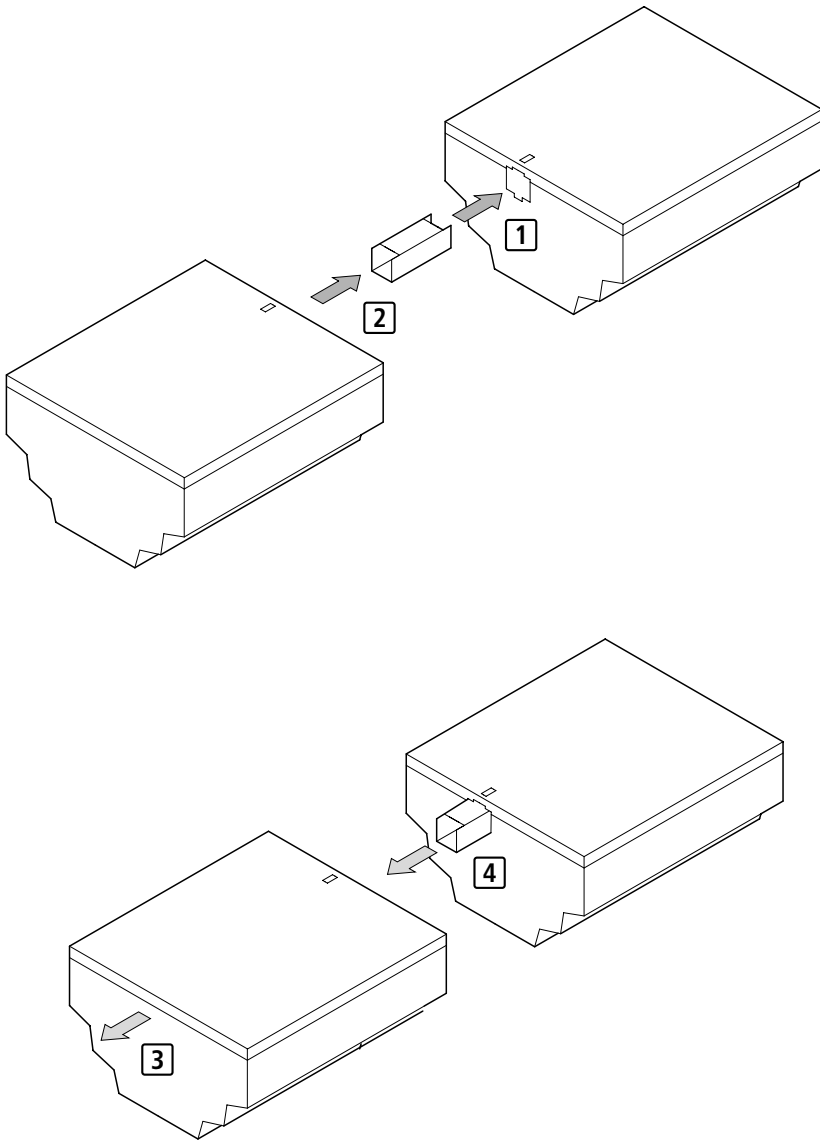

Terminals

Tools

Slot-head screwdriver, width 3.5 mm, tightening torque 0.6 Nm.

Cable cross-sections

Solid 0.2 to 4 mm²

Flexible with ferrule: 0.2 (AWG 24) to 2.5 mm² (AWG 12)

Connecting the power supply



For the technical data of both versions, “**easy**”-**DC** with 24 V DC and “**easy**”-**AC** with standard voltages of 100 V to 240 V AC, refer to chapter 11 from page 197.

The **EASY600** models run a system test for five seconds after the power supply has been switched on. Either Run or Stop mode will be activated after these five seconds, depending on the default setting.

AC units

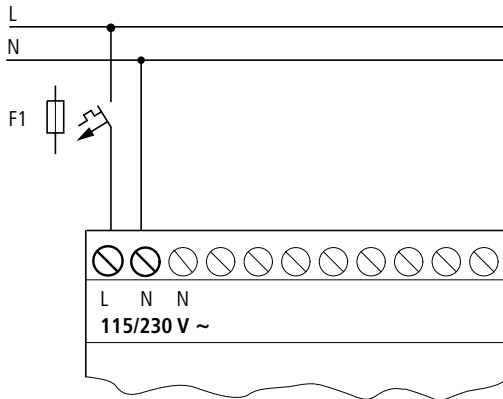

EASY...-AC-E

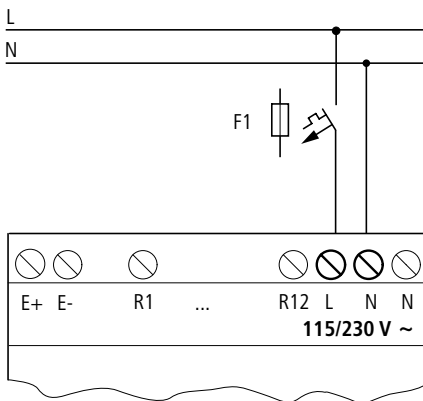

DANGER of electric shock with “easy”-AC units!

With “easy” NEVER swap over the live (L) and neutral conductor (N) terminals as the interface will then carry the live (L) potential power of 230 V/115 V. There is a danger of electric shock if the plug is not properly connected or if conductive objects are inserted into the socket.



Attention

A short current surge will be produced when switching on for the first time. Do not switch on “easy” via Reed contacts since these may burn or melt.

DC and DA models

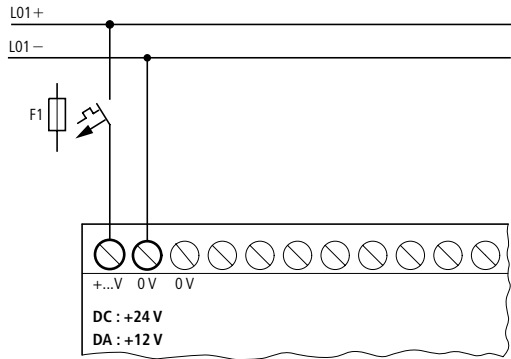

EASY...-DC-.E

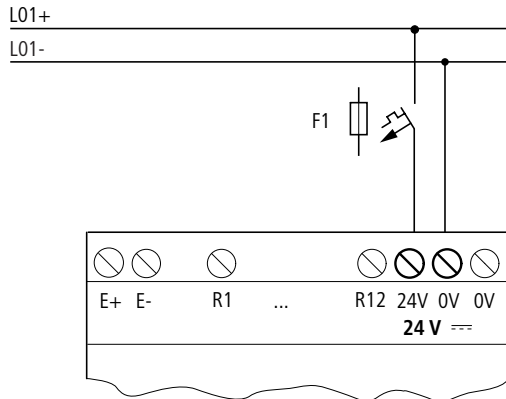

“easy” DC is protected against polarity reversal. To ensure that “easy” works correctly, ensure that the polarity of each terminal is correct.

Cable protection

Both “easy” AC and DC versions require cable protection (F1) rated for at least 1 A (slow).



When “easy” is switched on for the first time, its power supply circuit behaves like a capacitor. Use an appropriate device for switching on the power supply and do not use any reed relay contacts or proximity switches.

Connecting the inputs

“easy” inputs switch electronically. Once you have connected a contact via an input terminal, you can reuse it as a contact in your “easy” circuit diagram as often as you like.

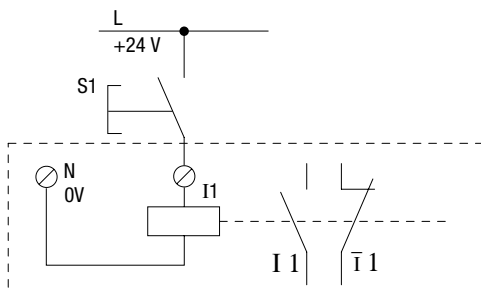

Connect contacts such as push-button actuators or switches to “easy” input terminals.

Connecting “easy”-AC inputs



Caution

For “easy”-AC, connect the inputs to the same line as the power feed in accordance with VDE, IEC, UL and CSA safety regulations. Otherwise, “easy” will not detect the switching level or may be damaged by overvoltage.

Connecting the inputs

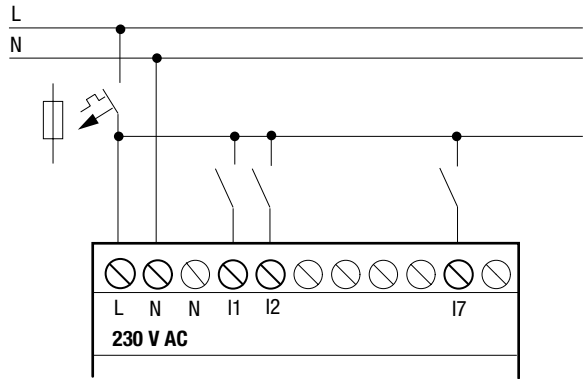

"easy"-AC

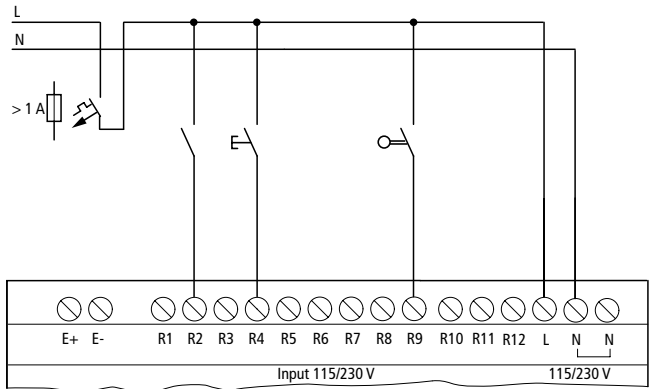

EASY...-AC-.E

Connect the inputs, for example, to push-button actuators, switches or relay/contactors contacts.

Input signal voltage range:

OFF signal: 0 V to 40 V

ON signal: 79 V to 264 V

Input current

R1 to R12

I1 to I6, I9 to I12: 0.5 mA/0.25 mA
at 230 V/115 V

I7, I8: 6 mA/4 mA at
230 V/115 V

Cable lengths

Severe interference to cables can cause inputs to signal 1 without a proper signal being applied.

Observe therefore the following maximum cable lengths:

R1 to R12,

I1 to I6, I9 to I12: 40 m without additional
circuit

I7, I8: 100 m without additional
circuit

For longer lengths connect in series a diode (e.g. 1N4007) for 1 A, min. 1000 V reverse voltage, to the “easy” input. Ensure that the diode is pointing towards the input as shown in the circuit diagram, otherwise “easy” will not detect 1 status.

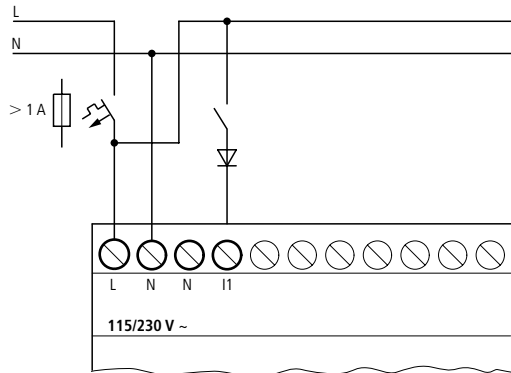

“easy”-AC

Neon bulbs with a maximum residual current of 2 mA/1 mA at 230 V/115 V can be connected to I7 and I8.



Always use neon bulbs that are operated with a separate N connection.



Caution

Do not use reed relay contacts on I7, I8. These may burn or melt due to the high inrush current of I7, I8.

Two-wire proximity switches have a residual current on 0. If this residual current is too high, the input of “easy” may only detect the 1 signal.

Therefore use inputs I7, I8. An additional input circuit is required if more inputs are used.

Increasing the input current

The following input circuit can be used in order to prevent interference and also when using two-wire proximity switches:

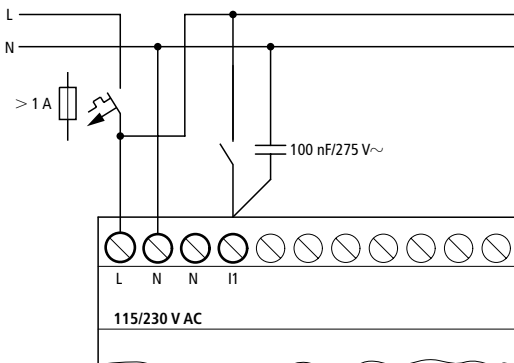

When using a 100 nF capacitor the drop-off time of the input increases by 80 (66.6) ms at 50 (60) Hz.

A resistor can be connected in series upstream of the circuit shown in order to restrict the inrush current.

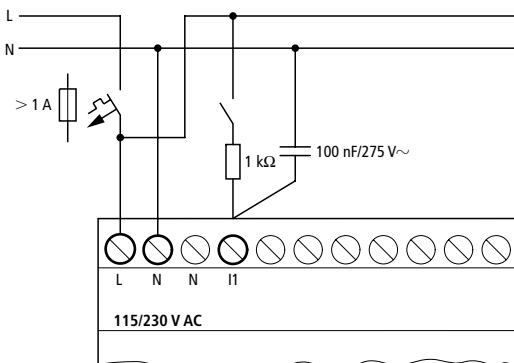

Connecting the inputs

Complete devices for increasing the input current are available, for example, from Felten & Guillaume.

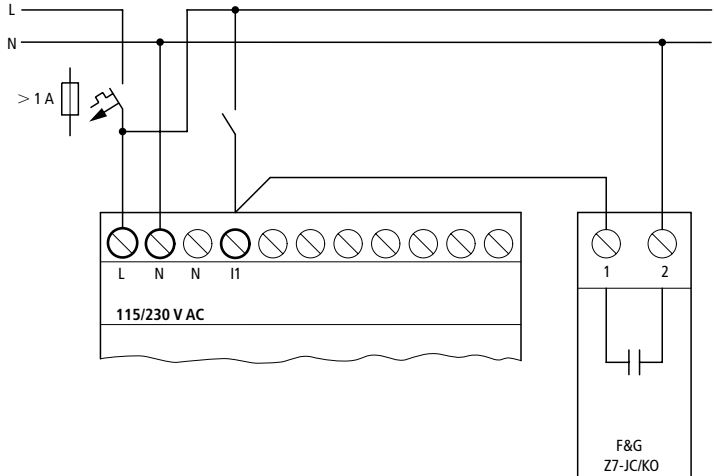

The increased capacitance increases the drop-out time by approx. 300 ms.

Connecting “easy”-DC and “easy”-DA inputs

Use input terminals I1 to I12 to connect push-button actuators, switches or 3 or 4-wire proximity switches. Given the high residual current, do not use 2-wire proximity switches.

Input signal voltage range

OFF signal: 0 V to 5 V

ON signal: 15 V to 28.8 V

Input current

“easy”-DC:

I1 to I6, I9 to I12: 3.3 mA at 24 V,
R1 to R12

I7, I8: 2.2 mA at 24 V

“easy”-DA:

I1 to I6: 3.3 mA at 12 V,

I7, I8: 1.1 mA at 12 V

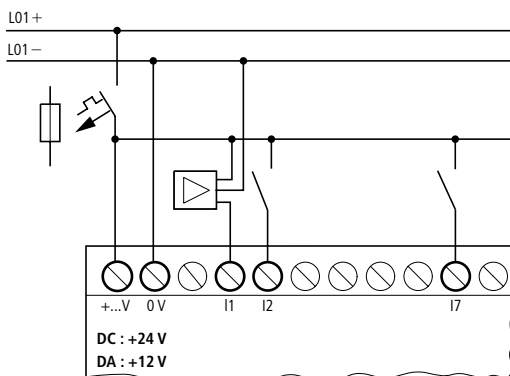

“easy”-DC, “easy”-DA

Connecting the inputs

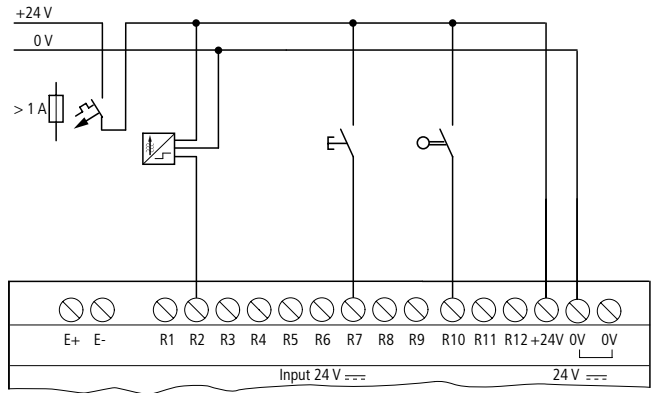

EASY...-DC-.E

Connecting analog inputs

Inputs I7 and I8 can also be used to connect analog voltages ranging from 0 V to 10 V.



Caution

Analog signals are more sensitive to interference than digital signals. Consequently, more care must be taken when laying and connecting the signal lines.

Incorrect switching states may occur if they are not connected correctly.

Use screened twisted pair cables to prevent interference with the analog signals.

For short cable lengths, ground the screen at both ends using a large contact area. If the cable length exceeds 30 m or so, grounding at both ends can result in equalisation currents between the two grounding points and thus in the interference of analog signals. In this case, only ground the cable at one end.

Do not lay signal lines parallel to power cables.

Connect inductive loads to be switched via “easy” outputs to a separate power feed, or use a

suppressor circuit for motors and valves. If loads such as motors, solenoid valves or contactors are operated with “easy” via the same power feed, switching may result in interference on the analog input signals.

The following four circuits contain examples of applications for analog value processing.



Ensure that the reference potential is connected. Connect the 0 V of the power supply unit for the different setpoint potentiometers and sensors shown in the examples to the 0 V of the “easy” power feed.

Setpoint potentiometers

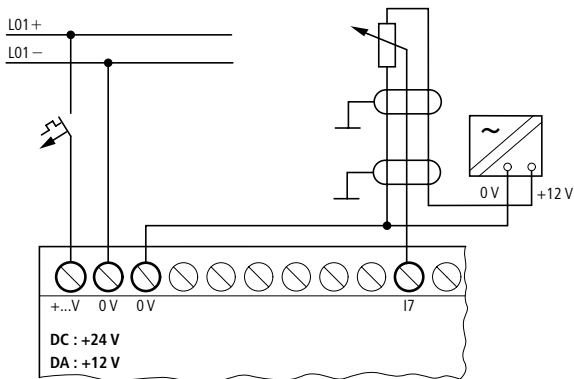

Use a potentiometer with a resistance of $\leq 1 \text{ k}\Omega$, e.g. $1 \text{ k}\Omega$, 0.25 W .

Connecting the inputs

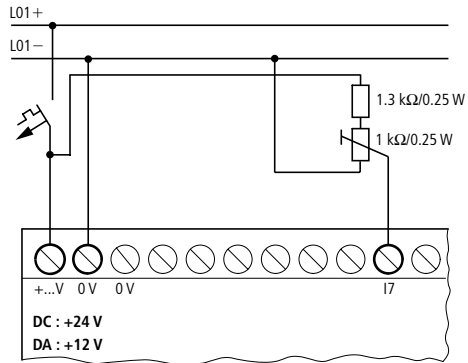

Light intensity sensors

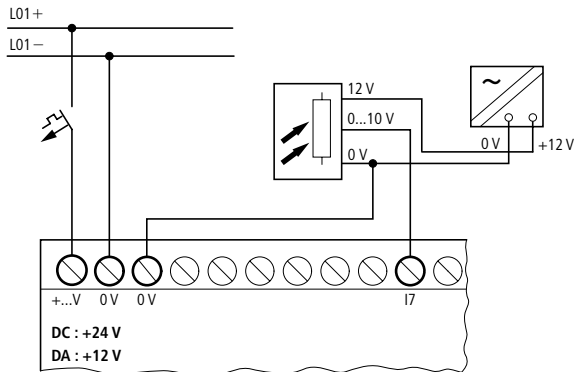

Temperature sensors

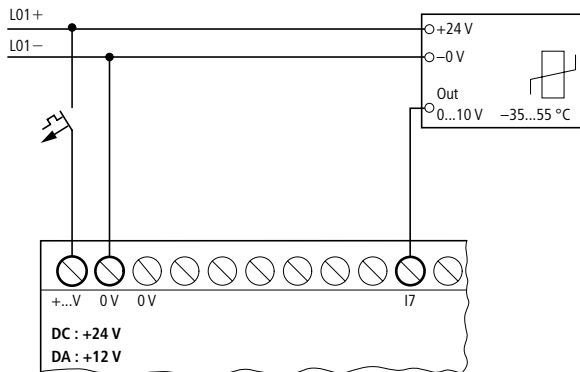

20 mA sensors

4 to 20 mA (0 to 20 mA) sensors can be connected easily without any problem using an external 500 Ω resistor.

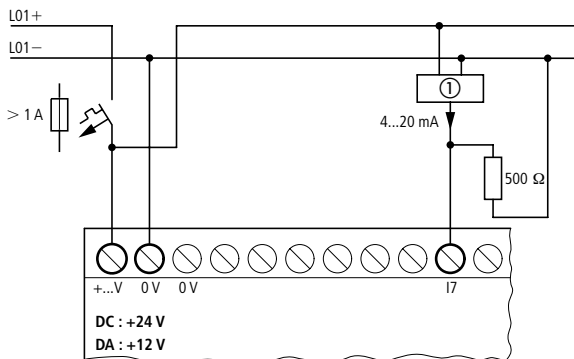

① Analog sensor

The following values apply:

$$4 \text{ mA} = 0.2 \text{ V}$$

$$10 \text{ mA} = 4.8 \text{ V}$$

$$20 \text{ mA} = 9.5 \text{ V}$$

(Based on $V = R \times I = 478 \Omega \times 10 \text{ mA} \sim 4.8 \text{ V}$).

Connecting the outputs

The Q output terminals function inside “easy” as isolated contacts.

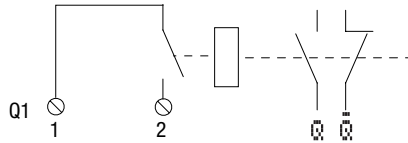

In the “easy” circuit diagram the relay coils are controlled via the corresponding output relays Q1 to Q4 or Q1 to Q8 (Q6). You can use the signal states of the output relays as make or break contacts in the “easy” circuit diagram to provide additional switching conditions.

The relay or transistor outputs are used to switch loads such as fluorescent tubes, filament bulbs, contactors, relays or motors. Check the technical thresholds and output data before installing such devices (see chapter 11, from page 197).

Connecting relay outputs

EASY412-..-R..

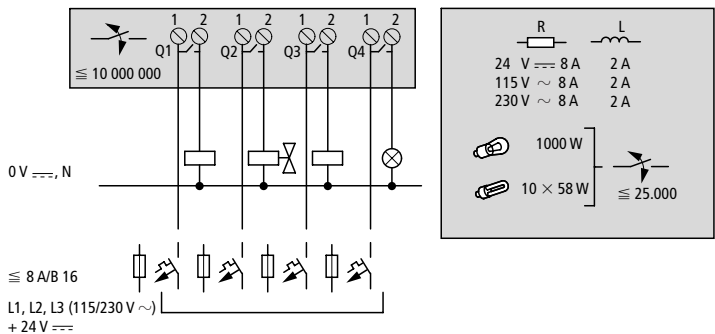

EASY61.-.-R..

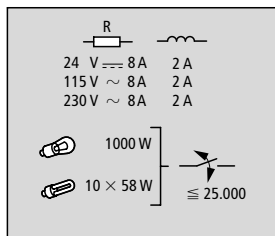
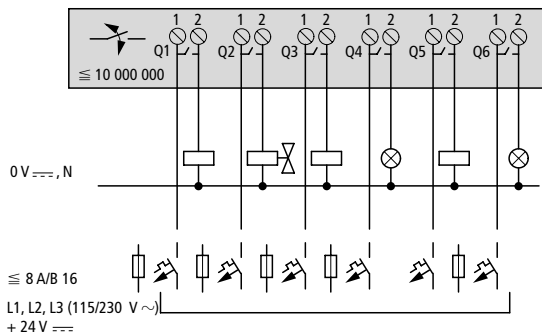

EASY618.-.-RE

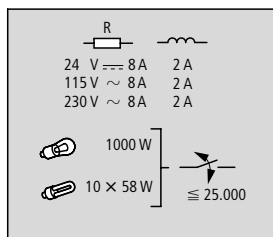
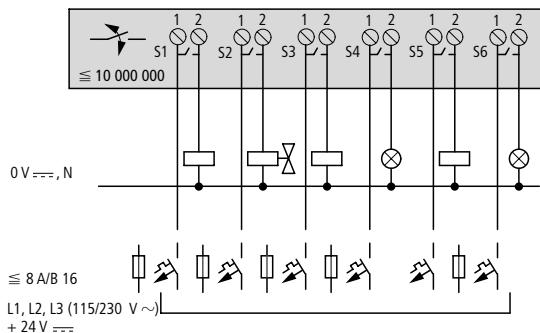

Unlike the inputs, the outputs can be connected to different lines.



Do not exceed the maximum voltage of 250 V AC on a relay contact. If the voltage exceeds this threshold, flashover may occur at the contact, resulting in damage to the device or a connected load.

Connecting transistor outputs

EASY412-...-T..

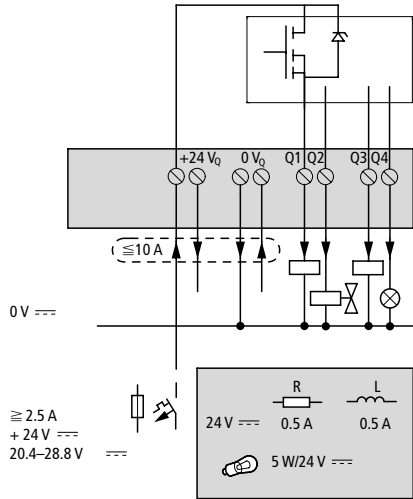

EASY62-...-T..

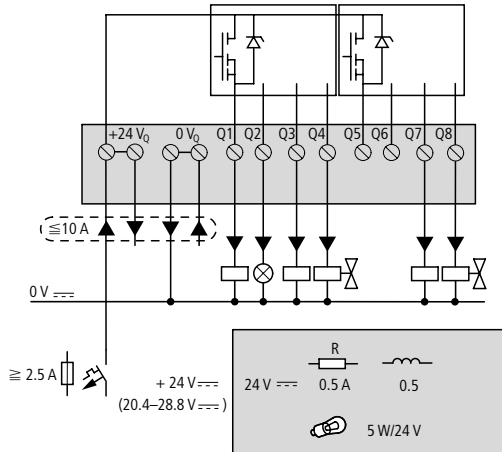

EASY620-...-TE

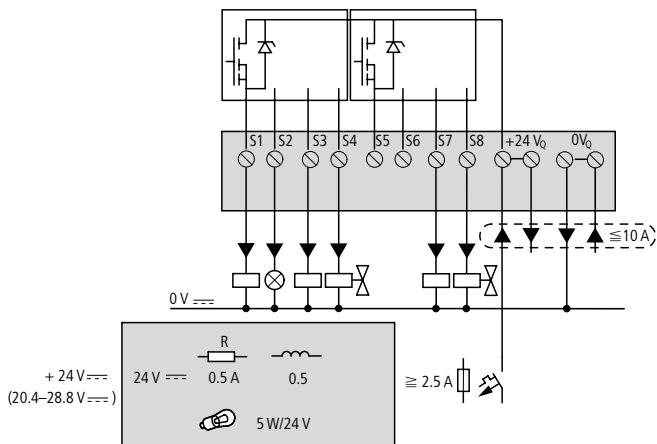

Parallel connection:

Up to four outputs can be connected in parallel in order to increase the power. The output current will increase in this case to a maximum of 2 A.



Caution

Outputs may only be connected in parallel within a group (Q1 to Q4 or Q5 to Q8, S1 to S4 or S5 to S8), such as Q1 and Q3 or Q5, Q7 and Q8. Outputs connected in parallel must be switched at the same time.



Caution

Please note the following when switching off inductive loads. Suppressed inductive loads cause less interference in the entire electrical system. For optimum suppression the suppressor circuits are best connected directly to the inductive load.

If inductive loads are not suppressed, only one inductive load should be switched off at any one time so as to prevent the driver blocks from possibly overheating. If in the event of an emergency stop the +24 V DC power supply is to be switched off by means of a contact, and if this would mean switching off more than one controlled output with an inductive load, then you must provide suppressor circuits for these loads (see the following diagrams).

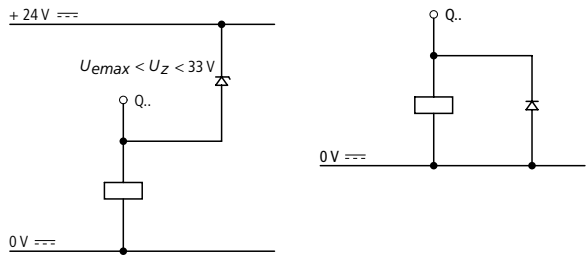

Behaviour in the event of short-circuits/overload

Should a short circuit or overload occur on a transistor output, this output will switch off. The output will switch on up to maximum temperature after the cooling time has elapsed. This time depends on the ambient temperature and the current involved. If the fault condition persists, the output will keep switching off and on until the fault is corrected or until the power supply is switched off.

Monitoring for short-circuit/overload see chapter 9, from page 175.

Expanding inputs/ outputs

You can add expansion units to the following “easy” models in order to increase the number of inputs and outputs:

Expandable “easy” basic units	Expansion units	
EASY619-...-R.. EASY621-...-T..	EASY618-...-RE	12 inputs AC, 6 relay outputs
	EASY620-...-TE	12 inputs DC, 8 transistor outputs
Special expansion units see current catalogue		

Local expansion

Local expansion units are connected directly next to the basic unit.

- ▶ Connect the “easy” expansion unit via the “EASY-LINK” plug connector.

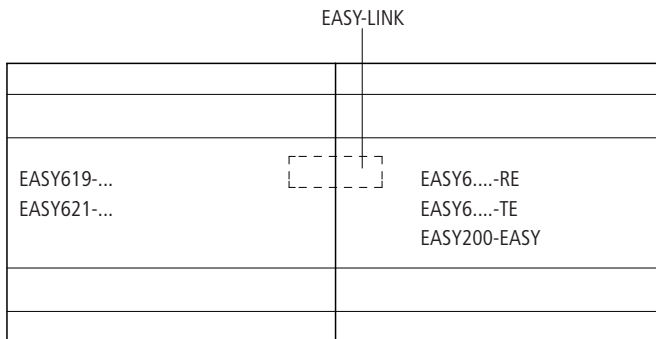



The following electrical separation is implemented between the EASY6...-C. basic unit and the expansion device (separation always in local connection of expansion unit)

Simple isolation 400 V AC (+10 %)

Safe isolation 240 V AC (+10 %)

Units may be destroyed if the value 400 V AC +10 % is exceeded, and may cause the malfunction of the entire system or machine!



Basic unit and expansion unit can be provided with different DC power supplies.

Remote expansion

Remote expansion units can be installed and run up to 30 m away from the basic unit.



Warning

The two-wire or multi-core cable between units must have the necessary insulation voltage required for the installation environment concerned. In the event of a fault (earth leakage, short-circuit) serious damage or injury to persons may otherwise occur.

A cable such as NYM-0 with a rated operational voltage of $U_e = 300/500$ V AC is normally sufficient.

Installation

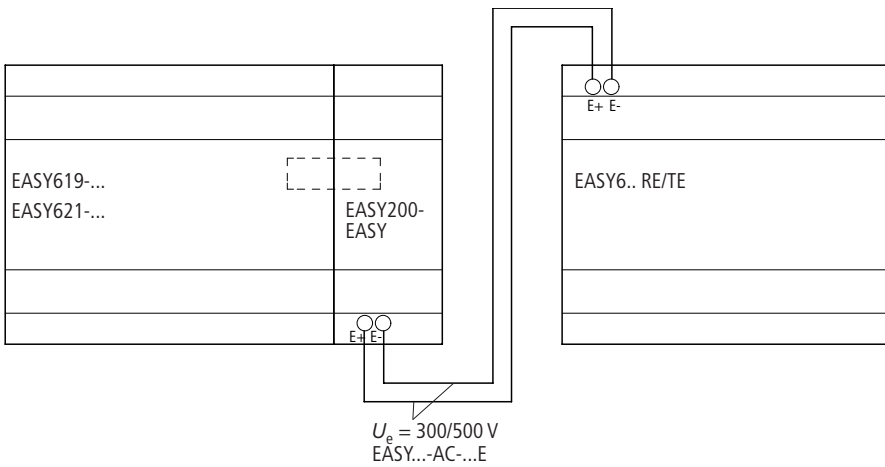

Terminals “E+” and “E-” of the EASY200-EASY are protected against short-circuits and polarity reversal.
Functionality is only ensured if “E+” is connected with “E+” and “E-” with “E-”.

4 Commissioning

Switching on

Before switching on “easy”, check that you have connected the power supply terminals and inputs correctly:

24 V DC version:

Terminal +24 V: Voltage +24 V

Terminal 0 V: Voltage 0 V

Terminals I1 to I12, R1 to R12:

Actuation via +24 V

230 V AC version

Terminal L: Phase conductor L

Terminal N: Neutral conductor

Terminals I1 to I12, R1 to R12:

Actuation via phase conductor L

If you have already integrated “easy” into a system, secure any parts of the system connected to the working area to prevent access and ensure that no-one can be injured if, for example, motors start up unexpectedly.

Setting the menu language

When you switch on “easy” for the first time, you will be asked to select the menu language.

- Use the cursor buttons \wedge or \vee to select the language required.

GB English
D German
F French
E Spanish
I Italian



EASY600 also supports the following languages:

- Portuguese
- Dutch
- Swedish
- Polish
- Turkish

► Press **OK** to confirm your choice or press **ESC** to exit the menu.

“easy” will then switch to the Status display.



You can change the language setting at a later date, if you wish, see chapter 7, page 133. If you do not set the language, “easy” will display this menu and wait for you to select a language every time you switch on.

“easy” operating modes

“easy” has two operating modes - Run and Stop.

In Run mode “easy” continuously processes a stored circuit diagram until you select Stop or disconnect the power. The circuit diagram, parameters and the “easy” settings are retained in the event of a power failure. All you will have to do is reset the real-time clock after the back-up time has elapsed. Circuit diagram entry is only possible in Stop mode.



Caution

In Run mode “easy” will immediately run the saved circuit diagram in the unit when the power supply is switched on. This will happen unless Stop mode was set as startup mode. In Run mode outputs are activated according to the switch logic involved.

In the case of “easy” models with an LCD display, a circuit diagram on a fitted memory card is not run

automatically. The circuit diagram must first be transferred from the memory card to the “easy” unit.

In Run mode “easy”-X models load the circuit diagram on the memory card automatically and run it immediately.

Creating your first circuit diagram

The following small circuit diagram takes you step by step through wiring up your first “easy” circuit diagram. In this way you will learn all the rules, quickly enabling you to use “easy” for your own projects.

As with conventional wiring, you use contacts and relays in the “easy” circuit diagram. With “easy”, however, you no longer have to connect up components individually. At the push of a few buttons, the “easy” circuit diagram produces all the wiring. All you have to do is then connect any switches, sensors, lamps or contactors you wish to use.

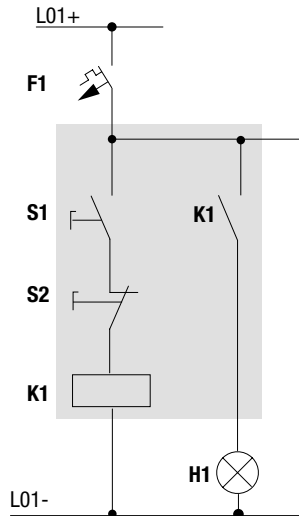

In the following example, “easy” carries out all the wiring and performs the tasks of the circuit diagram highlighted above.

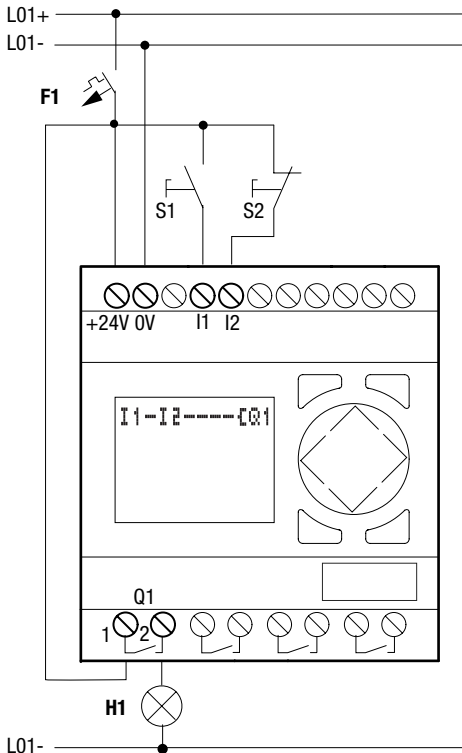

Starting point: the Status display

When you switch on “easy”, it opens the Status display immediately to show the switching state of the inputs and outputs. It also indicates whether “easy” is already running a circuit diagram.



The examples were written without the use of expansion units. If an expansion unit is connected, the Status display will first show the status of the basic unit and then the status of the expansion unit before showing the first selection menu.

EASY412:

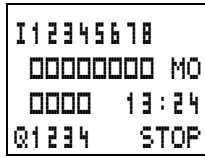

EASY600:

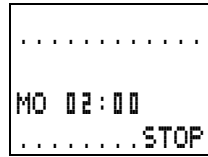

► Press **OK** to switch to the main menu.

Press **OK** to move to the next menu level, and press **ESC** to move one level back.



OK has two other functions:

Press **OK** to save modified settings.

In the circuit diagram, you can also press **OK** to insert and modify contacts and relay coils.

In this case “easy” must be in Stop mode

► Press 2 × **OK** to enter the circuit diagram display via menu points “PROGRAM...” -> PROGRAM.
This is where you will create the circuit diagram.

Circuit diagram display

The circuit diagram display is currently empty. The cursor is flashing at the top left, which is where you will start to create your diagram.

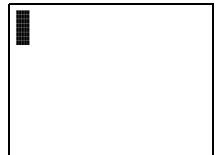

Using the cursor buttons $\wedge \vee$ $\langle \rangle$ move across the hidden grid lines Circuit diagram grid lines.

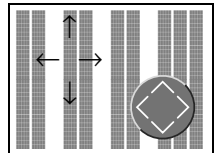

The first three double columns are the contact fields and the right-hand columns form the coil field. Each line is a circuit connection. “easy” will add the first contact automatically.

- ▶ Now try to wire up the following “easy” circuit diagram.

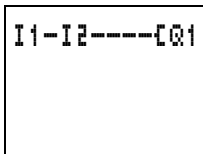

Switches S1 and S2 are at the input. “I1” and “I2” are the contacts for the input terminals.

Relay K1 is represented by the relay coil “[Q1”. The symbol “[” identifies the coil's function, in this case a relay coil acting as a contactor. Q1 is one of up to eight “easy” output relays.

From the first contact to the output coil

With “easy”, you work from the input to the output. The first contact is I1.

- ▶ Press **OK**.

“easy” inserts the first contact I1 at the cursor position.

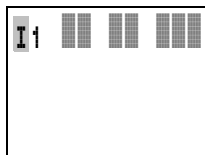

The I flashes and can be changed, for example, to a P for a button input using the cursor buttons ^ or v. However, nothing needs to be changed at this point, so...

- ▶ ...Press 2 x **OK** to move the cursor across the 1 to the next contact field.

You could also move the cursor to the next contact field using the cursor button >.

- ▶ Press **OK**.

Again, “easy” creates a contact I1 at the cursor position. Change the contact number to I2 so that break contact S2 can be connected to input terminal I2.

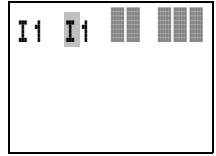

- ▶ Press **OK** so that the cursor jumps to the next position and press cursor button \wedge or \vee to change the number to 2.



Press **DEL** to delete a contact at the cursor position.

- ▶ Press **OK** to move the cursor to the third contact field.

You do not need a third relay contact, so you can now wire the contacts directly to the coil field.

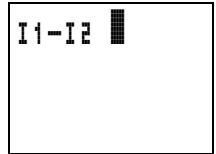

Wiring

“easy” displays a small arrow when creating the circuit diagram.

Press **ALT** to activate the arrow and press the cursor buttons \wedge \vee \langle \rangle to move it.



ALT also has two other functions depending on the cursor position:

From the left contact field, press **ALT** to insert a new, empty circuit connection.

Then press **ALT** to set the contact currently under the cursor to either a make or break contact.

The wiring arrow works between contacts and relays. When you move the arrow onto a contact or relay coil, it changes back to the cursor and can be reactivated with ALT if required.

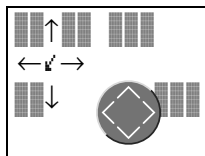

“easy” automatically wires adjacent contacts in a circuit connection up to the coil.

- ▶ Press **ALT** to “wire” the cursor from I2 through to the coil field.

The cursor changes into a flashing wiring arrow and automatically jumps to the next possible wiring position.

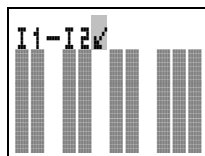

- ▶ Press the cursor button **>**. Contact I2 will be connected up to the coil field.



Press **DEL** to delete a wiring at the cursor or arrow position. Where connections intersect, the vertical connections are deleted first, then, if you press **DEL** again, the horizontal connections are deleted.

- ▶ Press the cursor button **>** again.

The cursor will move to the coil field.

- ▶ Press **OK**.

“easy” will insert relay coil Q1. The specified coil function “I” and the output relay Q1 are correct and do not have to be changed.

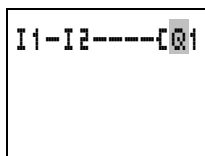

Your first working “easy” circuit diagram now looks like this:

```
I1-I2----Q1
```

Press **ESC** to leave the circuit diagram display. The diagram will be automatically saved.

Once you have connected buttons S1 and S2, you can test your circuit diagram straight away.

Testing the circuit diagram

- ▶ Switch to the main menu and select the RUN menu option.

```
PROGRAM...
RUN
PARAMETER
SET CLOCK..
```

Toggle between RUN and STOP to set the operating mode required, Run or Stop.

“easy” is in Run mode if the STOP menu option is displayed.



Menu options that toggle between two functions always show the next possible setting.

The Status display shows the current mode and the switching states of the inputs and outputs.

- ▶ Change to the Status display and press push-button actuator S1.

EASY412:

```
I12345678
■■■■■■■■ MO
■000 12:50
Q1234 RUN
```

EASY600:

```
12.....
MO 02:00
1.....RUN
```

The contacts (boxes) for inputs I1 and I2 are activated and relay Q1 picks up.

Power flow display

“easy” allows you to check circuit connections in Run mode. This means that you can check your circuit diagram via the built-in power flow display while it is being processed by “easy”.

- ▶ Change to the Circuit diagram display and press push-button actuator S1.

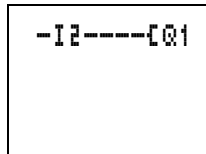

The relay picks up and “easy” shows the flow of current.

- ▶ Press push-button actuator S2, that has been connected as a break contact.

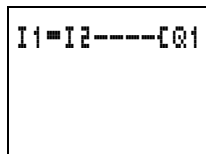

The circuit connection is interrupted and relay Q1 drops out.

Press **ESC** to return to the Status display.



A circuit diagram does not have to be completed before you can test parts of it with “easy”. “easy” simply ignores any incomplete wiring that is not yet working and only uses the finished wiring.

Deleting the circuit diagram

- ▶ Switch “easy” to Stop mode.

The RUN option is displayed.



“easy” must be in Stop mode in order to extend, delete or modify the circuit diagram.

- ▶ Use “PROGRAM...” to switch from the main menu to the next menu level.
- ▶ Select “DELETE PROG”
“easy” will display the prompt “DELETE?”.
- ▶ Press **OK** to delete the program or **ESC** to cancel.



Press **ESC** to return to the Status display.

Fast circuit diagram entry

You can create a circuit diagram in several ways. The first option is to enter the elements in the circuit diagram and then wire all the elements together. The other option is to use the enhanced operator guidance of “easy” and create the circuit diagram in one go, from the first contact through to the last coil.

If you use the first option, you will have to select some of the elements in order to create and connect up your circuit diagram.

The second, faster option is what you learned in the example. In this case you create the entire circuit connection from left to right.

5 Drawing a Circuit Diagram with “easy”

By working through the example in chapter 4 you should now have gained an initial impression of just how simple it is to create a circuit diagram in “easy”. This chapter describes the full range of “easy” functions and provides further examples of how to use “easy”.

Operation of “easy”

Buttons for drawing circuit diagrams



Delete circuit connection, contact, relay or empty line in the circuit diagram



Toggle between break and make contact
Connect contacts and relays
Add circuit connections



^ v Change value
Move cursor up and down
< > Change position
Move cursor to left and right

Cursor buttons set as P buttons:

< Input P1, ^ Input P2
> Input P3, v Input P4



Undo settings from previous **OK**
Exit current display



Change, add contact/relay
Save setting

Operation of “easy”

The cursor buttons in the “easy” circuit diagram perform three functions. The current mode is indicated by the appearance of the flashing cursor.

Move

Enter

Connect

In Move mode you can use $\wedge \vee < >$ to move the cursor around the circuit diagram in order to select a circuit connection, contact or relay coil. 

Use **OK** to switch to Enter mode so that you can enter or change a value at the current cursor position. If you press **ESC** in Enter mode, “easy” will undo the most recent changes. 

Press **ALT** to switch to Connect mode for wiring contacts and relays. Press **ALT** again to return to Move. 

Press **ESC** to leave the circuit diagram and parameter display.



“easy” performs many of these cursor movements automatically. For example, “easy” switches the cursor to Move mode if no further entries or connections are possible at the selected cursor position.

Opening the parameter display

If you specify the contact of a relay type in Enter mode, “easy” automatically switches from the contact number to the parameter display when you press **OK**.

Press $>$ to switch to the next contact or coil field without entering any parameters.

Contacts

Contacts are used to modify the flow of current in the “easy” circuit diagram. Contacts such as make contacts carry a 1 signal when closed and 0 when open. Every contact in the “easy” circuit diagram can be defined as either a make contact or a break contact.

Contact	“easy” representation
Make contact \ Open in the rest state	I, Q, M, A, B, C, T, P, D, S, :, R
/ Break contact L Closed in the rest state	\bar{I} , \bar{Q} , \bar{M} , \bar{A} , \bar{B} , \bar{C} , \bar{T} , \bar{P} , \bar{D} , \bar{S} , \bar{R}

“easy” works with different contacts, which can be used in any order in the contact fields of the circuit diagram.

Contact type	Make	Break	EASY412	EASY600	Page
“easy” input terminal	I	\bar{I}	I1...I8	I1...I12	65
0 signal				I13	
Expansion status			I14	191	
Short circuit/overload			I16	I15...I16	187
P button contact (cursor buttons)	P	\bar{P}	P1...P4	P1...P4	70
“easy” output	Q	\bar{Q}	Q1...Q4	Q1...Q8	65
Marker relay contact	M	\bar{M}	M1...M16	M1...M16	73
Counter relay contact	C	\bar{C}	C1...C8	C1...C8	90
Timing relay contact	T	\bar{T}	T1...T8	T1...T8	84
Time switch contact	B	\bar{B}	B1...B4	B1...B4	93
Analog comparator relay	A	\bar{A}	A1...A8	A1...A8	98
Text marker relay	D	\bar{D}	–	D1...D8	103
“easy” output (expansion or S auxiliary marker)	S	\bar{S}	–	S1...S8	73
Jump label	:	–	–	:1...:8	105
Expansion input terminal	R	\bar{R}	–	R1...R12	65
Short circuit/overload with expansion	R	\bar{R}	–	R15...R16	187

Relays

“easy” has nine different types of relay for wiring in a circuit diagram.

Relay type	“easy” symbol	EASY412	EASY600	Coil function	Parameters
“easy” output relay contact	Q	Q1...Q4	EASY618/619: Q1...Q6 EASY620/621: Q1...Q8	X	–
Marker relay contact	M	M1...M16	M1...M16	X	–
Timing relay contact	T	T1...T8	T1...T8	X	X
Counter relay contact	C	C1...C8	C1...C8	X	X
Time switch contact	Ø	Ø1...Ø4	Ø1...Ø4	–	X
Analog comparator relay	A	A1...A8	A1...A8	–	X
Text marker relay	D	–	D1...D8	X	X
“easy” output relay expansion, S auxiliary marker	S	–	S1...S8	X	–
Conditional jump	:	–	:1...:8	X	–

The switching behaviour of these relays is set by the coil functions and parameters selected.

The options for setting output and marker relays are listed with the description of each coil function.

The coil functions and parameters are listed with the description of each function relay type.

Circuit diagram display

In the “easy” circuit diagram, contacts and coils are connected up from left to right - from the contact to the coil. The circuit diagram is created on a hidden wiring grid containing contact fields, coil fields and circuit connections. It is then wired up with connections.

Insert relay contacts in the three **contact fields**. The first contact field is automatically connected to the voltage.

Insert the relay coil to be controlled together with its function and designation in the **coil field**.

Every line in the circuit diagram forms a **circuit connection**. EASY412 and EASY600 permit the connection of 41 and 121 circuit connections/ current paths respectively.

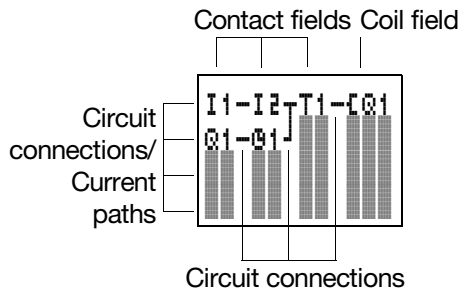

Circuit connections are used to produce the electrical contact between relay contacts and the coils. They can be created across several circuit connections. Each point of intersection is a connection.



The circuit diagram display performs two functions:

In Stop mode it is used to edit the circuit diagram

In Run mode it is used to check the circuit diagram using the Power flow display

Saving and loading circuit diagrams

There are two ways of saving circuit diagrams in “easy” externally:

By saving to a memory card

By saving to a PC running EASY-SOFT.

Once they have been saved, programs can be reloaded into “easy”, edited and run.

All circuit diagram data is saved in “easy”. In the event of a power failure the data will be retained until the next time it is overwritten or deleted.

Memory card

Each memory card contains a circuit diagram which is inserted into the “easy” interface.

The way the memory card works and a description of how to transfer a program to the card is given in chapter 6, from page 126.

EASY-SOFT

EASY-SOFT is an optional PC program with which you can create, store, test (simulate) and manage “easy” circuit diagrams.

Completed circuit diagrams are transferred between your PC and “easy” via the connecting cable. Once you have transferred a circuit diagram, simply run “easy” straight from your PC.

Details on the program and transferring circuit diagrams are given in chapter 6, from page 125.

Working with contacts and relays

In “easy” circuit diagrams, the switches, buttons and relays of conventional circuit diagrams are connected up using input contacts and relay coils.

Conventional circuit

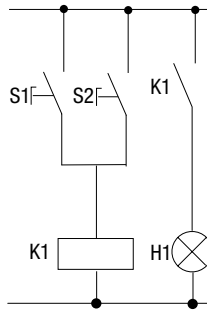

"easy" circuit diagram

Connecting up "easy"

- Connect S1 to "easy" input terminal I1
- Connect S2 to "easy" input terminal I3
- Connect load H1 to "easy" output Q4

S1 or S2 switches on H1.
"easy" circuit diagram



First specify which input and output terminals you wish to use in your circuit.

Depending on the model concerned "easy" has 8 or 12 input terminals and 4, 6 or 8 outputs. The signal states at the input terminals are recorded in the circuit diagram using input contacts I1 to I12 or R1 to R12. In the circuit diagram, the outputs are switched using output relays Q1 to Q8 and S1 to S8.

Entering and changing contacts and relay coils

Define a contact in "easy" via **I 2** its name and number.



A relay coil is defined by its coil **Q 4** function, name and number.

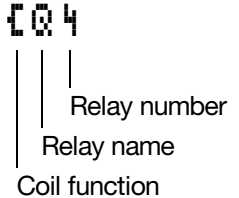

Drawing a Circuit Diagram with “easy”



A full list of all the contacts and relays is given in the overview starting on page 61.

Enter mode is used to modify the value of contact fields and coil fields. The value to be modified value flashes. **I 1**



If the field or section is empty, “easy” will enter contact **I 1** or the coil **CO1**.

- ▶ Move the cursor using the buttons < > ^ v to a contact or coil field.
- ▶ Press **OK** to switch to Enter mode.
- ▶ Use < > to select the position you wish to change, or press **OK** to jump to the next position.
- ▶ Use ^ v to modify the value of the position.

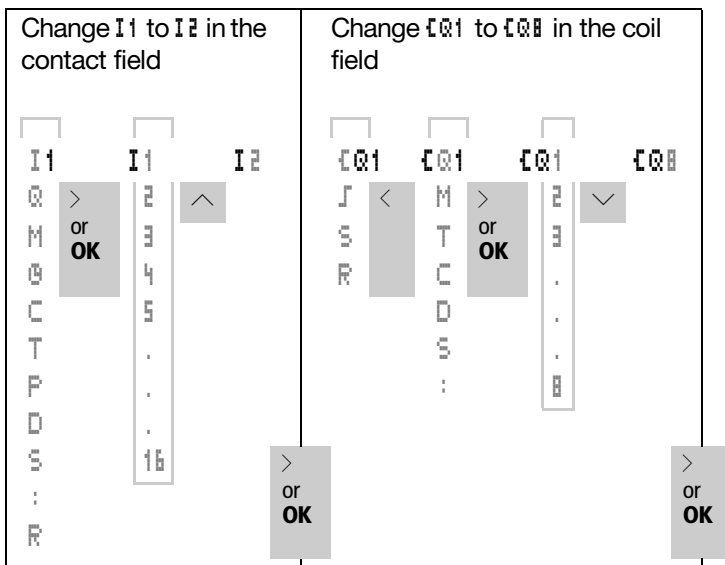

“easy” will leave Enter mode when you press < > or **OK** to leave a contact field or coil field.

Delete all the contacts and relay coils from the circuit connection

- ▶ Move the cursor using the buttons < > ^ ∨ to a contact or coil field.
- ▶ Press **DEL**.

The contact or the relay coil will be deleted, together with any connections.

Changing make contacts into break contacts

Every relay contact in the “easy” circuit diagram can be defined as either a make contact or a break contact.

- ▶ Switch to Enter mode and move the cursor over the contact name.
- ▶ Press **ALT**. The make contact will change to a break contact.
- ▶ Press 2 × **OK** to confirm the change.

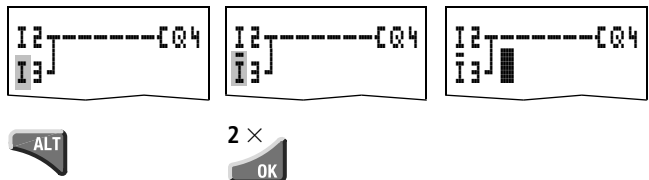

Creating and modifying connections

Contacts and relay coils are connected in Connect mode using the diagonal wiring arrow which is made available in this mode.

- ▶ Use < > ^ ∨ to move the cursor onto the contact field or coil field from which you wish to create a connection.



Do not position the cursor on the first contact field. At this position the **ALT** button has a different function (Insert circuit connection).

- ▶ Press **ALT** to switch to Connect mode.
- ▶ Use < > to move the diagonal arrow between the contact fields and coil fields and ^ v to move between circuit connections.
- ▶ Press **ALT** to leave Connect mode.

“easy” will leave Connect mode automatically when you move the diagonal arrow onto a contact field or coil field which has already been assigned.



In a circuit connection, “easy” automatically connects relay contacts and the terminal to the relay coil if there are no empty fields in-between.

Never work backwards. You will learn why wiring backwards does not work in chapter 9 on page 177.

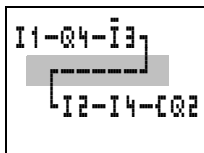

When wiring more than three contacts in series, use one of 16 marker relays M.

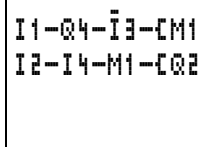

Deleting connections

- ▶ Move the cursor onto the contact field or coil field to the right of the connection that you want to delete. Press **ALT** to switch to Connect mode.
- ▶ Press **DEL**.

“easy” will delete a connection. Closed connections that are lying adjacent will be retained.

If several circuit connections are connected to one another, “easy” first deletes the vertical connection. If you press **DEL** again, it will delete the horizontal connection as well.



You cannot delete connections that “easy” has created automatically.

Close the delete operation with **ALT** or by moving the cursor to a contact or coil field.

Inserting and deleting a circuit connection

The “easy” circuit diagram shows four of the 41 or 121 circuit connections in the display at the same time. “easy” automatically scrolls up or down the display to show hidden circuit connections – even empty ones – if you move the cursor past the top or bottom of the display.

A new circuit connection is added below the last connection or inserted above the cursor position:

- ▶ Position the cursor on the **first** contact field of the empty circuit connection.
- ▶ Press **ALT**.

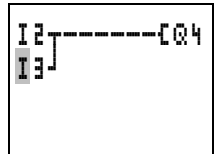

The existing circuit connection with all its additional connections, will be “shifted” down. The cursor will then be positioned directly in the new circuit connection.

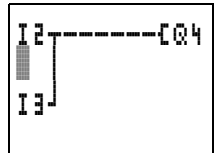

Delete circuit connection

“easy” will only remove empty circuit connections, i.e. those without contacts or coils.

- ▶ Delete all the contacts and relay coils from the circuit connection.
- ▶ Position the cursor on the first contact field of the empty circuit connection.
- ▶ Press **DEL**.

The subsequent circuit connection(s) will be “pulled up” and any existing links between circuit connections will be retained.

Switching via the cursor buttons

With “easy”, you can also use the four cursor buttons as hard-wired inputs in the circuit diagram.

The buttons are shown in the circuit diagram as contacts P1 to P4. The P buttons can be activated and deactivated in the System menu.

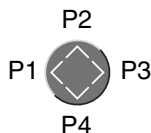

The P buttons can also be used for testing circuits or manual operation. These button functions are also useful for servicing and commissioning purposes.

Example 1

A lamp at output relay Q1 is switched on and off via inputs I1 and I2 or using cursor buttons ^ and v.

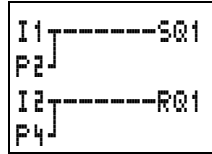

Example 2

Terminal I1 is used to control output relay Q1. Terminal I5 switches to Cursor button mode and deactivates circuit connection I1 via M1.

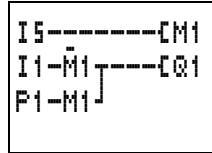

The P buttons are only recognised as contacts in the Status menu, and not in the Power flow display.

The Status menu display shows whether the P buttons are used in the circuit diagram.

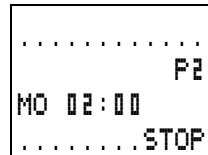
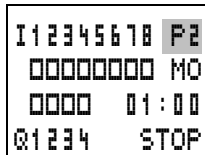

- P Button function wired and active
- P2 Button function wired, active and P2 button ^ pressed
- P- Button function wired, not active
- Empty box: P buttons not used

Checking the circuit diagram

“easy” contains a built-in measuring device enabling you to monitor the switching states of contacts and relay coils during operation.

- ▶ Complete the small parallel connection and switch “easy” to Run mode via the main menu.
- ▶ Return to the circuit diagram display.

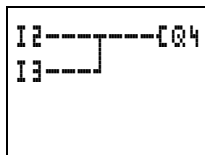

You are now unable to edit the circuit diagram.



If you switch to the circuit diagram display and are unable to modify a circuit diagram, first check whether “easy” is in Stop mode.

The circuit diagram display performs two functions depending on the mode:

STOP: Creation of the circuit diagram

RUN: Power flow display

- ▶ Switch on I3.

In the power flow display, energized connections are thicker than non-energized connections.











You can follow a current-carrying connection across all circuit connections by scrolling the display up and down.

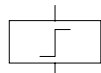

The power flow display will not show signal fluctuations in the millisecond range. This is due to the inherent delay factor of LCD displays.

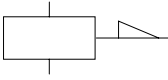
Coil functions

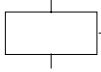
You can set the coil function to determine the switching behaviour of relay coils. The following coil functions are available for relays Q, M, S, D, “:”

Circuit diagram symbol	“easy” symbol	Coil function	Example
		Contactor function	CQ1, CD2, CS4, C:1 CM1
		Impulse relay function	JQ3, JM4, JDB, JS1
		Set (latching)	SQ8, SM2, SD3, SS4
		Reset (unlatching)	RQ4, RM5, RD1, RS3

Marker relay M is used as a “flag”. The S relay can be used as the output of an expansion unit or as a marker if no expansion unit is connected. The only difference between them and the output relay Q is that they have no output terminals.



The functions of timer and counter relays are explained in the relevant relay description.



The coil function  (contactor) should only be used once for each coil. Otherwise the last coil in the circuit diagram will determine the status of the relay.

To ensure a clear overview of all relay states only assign the same coil function once to a relay (J, S, R). However, retentive coil functions such as J, S, R can be used several times if required by the circuit diagram logic.

Exception: The coil function can be used properly several times when using jumps to structure the circuit diagram.

Rules for wiring relay coils

Use the contactor or “impulse relay” function once only for each relay coil.

Only use the “latch” (S) and “unlatch” (R) functions once to control each relay in order to ensure greater clarity in the circuit diagram.

Relays with contactor function



The output signal follows immediately after the input signal and the relay acts as a contactor.

Signal diagram:

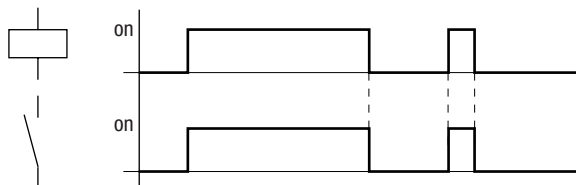

Representation in “easy”

Output relay Q:	<code>{Q1...{Q8}</code> (depending on type)
Marker relay M:	<code>{M1...{M16}</code>
Text display relay D:	<code>{D1...{D8}</code> (EASY600)
Relay S:	<code>{S1...{S8}</code> (EASY600)
Jumps:	<code>{:1...{:8}</code> (EASY600)

Impulse relay



The relay coil switches whenever the input signal changes from 0 to 1. The relay behaves like an impulse relay.

Signal diagram:

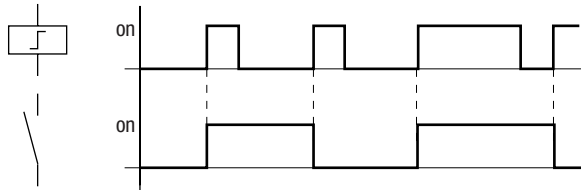

Representation in “easy”

- Output relay Q: `[Q1 ...Q8]`
(depending on type)
- Marker relay M: `[M1 ...M16]`
- Text display relay D: `[D1 ...D8]` (EASY600)
- Relay S: `[S1 ...S8]` (EASY600)



A coil is automatically switched off if the power fails and if “easy” is in Stop mode. Exception: Retentive coils retain signal 1 (see chapter 8, page 151).

Latching relay

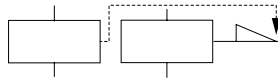

The “latch” and “unlatch” relay functions are used in pairs. The relay picks up when latched and remains in this state until it is reset by the “unlatch” function.

Signal diagram:

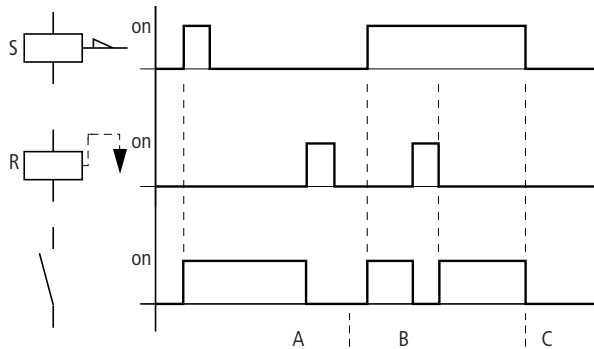

C = Supply voltage switched off

Representation in “easy”

Output relay Q:	$SQ1 \dots SQ8, RQ1 \dots RQ8$ (depending on type)
Marker relay M:	$SM1 \dots SM16, RM1 \dots RM16$
Function relay (Text) D:	$SD1 \dots SD8, RD1 \dots RD8$ (EASY600)
Relay S:	$SS1 \dots SS8, RS1 \dots RS8$ (EASY600)

Use each of the two relay functions S and R once only per relay.

If both coils are triggered at the same time, priority is given to the coil further down in the circuit diagram. This is shown in the above signal diagram in section B.

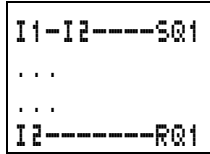

A latched relay is automatically switched off if the power fails or if the device is in Stop mode. Exception: Retentive coils retain signal 1 (see chapter 8, page 151).

Function relay

The function relays are used to simulate some of the devices used in conventional control systems. “easy” provides the following function relay types:

Circuit diagram symbol	Function relays
	Timing relay, on-delayed Timing relay, on-delayed with random switching
	Timing relay, off-delayed Timing relay, off-delayed with random switching
	Timing relay, single pulse Timing relay, flashing
	Counter relay, up/down counter
	Time switch, weekday/time (only in “easy” models with clock)
	Analog comparator relay (only in “easy” 24 V DC models)
	Text (only EASY600)

Drawing a Circuit Diagram with “easy”

A function relay is started via its relay coil or by evaluating a parameter. It switches the contact of the function relay according to its function and the set parameters.



Current actual values are cleared if the power supply is switched off or if “easy” is switched to Stop mode.

Exception: Retentive coils retain their state (see chapter 8, page 151).

In timing and counter relays, it is also possible to change the switching behaviour via the coil functions.

Example with timing and counter relays

A warning light flashes when the counter reaches 10. The following example shows function relays C1 and T1.

Hard-wiring with relays

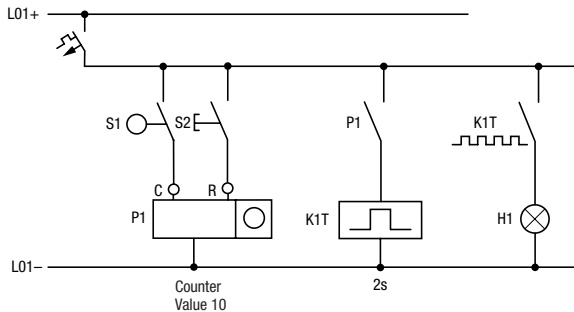

“easy” wiring
and circuit diagram

I5	-----	CC1
I6	-----	RC1
C1	-----	TT1
T1	-----	Q1

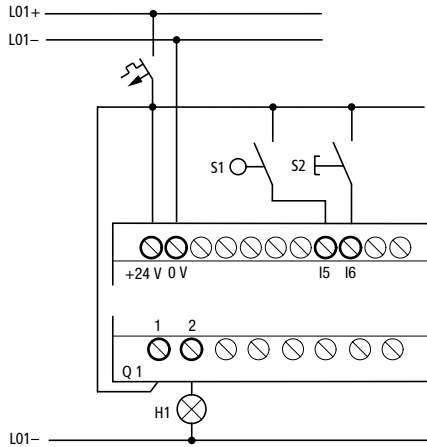

You can use the circuit diagram form at the back of this manual for planning and preparing your “easy” circuit diagrams.

On the next two pages you will learn how to enter the example on the form.

Drawing a Circuit Diagram with "easy"

"easy" Control Relay Circuit Diagram

FO 98

Customer: J. Smith Ltd.

Program: Warning light

Date: 17.04.98

Page: 1

Comment:

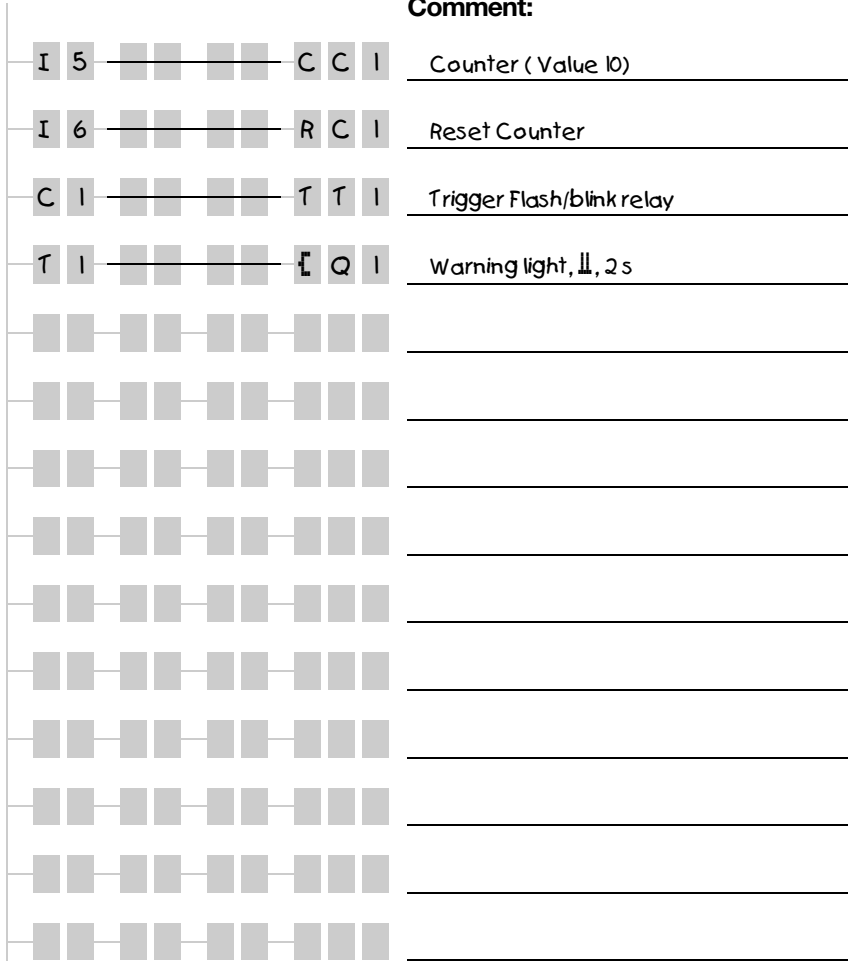

“easy” Control Relay Circuit Diagram

FO 98

Customer: J. Smith Ltd. Program: Warning light
 Date: 17.04.98 Page: 2

Timing relays

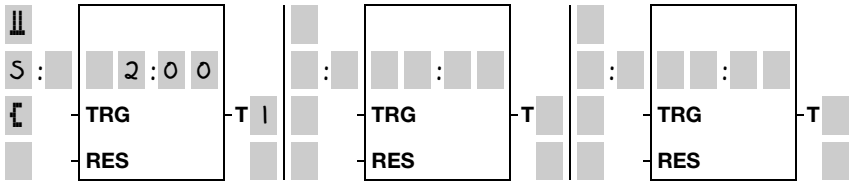

Analog comparators

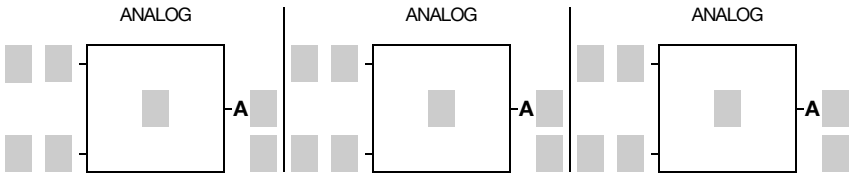

Timing switches

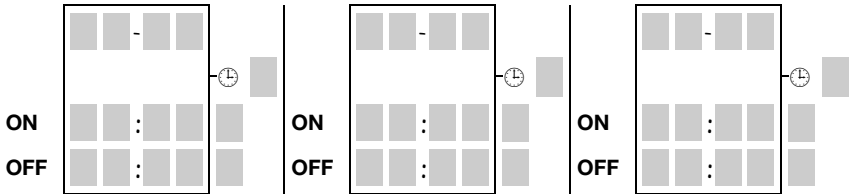

Up/down counters

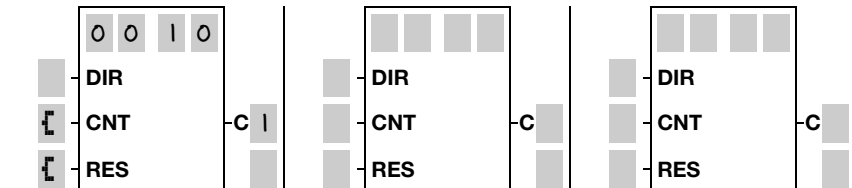

Drawing a Circuit Diagram with “easy”

- ▶ Enter the circuit diagram up to “C1” in the third circuit connection.

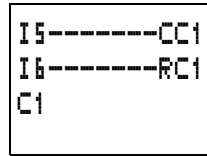

C1 is the contact of counter relay 1.



If the cursor is on the contact number, “easy” will call up the parameter display when you press **OK**.

- ▶ Move the cursor onto the 1 in C1 and press **OK**.

The parameter set for the counter is displayed.

- ▶ Change the counter setpoint to 10:

Use < > to move the cursor onto the tens digit.

Use ^ v to modify the value of the digit.

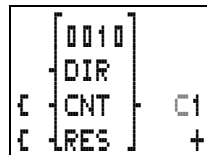

Press **OK** to save the value and **ESC** to return to the circuit diagram.



“easy” has specific parameter displays for function relays. The meaning of these parameters is explained under each relay type.

- ▶ Enter the circuit diagram up to contact T1 of the timing relay. Set the parameters for T1.

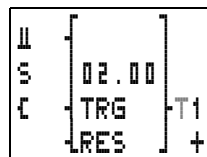

The timing relay works like a flasher/blink relay. The “easy” symbol for the flasher/blink relay is “**⏏**”. It is set at the top left of the parameter display.

- ▶ Complete the circuit diagram.
- ▶ Test the circuit diagram using the power flow display.
- ▶ Switch “easy” to Run mode and return to the circuit diagram.

Each parameter set can be displayed using the power flow display for the circuit diagram.

- Move the cursor onto C1 and press **OK**.

The parameter set for the counter is displayed with actual and setpoint values.

[0010] 0000
-	DIR	
[CNT] C1
[RES] +

- Switch I5. The actual value changes.

The coil terminal CNT is activated for as long as you press push-button actuator S1. This is represented in the “easy” parameter display.

[0010] 0002
-	DIR	
[CNT] C1
[RES] +

If the actual and setpoint values are the same, the timing relay switches the warning light on and off every 2 seconds.

Doubling the flashing frequency:

- Select T1 in the power flow display and change the setpoint time to 01.00.

U	[01.23]
S		01.00	
[TRG] T1	
[RES] +	

When you press **OK**, the warning light will flash at twice the frequency.

You can also modify parameter settings via the **PARAMETER** menu option.



If you want to prevent other people from modifying the parameters, change the access enable symbol from “+” to “-” when creating the circuit diagram and setting parameters and protect the circuit diagram with a password.

Timing relays

“easy” provides eight different timing relays T1 to T8 for use as required.

A timing relay is used to change the switching duration and the make and break times of a relay contact. The possible delay times range between 10 ms and 100 h.

Wiring a timing relay

A timing relay is integrated into your circuit in the form of a contact. The function of the relay is defined via the parameter display. The relay is started via the trigger input TRG and can be reset via the reset input RES.



To prevent unpredictable switching states, use each coil of a relay once only in the circuit diagram.

- ▶ At least two elements are needed in the circuit diagram for a timing relay:

A relay contact in the contact field, in this case T2

A trigger coil in the coil field, in this case TT2.

You can also wire up the reset coil RT2 if you wish.

- ▶ Enter the number of the relay contact T2 and press **OK**.

Task:

Switch on output Q1
1.5 min. after actuation
via I1,
Switch off T2 via I2.

Circuit diagram:

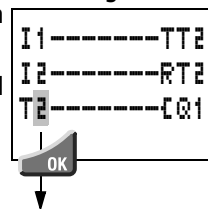

The parameter set for timing relay T2 is displayed.

- ▶ Specify the function of the relay.

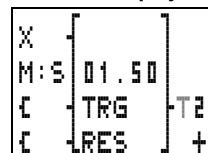

Parameter set for times

The parameter display for a timing relay is used to modify the switching function, setpoint time and time range and to enable or disable parameter access.

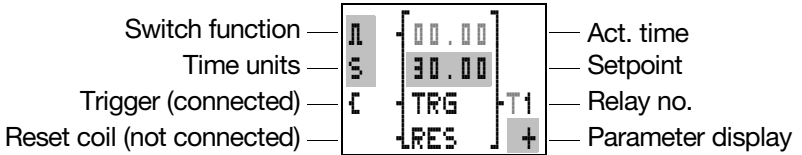

A contactor symbol “λ” in front of TRG or RES indicates whether the relay function is wired in the circuit diagram. The coil terminals are not shown if you access the parameters via the PARAMETER menu option.



The actual time is only displayed in Run mode. To view the actual time, call up the parameter display via the power flow display or using the PARAMETER option.

Switch function parameters

- λ X Switch with on-delay
- λ X Switch with on-delay and random time range
- Switch with off-delay
- λ ■ Switch with off-delay and random time range
- λ Switch with single-pulse
- λ Switch with flashing



Minimum time setting with
EASY412: 40 ms
EASY600: 80 ms

A time value less than the maximum “easy” cycle time may cause uncontrolled switching states.

Time range and setpoint time parameters	Resolution
S: <input type="text"/> : <input type="text"/> : <input type="text"/> Seconds: 10×millisec., 00.00 ... 99.99	10 ms
M: S: <input type="text"/> : <input type="text"/> : <input type="text"/> Minutes: Seconds, 00:00 ... 99:59	1 s
H: M: <input type="text"/> : <input type="text"/> : <input type="text"/> Hours: Minutes, 00:00 ... 99:59	1 min.

Parameter set displayed via the PARAMETER menu option

+ Access enabled	- Access disabled
------------------	-------------------

Timing relays, on-delayed, without and with random switching

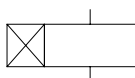

The relay switches a contact after the setpoint delay has elapsed.



With random switching, the relay contact switches randomly at any time up to the specified time value (shown shaded in figure).

Signal diagram:

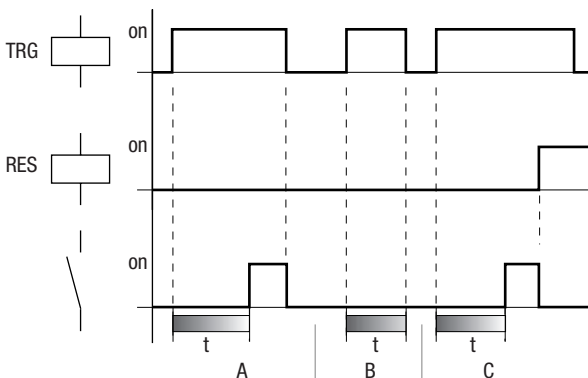

The trigger input starts the time (t). If the trigger input disconnects after the time has elapsed, the contact is reset (A). If the trigger coil drops out before the time has elapsed, the contact is not switched (B). The reset coil has priority over the trigger coil and always

resets the relay contact (C). If the time is set to zero, the contact follows immediately after the trigger signal.

Typical applications

- Switching conveyor belts on or off after a delay
- Detecting gaps in the switching of sensors in the event of a fault
- Automatic window shutter control with random switching times

Timing relays, off-delayed with and without random switching

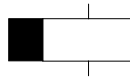

The relay switches a contact immediately and then resets it after the setpoint delay has elapsed.



With random switching, the relay contact switches randomly at any time up to the specified time value (shown shaded in figure).

Signal diagram:

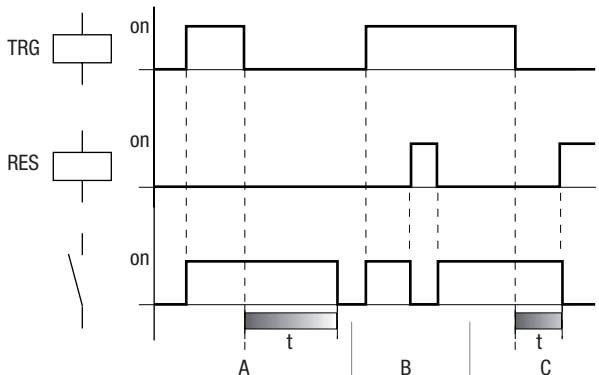

The trigger coil switches the contact. If the trigger coil (A) drops out, the setpoint time starts and resets the contact after the time has elapsed. The reset coil has priority over the trigger coil and always resets the

relay contact (B, C). If the time is set to zero, the contact follows immediately after the trigger signal.

Typical applications

Activating the deceleration of motors or fans

Automatic lighting control for vacant buildings
with random switching times

Timing relays, single pulse



⏏

The relay switches a contact for a time equal to the delay time set, regardless of the length of the trigger signal.

Signal diagram:

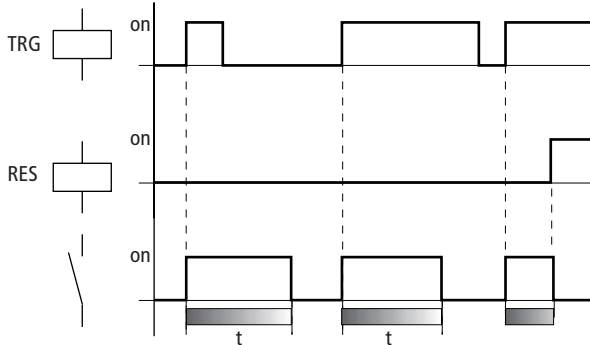

The reset coil has priority over the trigger coil and resets the relay contact before the time has elapsed. If the time is set to zero, the contact is set for the duration of one cycle.

The cycle time varies according to the length of the circuit diagram.

Typical applications

Adjusting switching signals to a defined pulse length

Shortening pulses to the duration of a cycle

Timing relays, flashing



The relay closes and opens the relay contact alternately at the set flashing frequency.

||

$$\text{Flash frequency} = \frac{1}{2 \times \text{set time}}$$

Example

Set time: 0.2 s, Flash frequency = $\frac{1}{0.4 \text{ s}} = 2.5 \text{ Hz}$

Signal diagram:

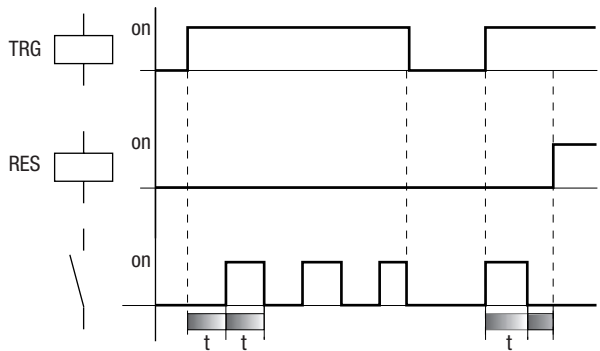

The trigger coil switches the flashing on and off. The flashing period starts with switch position “off”. The reset coil has priority over the trigger coil and always resets the relay contact.

If the time is set to zero, the flash frequency changes with the cycle time. The cycle time varies according to the length of the circuit diagram.

Typical applications

Activating warning lamps

Counter relays

“easy” works with counter relays C1 to C8.

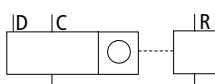

The counter relay increments or decrements signals and switches when the actual value is greater than or equal to the setpoint value. Values between 0000 and 9999 are possible.

A counter relay can be controlled via the counting pulse CCx, counting direction DCx and reset RCx relay functions.

Signal diagram:

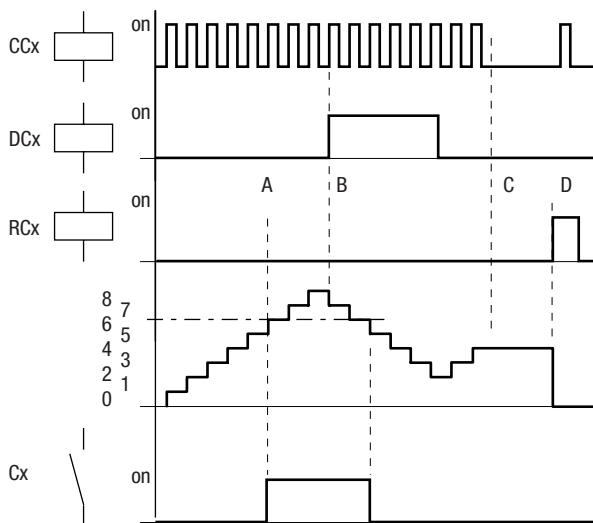

The relay contact of a counter with setpoint value 6 switches when the actual value is 6 (A). If the counting direction is reversed (B), the contact switches back when the actual value is 5. Without a counting pulse, the current actual value is retained (C). The reset coil resets the counter to 0 (D).

Possible applications include the counting of components, lengths or event frequency.

Wiring a counter relay

You integrate a counter relay into your circuit in the form of a contact and coil. Counter relay C1 receives counting pulses via the count coil CC1. The counting direction can be changed via the direction coil DC1:

DC1 = 0: relay C1 counts up

DC1 = 1: relay C1 counts down

The Reset coil RC1 is used to reset the counter to the actual value 0.

Contact C1 is used to process the result of the counter in the circuit diagram.



To prevent unpredictable switching states, use each coil of a relay once only in the circuit diagram.

- ▶ Enter at least one contact and a coil in your circuit diagram: A relay contact in the contact field, in this case C1
- ▶ Enter at least one contact and a coil in your circuit diagram: A count coil in the coil field, in this case CC1.

Task: Switch output Q1 after the 5th part in one direction.
 I1 counter pulse
 I2 resets actual value
 I3 determines direction

You can wire up coils RC1 and DC1 as required.

- ▶ Select relay contact C1, move the cursor to 1 and press **OK**.

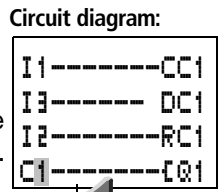

The parameter set for counter relay C1 is displayed.

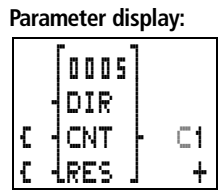

Determining counter frequency

The maximum counter frequency depends on the length of the circuit diagram in “easy”. The number of contacts, coils and circuit connections used determines the run time (cycle time) required to process the “easy” circuit diagram.

Example: When using EASY412-DC-TC with only three circuit connections for counting, resetting and outputting the result via the output, the counter frequency may be 100 Hz.

To determine the cycle time refer to chapter 9 on page 175.

The maximum counter frequency depends on the maximum cycle time.

Use the following formula to determine the maximum counter frequency:

$$f_c = \frac{1}{2 \times t_c} \times 0.8$$

f_c = maximum counter frequency

t_c = maximum cycle time

0.8 = correction factor

Example

The maximum cycle time is $t_c = 4000 \mu\text{s}$ (4 ms).

$$f_c = \frac{1}{2 \times 4 \text{ ms}} \times 0.8 = 100 \text{ Hz}$$

Parameter set for counters

The parameter display for counters is used to change the counter setpoint value and to enable or disable parameter access.

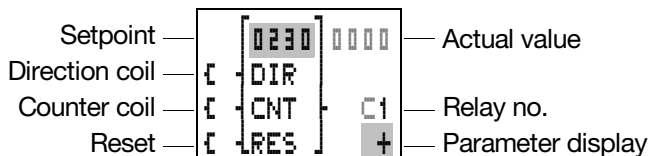

Values between 0000 and 9999 are possible.

Parameter	Coil function	Meaning
DIR	D	Counting direction DCx=0: count up DCx=1: count down
CNT	C	Counting pulse
RES	R	Reset

The contactor symbol “” before DIR, CNT and RES indicates whether the coil function is wired in the circuit diagram.

Parameter set displayed via the PARAMETER menu option

+ Access enabled	- Access disabled
------------------	-------------------





The actual value is only displayed in Run mode. The parameter display can then be called up via the power flow display or via the PARAMETER option from the main menu. The coil symbol is not displayed if you select the parameter display via the PARAMETER menu option.

Time switch

Versions of “easy” with the type suffix “-RC(X)” or “TC(X)” are equipped with a real-time clock which can be used in the circuit diagram as a 7-day time switch.



The procedure for setting the time is described under chapter 7 on page 143.

“easy” has four time switches “1” to “4”, providing a total of 32 switching times.



Each time switch has four channels which you can use to set four on and off times. The channels are set via the parameter display.

The timer has a back-up battery. This means that it will continue to run in the event of a power failure, although the time switch relays will not switch. When the timer is disconnected from the power supply, the contacts remain open. Information on the battery back-up time are provided in chapter 11, page 197.

Example 1

Time switch “01” switches on Monday to Friday between 6:30 and 9:00 and between 17:00 and 22:30.

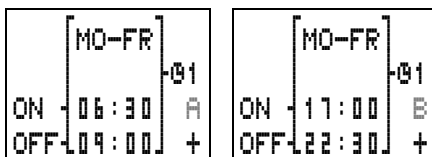

Signal diagram:

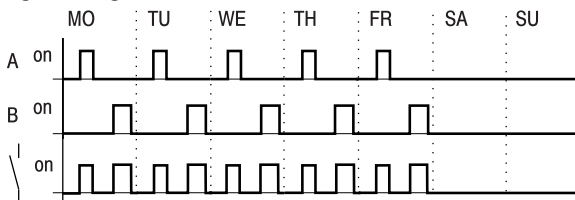

Example 2

Time switch “02” switches at 16:00 on Friday and switches off at 6:00 on Monday.

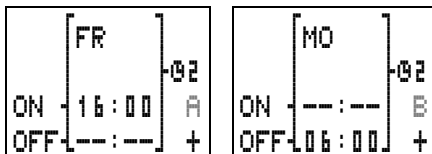

Signal diagram:

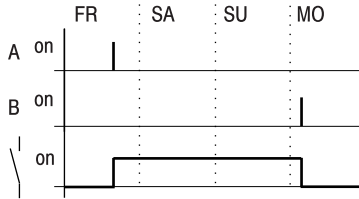

Example 3

Time switch “03” switches on overnight at 22:00 on Monday and switches off at 6:00 on Tuesday.

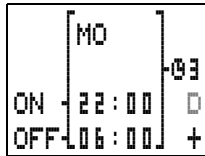

Signal diagram:

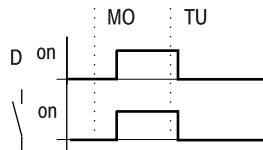

If the Off time is before the On time, “easy” will switch off on the following day.

Example 4

The time settings of a time switch overlap. The clock switches on at 16:00 on Monday, whereas on Tuesday and Wednesday it switches on at 10:00. On Monday to Wednesday the switching-off time is 22:00.

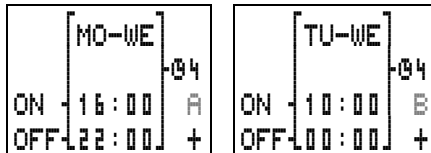

Drawing a Circuit Diagram with “easy”

Signal diagram:

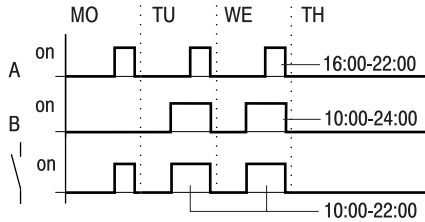

Switch-on and switch-off times always follow the channel which switches first.

Example 5

The power is removed between 15:00 and 17:00. The relay drops out and remains off, even after the power returns, since the first switching-off time was at 16:00.

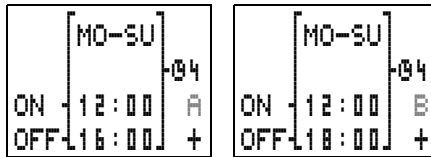

When it is switched on, “easy” always updates the switching state on the basis of all the available switching time settings.

Example 6

The time switch is to switch for 24 hours. Switch-on time at 0:00 on Monday and switch-off time at 0:00 on Tuesday.

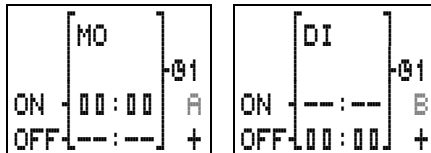

Wiring a time switch

A time switch can be integrated into your circuit in the form of a contact. Use the parameter display to set the switching-on and switching-off times.

- ▶ Enter the relay contact for the **Task:** time switch in the contact field. Switch output Q3 on at 6:00 on Monday to Friday and switch off at 22:30.

The cursor is over the contact number of the time switch.

Circuit diagram:

- ▶ Press **OK** to set the switching times.

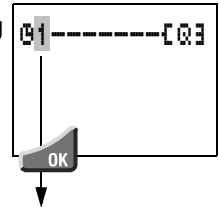

The parameter set for the first channel is displayed.

- ▶ Set the switching times for the **Parameter display:** parameter set.

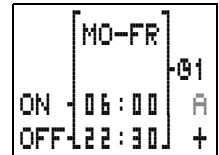

Parameter set for the time switch

A time switch has four sets of parameters, one for each channel (A, B, C and D). These are used to set the day of the week and the switching-on and switching-off times for the desired channels and to enable or disable parameter access.



Changing the switching times is described under chapter 7 from page 142.

You can only change the setting “+”/“-” for displaying the parameters via the PARAMETER menu option when you are editing the circuit

Drawing a Circuit Diagram with “easy”

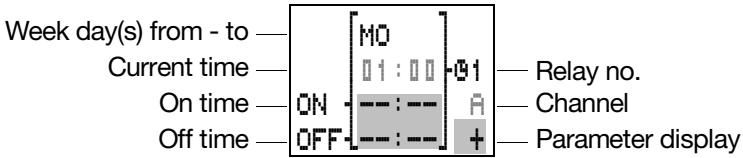

The time only appears in the parameter display in Run mode.

Call up the parameter display in Run mode via the power flow display or via PARAMETER in the main menu.

Switching-on and switching-off times

Parameters	Meaning	Valid setpoint times
Weekday	Monday to Sunday	MO, TU, WE, TH, FR, SA,
On time	Hours: Minutes: No time set at "--:--"	00:00 to 23:59, --:--
Off time	Hours: Minutes: No time set at "--:--"	00:00 to 23:59, --:--

Parameter set displayed via the PARAMETER menu option

+ Access enabled	- Access disabled
------------------	-------------------

Analog comparators

Analog comparators are only available with 24 V “easy”-DC models. They monitor the voltages of sensors that are connected to terminals I7 and I8.

“easy” provides eight analog comparators “A1” to “A8” for use as required.



A comparator can perform six different types of comparison. The relay contact switches if the comparison conditions are fulfilled.

$I7 \geq I8, I7 \leq I8$

$I7 \geq \text{setpoint}, I7 \leq \text{setpoint}$

$I8 \geq \text{setpoint}, I8 \leq \text{setpoint}$

Both the setpoint value and the actual value correspond to the measured voltages.

Resolution of the voltage values:

0.0 to 10.0 V in 0.1 V steps

From 10 V to 24 V the actual value stays at 10.0.

You can enter the setpoint values for a comparison while you are creating the circuit diagram or in the parameter display in Run mode.

Typical applications

Evaluating the analog values of sensors, e.g. in order measure the pressure or temperature.

Two-step controllers

Example:

Analog comparator A1 latches (sets) relay Q1 if the actual value drops below the lower setpoint value of 7.1 V. Comparator A2 unlatches (resets) the relay if it rises above the upper setpoint value of 7.5 V. Thus the difference (switching hysteresis) between the two voltage setpoint values is 0.4 V.

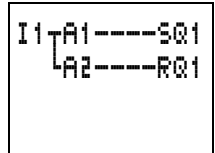

The parameter settings are:

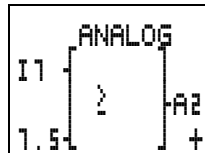
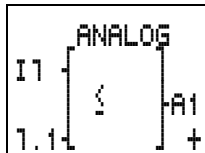

Drawing a Circuit Diagram with “easy”

Signal diagram:

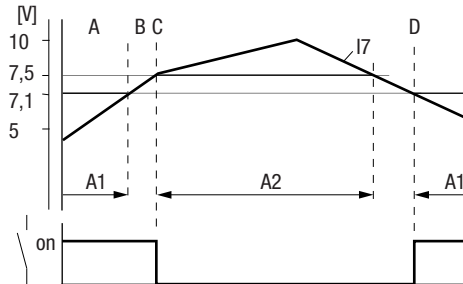

A1 sets relay output Q1 (A) up to a voltage of 7.1 V. The hysteresis (B) is between 7.1 V and 7.5 V. At 7.5 V, A2 causes the relay to reset (C). Q1 drops out and does not pick up again until A1 is set at 7.1 V (D).



Analog signals of sensors typically fluctuate by several millivolts. For stable set and reset switching the setpoints should differ by at least 0.2 V (switching hysteresis).



Caution

To prevent the uncontrolled switching of the relay coils only use the Set and Reset functions with the analog comparators.

Wiring analog comparators

You integrate an analog comparator into your circuit in the form of a contact. Use the parameter display to select one of six possible comparators and enter the setpoint values.

- ▶ Enter the relay contact for the **Task:**
analog comparator in the contact field. Output Q3 should switch on at a certain value.

The cursor is then located on the contact number of the comparator.

Circuit diagram:

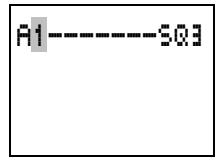

- ▶ Press **OK** to switch to the parameter display.

The parameter set for the first comparator is displayed.

- ▶ Use $\langle \rangle$ to move the cursor to the field \cong . Use $\wedge \vee$ to select one of the comparator relays.

I7 \cong I8

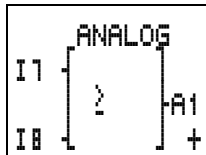

I7 \cong setpoint

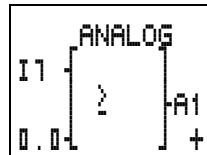

I7 \leq setpoint

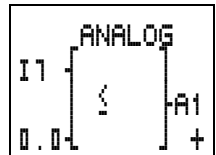

I7 \leq I8

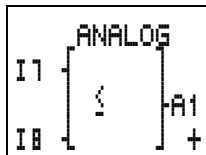

I8 \cong setpoint

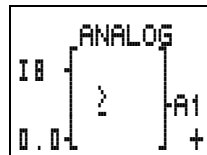

I8 \leq setpoint

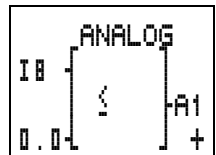

- ▶ Press **OK** to finish or enter another setpoint value. Press **ESC** to return to the circuit diagram display.

Parameter sets for analog comparators

The parameter display for analog comparators can be used to set the comparison “ \geq ” or “ \leq ” and to enable or disable the parameter access.

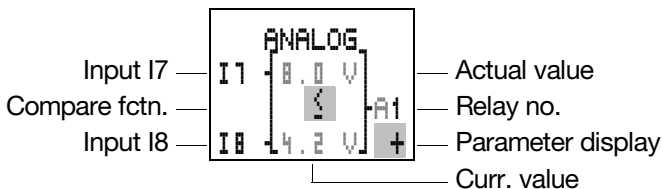

If you want to compare an input with a setpoint value, you must also set the setpoint value.



The actual values are only displayed in Run mode. Call up the parameter display in Run mode via the power flow display or via PARAMETER in the main menu.

You cannot set parameters when comparing two values.

Parameters	Function	Meaning
Compare fctn.	\geq	Greater than or equal to
	\leq	Less than or equal to
Setpoint	□ . □	Setpoint value, 0.0 to 9.9, 10.0 = overflow

Parameter set displayed via the PARAMETER menu option

+ Access enabled	- Access disabled
------------------	-------------------

Text display

EASY600 allows you to display eight user-defined texts which can be edited in EASY-SOFT from V. 2.0 upwards. The texts are saved in the EASY-SOFT file *.eas or on the “easy-M-16K” memory card for EASY600.

Example

THINK
FUTURE
SWITCH TO
GREEN

Circuit diagram symbols for text display

Contacts	Make contact	\square
	Break contact	\square
Numbers		1 to 8
Coils		\square
Numbers		1 to 8
Coil functions		[, S, R, J]

LCD display

Up to 12 characters per line and up to 4 lines can be displayed.

Variables

Actual values and setpoints of timing relays and counters, scaled actual values from analog input I7 or I8, as well as the current time are displayed automatically in lines 2 or 3, characters 5 to 8 (characters 5 to 9 for time display, see 13:51 in example below). If you have entered text at these locations, they will be overwritten by the variable values. Enter a blank space as the placeholder (at 13:51 in the example), in order to continue text after the variable display.

Example: TIME13:51

Scaling

The value ranges of the analog inputs I7, I8 (0 to 10 V) can be displayed in the following way.

Analog value, range	Selectable display range	Example
0 to 10 V	0 to 9999	0000 to 0100
0 to 10 V	± 999	-025 to 050
0 to 10 V	± 9.9	-5.0 to 5.0

Function

The marker relays D = Display function in the circuit diagram as normal M markers. All eight markers can be used retentively.

If a text is assigned to a marker, it will be displayed in the “easy” LCD if the coil is set to 1. For this to happen “easy” must be in Run mode and the Status display must be showing before the text is activated.

The following conditions apply to **D2** to **D8**:

When activating several texts, they will be displayed automatically every 4 s in succession. This process will be repeated until

- none of the display markers are set to 1.
- Stop mode is selected.
- the “easy” power supply is switched off.
- the **OK** or **DEL + ALT** buttons are used to switch to a menu.
- the text for D1 is displayed.

The following applies to **D1**:

D1 is designed as an alarm text.

If D1 is activated, the text assigned to it will be displayed until

- the coil D1 is reset to 0.
- Stop mode is selected.
- the “easy” power supply is switched off.

the **OK** or **DEL + ALT** buttons are used to switch to a menu.

Text entry

Text entry is only possible using EASY-SOFT, from version V 2.0 upwards

Character set

All ASCII characters in upper and lower case are permissible.

A B C D E F G H I J K L M N O P Q R S T
U V W X Y Z

a b c d e f g h i j k l m n o p q r s t u v w x y z

The following special characters are permissible:

! " # \$ % & ' () * + , - . / 0 1 2 3 4 5 6 7 8 9

Examples

Counter with
actual value and setpoint

Analog values scaled as
temperature values

D1 as error message on
fuse failure

```

QUANTITY
QTY.0042
SETP0500 PCE
!COUNTING!
    
```

```

TEMPERATURE
A  -010DEG.
I  +018DEG.
HEATING
    
```

```

FUSE
FAULT
HOUSE 1
FAILED!
    
```

Jumps

Jumps can be used to optimize the structure of a circuit diagram or to implement the function of a selector switch. Jumps can be used for example to select whether manual/automatic operation or other machine programs are to be set.

Jumps consist of a jump location and a jump destination (label).

Circuit diagram symbols for jumps

Contact	Make contact	:
(can only be used as first leftmost contact)		
Numbers		1 to n
Coils		⌈
Numbers		1 to n
Coil function		⌈

Function

If the jump coil is triggered, the circuit connections coming directly after it will not be processed. The states of the coils before the jump will be retained, unless they are overwritten in circuit connections that were not missed by the jump. Jumps are always made forwards, i.e. the jump ends on the first contact with the same number as that of the coil.

Coil = jump when 1

Contact only at the first leftmost contact = Jump destination

The Jump contact point will **always be set to 1**



Backward jumps are not possible with “easy” due to the way it operates. If the jump label does not come after the jump coil, the jump will be made to the end of the circuit diagram. The last circuit connection will also be skipped.

If a jump destination is not specified, the jump will be made to the end of the circuit diagram.

Multiple use of the same jump coil and jump contact is possible as long as this is implemented in pairs, i.e.

Coil ⌈ :1/jumped range/Contact :1,

Coil ⌈ :1/jumped range/Contact :1 etc.



Attention

The states of jumped circuit connections are retained. The time value of timing relays that have been started will continue to run.

Power flow display

Jumped ranges are indicated by the coils in the power flow display.

All coils after the jump coil are shown with the symbol of the jump coil.

Example

A selector switch allows two different sequences to be set.

Sequence 1: Switch on Motor 1 immediately.

Sequence 2: Switch on Guard 2, Wait time, then switch on Motor 1.

Contacts and relays used:

I1	Sequence 1
I2	Sequence 2
I3	Guard 2 moved out
I12	Motor-protective circuit-breaker switched on
Q1	Motor 1
Q2	Guard 2
T1	Wait time 30.00 s, on-delayed
D1	Text "Motor-protective circuit-breaker tripped"

Drawing a Circuit Diagram with “easy”

Circuit diagram:

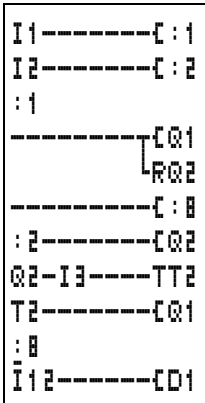

Power flow display: I1 selected:

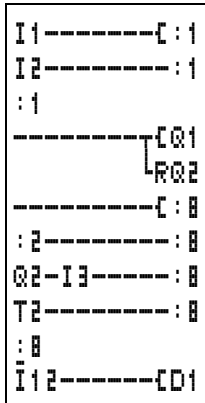

Range from jump label 1 processed.

Jump to label 8.

Range to jump label 8 skipped.

Jump label 8, circuit diagram processed from this point on.

Example circuits

Basic circuits

The “easy” circuit diagram is created using ladder diagrams. This section contains a few circuits intended to demonstrate the possibilities for your own circuit diagrams.

The values in the logic table have the following meanings

for contacts:

0 = make contact open, break contact closed

1 = make contact closed, break contact open

for relay coils Qx:

0 = coil not energized

1 = coil energized

Negation

Negation means that the contact opens, rather than closes, when it is actuated (NOT circuit).

In the “easy” circuit diagram, press the **ALT** button to toggle contact I1 between break and make contact.

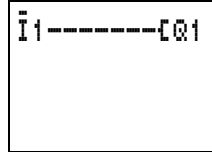

Logic table:

I1	Q1
1	0
0	1

Permanent contact

To energize a relay coil continuously, make a connection of all contact fields from the coil to the leftmost position.

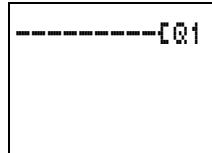

Logic table:

---	Q1
1	1

Series connection

Q1 is controlled by a series circuit consisting of three make contacts (AND circuit).

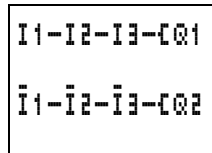

Q2 is controlled by a series circuit consisting of three break contacts (NOR circuit).

In the “easy” circuit diagram, you can connect up to three make or break contacts in series within a circuit connection. Use “M” marker relays if you need to connect more than three make contacts in series.

Logic table:

I1	I2	I3	Q1	Q2
0	0	0	0	1
1	0	0	0	0
0	1	0	0	0
1	1	0	0	0
0	0	1	0	0
1	0	1	0	0
0	1	1	0	0
1	1	1	1	0

Parallel connection

Q1 is controlled by a parallel circuit consisting of three make contacts (OR circuit).

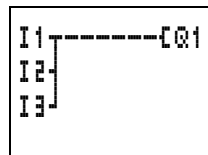

A parallel circuit of break contacts controls Q2 (NAND circuit).



Logic table:

I1	I2	I3	Q1	Q2
0	0	0	0	1
1	0	0	1	1
0	1	0	1	1
1	1	0	1	1
0	0	1	1	1
1	0	1	1	1
0	1	1	1	1
1	1	1	1	0

Changeover circuit

A changeover circuit is made in “easy” using two series connections that are combined to form a parallel connection (XOR).

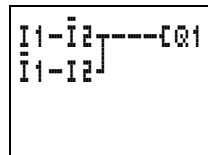

XOR means that this circuit is an “Exclusive OR circuit”. Only if one contact switches, can the coil be energized.

Logic table:

I1	I2	Q1
0	0	0
1	0	1
0	1	1
1	1	0

Latching circuit

A combination of a series and parallel connection is used to wire a latching circuit.

Latching is established by contact Q1 which is parallel to I1. If I1 is actuated and reopened, the current flows via contact Q1 until I2 is actuated.

S1 make contact on I1
S2 break contact on I2

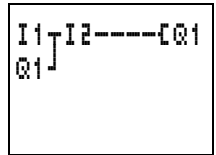

Logic table:

I1	I2	Contact Q1	Coil Q1
0	0	0	0
1	0	0	0
0	1	0	0
1	1	0	1
1	0	1	0
0	1	1	1
1	1	1	1

Latching circuits are used to switch machines on and off. The machine is switched on at the input terminals via make contact S1 and is switched off via break contact S2.

S2 opens the connection to the control voltage in order to switch off the machine. This ensures that the machine can be switched off, even in the event of a wire break. I2 is always closed when not actuated.

A self-latching circuit with wire break monitoring can alternatively be wired using the Set and Reset coil functions.

S1 make contact on I1
S2 break contact on I2

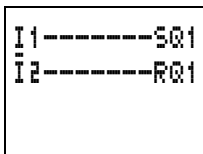

Relay Q1 is latched when I1 is switched on. I2 inverts the break contact signal from S2 and does not switch until S2 is actuated.

In this way, the machine is switched off if or when a wire breaks.

Make sure that both coils are wired up in the correct order in the “easy” circuit diagram: first wire the “S” coil and then the “R” coil. This means that the machine will be switched off when I2 is actuated, even if I1 is switched on.

Impulse relay

An impulse relay is often used for controlling lighting such as for staircase lighting.

S1 make contact on I1

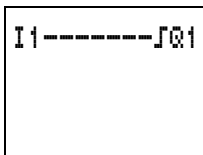

Logic table:

I1	State Q1	Q1
0	0	0
1	0	1
0	1	1
1	1	0

On-delayed timing relay

The on-delay can be used to gate short pulses or to initiate another movement with a time delay when a machine is started.

S1 make contact on I1

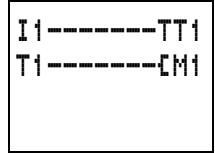

The parameter settings for T1 are:

Timing function on-delayed:
"X"

Time value and range:
10 seconds

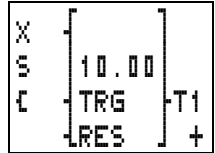

If I1 is switched on, coil T of T1 is energized. After 10 seconds, T1 switches the marker relay M1. If I1 is switched off, relay coils T1 and M1 drop out.

Logic table:

I1	T1	M1
0	0	0
1	0	0
1	1	1

Star-delta starting

You can implement two star-delta circuits with "easy". The advantage of "easy" is that you can select any changeover time between star and delta contactors and any wait time between switching off the star contactor and switching on the delta contactor.

Drawing a Circuit Diagram with “easy”

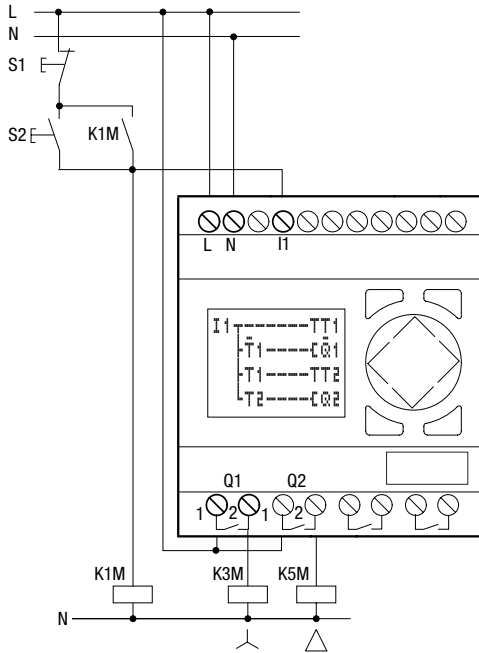
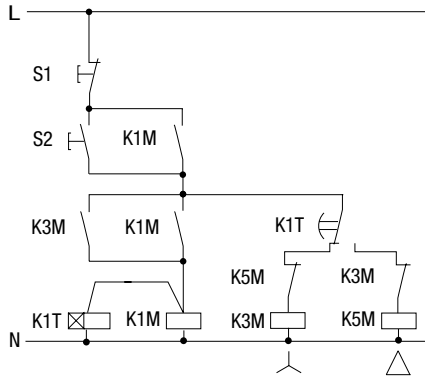

Function of the “easy” circuit diagram:

Start/Stop of switching using external push-button actuators S1 and S2. The mains contactor starts the “easy” timing relay.

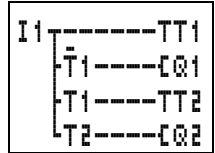

- I1 Mains contactor switched on
- Q1 Star contactor ON
- Q2 Delta contactor ON
- T1 Star-delta changeover time (10 to 30 s, X)
- T2 Wait time between star off, delta on (30, 40, 50, 60 ms, X)

If your “easy” has an integral time switch, you can combine star-delta starting with the time switch function. In this case, use “easy” to switch the mains contactor as well.

4x shift register

You can use a shift register for storing an item of information, such as the sorting of parts into good and bad two, three or four transport steps further on.

A shift pulse and the value (0 or 1) to be shifted are needed for the shift register.

The shift register's Reset input is used to clear any values that are no longer needed. The values in the shift register pass through the register in the following order.

- 1st, 2nd, 3rd, 4th storage position.

Drawing a Circuit Diagram with “easy”

Block diagram of the 4x shift register:

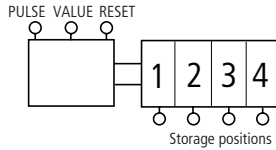

Function:

Pulse	Value	Storage location			
		1	2	3	4
1	1	1	0	0	0
2	0	0	1	0	0
3	0	0	0	1	0
4	1	1	0	0	1
5	0	0	1	0	0
Reset = 1		0	0	0	0

Assign the contents “bad” to the value 0. This ensures that no bad parts will be reused if the shift register is accidentally deleted.

- I1 Shift pulse (PULSE)
- I2 Information (good/bad) to be shifted (VALUE)
- I3 Clear content of the shift register (RESET)
- M1 1st storage position
- M2 2nd storage position
- M3 3rd storage position
- M4 4th storage position
- M7 Marker relay for cyclical pulse
- M8 Cyclical pulse for shift pulse

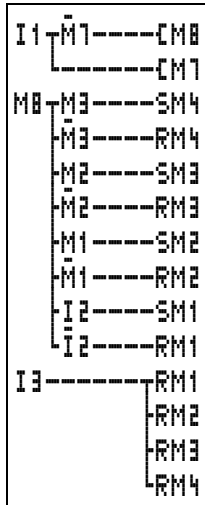

Generate shift pulse

Set 4th storage position

Clear 4th storage position

Set 3rd storage position

Clear 3rd storage position

Set 2nd storage position

Clear 2nd storage position

Set 1st storage position

Clear 1st storage position

Clear all storage positions

How does the shift register work?

The shift pulse is switched on for exactly one cycle. To do this, the shift pulse is generated by evaluating the change from I1 “off” to I1 “on” – the rising edge.

In this way, therefore, the cyclical processing of “easy” is used to trigger the shift pulse.

When I1 is switched on for the first time, marker relay contact M7 is switched off and the break contact is closed during the first pass through the cycle. Thus, the series circuit consisting of I1, break contact M7 (closed) and M8 is switched on. Although M7 is switched on, this does not yet affect contact M7.

The contact of M8 (make contact) was still open during the first cycle so a shift pulse cannot yet be generated. When the relay coil M8 is activated, “easy” transfers the result to the contacts.

In the second cycle, break contact M7 opens. The series circuit is now open. The contact M8 is switched on from the result of the first cycle. Now, all

the storage positions are either set or reset in accordance with the series circuit.

If the relay coils were activated, “easy” transfers the result to the contacts. M8 is now open once more. No new pulse can be formed until I1 has opened, since M7 is open for as long as I1 is closed.

How does the value reach the shift register?

When shift pulse M8 = “on”, the state of I2 (value) is transferred to storage position M1.

If I2 is switched on, M1 is set. If I2 is switched off, M1 is switched off via break contact I2.

How is the result shifted?

“easy” activates the coils in accordance with the circuit connection and its result, from top to bottom. M4 assumes the value of M3 (value 0 or 1) before M3 assumes the value of M2. M3 assumes the value of M2, M2 the value of M1 and M1 the value of I2.

Why are the values not constantly overwritten?

In this example, the coils are controlled only by the “S” and “R” functions, i.e. the values are retained in on or off states even though the coil is not constantly switched on. The state of the coil changes only if the circuit connection up to the coil is switched on. In this circuit, the marker relay is therefore either set or reset.

The circuit connections of the coils (storage positions) are only switched on via M8 for one cycle. The result of activating the coils is stored in “easy” until a new pulse changes the state of the coils.

How are all the storage positions cleared?

When I3 is switched on, all the “R” coils of storage positions M1 to M4 are reset, i.e. the coils are switched off. Since the reset was entered at the end of the circuit diagram, the reset function has priority over the set function.

How can the value of a storage position be transferred?

Use the make or break contact of storage positions M1 to M4 and wire them to an output relay or in the circuit diagram according to the task required.

Running light

An automatic running light can be created by slightly modifying the shift register circuit.

One relay is always switched on. It starts at Q1, runs through to Q4 and then starts again at Q1.

The marker relays for storage positions M1 to M4 are replaced by relays Q1 to Q4.

The shift pulse I1 has been automated by the flasher relay T1. The cycle pulse M8 remains as it is.

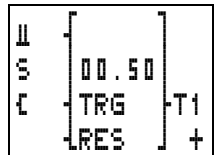

Stairwell lighting

For a conventional circuit you would need at least five space units in the distribution system, i.e. one impulse relay, two timing relays and two auxiliary relays.

“easy” requires only four space units. A fully functioning stairwell lighting system can be set up with five terminals and the “easy” circuit diagram.

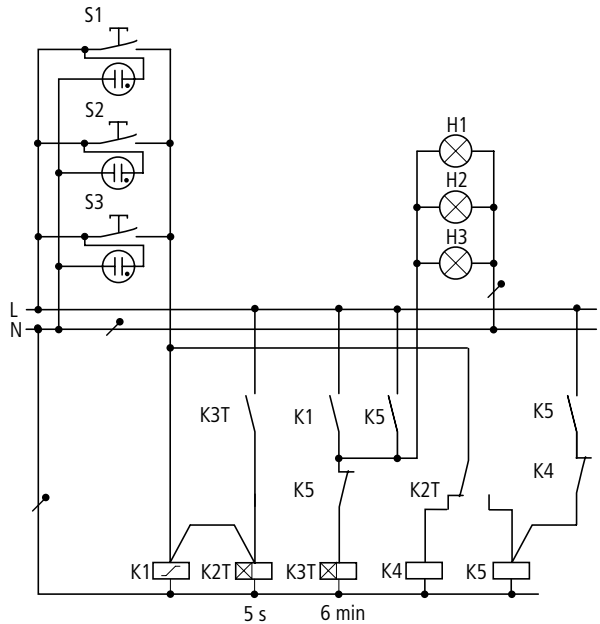

Four such stairwell circuits can be implemented with one “easy” device.

Drawing a Circuit Diagram with “easy”

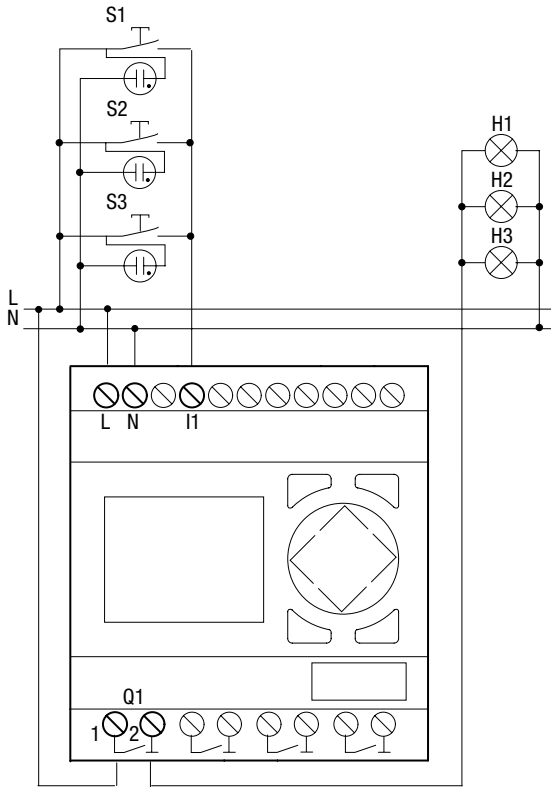

Button pressed briefly	Light ON or OFF. The impulse relay function will even switch off Continuous lighting.
	Light off after 6 min. with Continuous lighting this function is not active.
Button pressed for more than 5 s	Continuous lighting

Example circuits

The “easy” circuit diagram for the functions described above looks like this:



The enhanced “easy” circuit diagram: after four hours, the continuous lighting is also switched off.

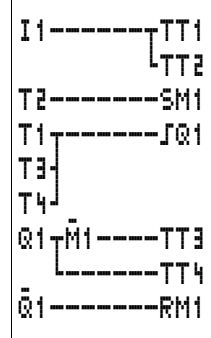

Meaning of the contacts and relays used:

- I1 Button ON/OFF
- Q1 Output relay for light ON/OFF
- M1 Marker relay. This is used to block the “switch off automatically after 6 minutes” function for continuous lighting.
- T1 Cycle pulse for switching Q1 on and off, (I, single-pulse with value 00.00 s)
- T2 Scan to determine how long the button was pressed.
If pressed longer than 5 s,
switch on continuous lighting
(X, on-delayed, value 5 s).
- T3 Switch off after the light has been switched on for 6 min.
(X, on-delayed, value 6:00 min.)
- T4 Switch off after 4 hours continuous lighting
(X, on-delayed, value 4:00 h).

Drawing a Circuit Diagram with “easy”

If you use “easy” with a time switch, you can define both the stairwell lighting and the continuous lighting periods via the time switch.

If you use “easy” with analog inputs, you can optimise the stairwell lighting, via a brightness sensor to suit the lighting conditions.

6 Loading and Saving Circuit Diagrams

You can either use the “easy” interface to save circuit diagrams to a memory card or use EASY-SOFT and a transmission cable to transfer them to a PC.

EASY...-...-X

“easy” models without buttons can be loaded with a circuit diagram via EASY-SOFT or automatically from the fitted memory card every time the power supply is switched on.

Interface

The “easy” interface is covered.



DANGER of electric shock with “easy”-AC units

If the voltage terminals for phase (L) and neutral conductor (N) are swapped over, the connected 230 V/15 V voltage will be present at the “easy” interface. There is a danger of electric shock if the plug is not properly connected or if conductive objects are inserted into the socket.

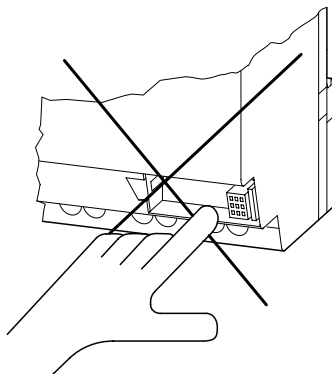

- ▶ Carefully remove the cover with a screwdriver.

To close the slot again, push the cover back onto the slot.

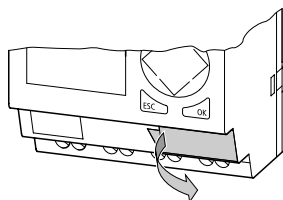

Memory card

The “easy-M-8K” card for EASY412 or “easy-M-16K” for EASY600 are available as accessories.

Circuit diagrams containing all the relevant data can be transferred from the “easy-M-8K” memory card to the EASY600. A transfer, however, in the other direction is not possible.

Each memory card can hold one “easy” circuit diagram.

Information stored on the memory card is “non-volatile” (the information is not lost when the power is switched off), and thus you can use the card to make a backup copy of your circuit diagram and/or to transfer it to another “easy” device.

The following information is saved to the memory card:

- the circuit diagram
- all parameter settings of the circuit diagram
- all display texts with functions
- system settings
 - debounce (input delay)
 - P buttons
 - password
 - retention on/off

► Insert the memory card in the open interface slot.

EASY412 (② = easy-M-8K): EASY600 (② = easy-M-16K):

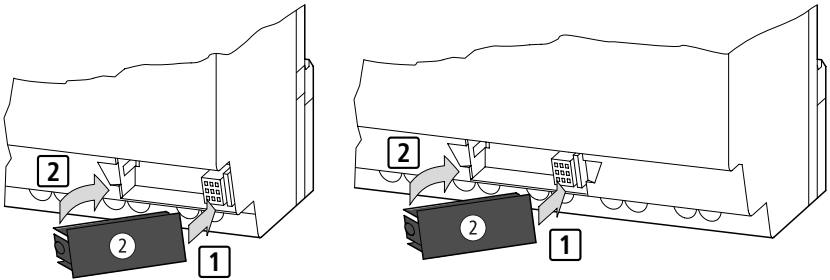

With “easy” you can insert and remove the memory card even if the power feed is switched on, without the risk of losing data.

Loading or storing the circuit diagram

You can only transfer circuit diagrams in Stop mode.

EASY...-...X models without buttons and LCD can be loaded with a circuit diagram automatically from the fitted memory card every time the power supply is switched on. If the circuit diagram on the memory card is not valid, the circuit diagram already in the “easy” unit is retained.

- ▶ Switch to Stop mode.
- ▶ Select “PROGRAM...” from the main menu.
- ▶ Select the “CARD...” menu option.

The “Card...” menu option will only appear if you have inserted a functional memory card.

```
PROGRAM
DELETE PROG
CARD...
```

You can transfer a circuit diagram from “easy” to the card and from the card to the “easy” memory or delete the content of the card.

```
DEVICE-CARD
CARD-DEVICE
DELETE CARD
```



If the operating voltage fails during communication with the card, repeat the last procedure since “easy” may not have transferred or deleted all the data.

After transmission, remove the memory card and close the cover.

Saving a circuit diagram to the card

- ▶ Select “DEVICE-> CARD”.
- ▶ Confirm the prompt with **OK** to delete the contents of the memory card and replace it with the “easy” circuit diagram.

```
REPLACE ?
```

Press **ESC** to cancel.

Loading a circuit diagram from the card

- ▶ Select the “CARD-> DEVICE” menu option.
- ▶ Press **OK** to confirm the prompt if you want to delete the “easy” memory and replace it with the card content.

```
DEVICE-CARD
CARD-DEVICE
DELETE CARD
```

Press **ESC** to cancel.

If a problem occurs during transmission, “easy” will display the message “PROG INVALID”.

```
INVALID PROG
```

This either means that the memory card is empty or that the circuit diagram on the card contains function relays that “easy” does not recognise.

The “time switch” function relays only work with “easy” versions with a real-time clock (type EASY...-.-.C.).

The “analog comparator” function relay is only used with “easy”-DC 24 V DC versions and “easy”-DA.

Relays with text display, jumps and “S”, “R” markers only work with EASY600 versions.



If the memory card is password-protected, the password will also be transferred to the “easy” memory and will be active immediately.

Deleting a circuit diagram from the card

- ▶ Select the “DELETE CARD” menu option.
- ▶ Press **OK** to confirm the prompt and to delete the card content.

```
DELETE ?
```

Press **ESC** to cancel.

EASY-SOFT

EASY-SOFT is a PC program for creating, testing and managing “easy” circuit diagrams.



You should only transfer data between the PC and “easy” using the special PC interface cable, which is available as an optional accessory EASY-PC CAB.



DANGER of electric shock with “easy”-AC units

ONLY the “EASY-PC CAB” cable will guarantee reliable electrical isolation from the interface voltage.

- ▶ Connect the PC cable to the serial PC interface.
- ▶ Insert the “easy” plug in the opened interface.
- ▶ Activate the Status display on the “easy”

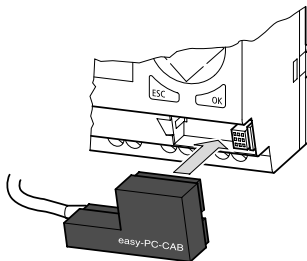

“easy” cannot exchange data with the PC while the circuit diagram display is on screen.

Use EASY-SOFT to transfer circuit diagrams from your PC to “easy” and vice versa. Switch “easy” to Run mode from the PC to test the program using the current wiring.

EASY-SOFT provides extensive help on how to use the software.

- ▶ Start EASY-SOFT and click on Help.

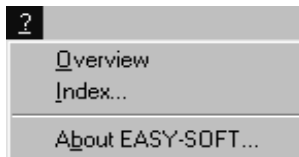

The on-line help provides all additional information about EASY-SOFT that you will need.

If a problem occurs during transmission, “easy” will display the message “PROG INVALID”.



INVALID PROG

- Check whether the circuit diagram contains a function relay that “easy” does not recognise:

The “time switch” function relays only work with “easy” versions with a real-time clock (type EASY...-...-C.).

The “analog comparator” function relay is only used with “easy”-DC 24 V DC versions and “easy”-DA.

Relays with text display, jumps and “S” markers only work with EASY600 versions.



If the operating voltage fails during communication with the PC, repeat the last procedure. It is possible that not all the data was transferred between the PC and “easy”.

- After transmission, remove the cable and close the cover.

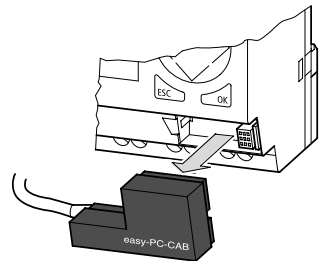

7 “easy” Settings

Settings can only be carried out on “easy” models provided with buttons and LCD display.

EASY-SOFT from V 2.1 upwards can be used to set all models.

Password protection

The “easy” circuit diagram, function relay settings and system parameters can be password protected.

In this case the password consists of a value between 0001 and 9999. The number combination 0000 is used to delete a password.

Password protection blocks access to the circuit diagram menu and System menu and thus offers protection against

- unauthorised starting or modification of the circuit diagram
- modification of function relay parameters via the circuit diagram
- transfer of a circuit diagram from and to the memory card
- modification of system parameters
 - Set new password
 - Debounce (input delay) ON/OFF
 - P buttons ON/OFF
 - Menu language selection



Only parameters marked with “_” are password-protected. Parameters marked with “+” can still be modified via the PARAMETER menu.

The password does not offer protection against:

- changing between operating modes Run or Stop.
- setting the clock
- access to the parameters of function relays marked with “+”.



A password that has been entered in “easy” is transferred to the memory card together with the circuit diagram, irrespective of whether it was activated or not.

If this “easy” circuit diagram is loaded from the memory card, the password will also be transferred to “easy” and become activated immediately.

Setting the password

Passwords can be set in the System menu in both Run or Stop operating modes. If, however, a password is already activated, you cannot change to the System menu.

- ▶ Press **DEL** and **ALT** to call up the System menu.
- ▶ Select the menu option “PASSWORD...” to enter the password.

If a password has not been entered already, “easy” will switch directly to the password display and show four dashes: no password available.



- ▶ Set the password using the cursor buttons:
 - < > move to the 4-digit entry field
 - < > select digit in password
 - ^ v set a value between 0 and 9.

- ▶ Save the new password by pressing **OK**.

“easy” will hide a valid password with XXXX.



Press **OK** or **ESC** to exit the password display.

The password is now valid but not yet activated.

Activating the password

You can activate a valid password in three different ways:

automatically when “easy” is switched on again
automatically after loading a protected circuit diagram from the memory card
via the password menu

- ▶ Press **DEL** and **ALT** to call up the System menu.
- ▶ Open the password menu via the menu option “PASSWORD...”.

“easy” will only show this menu if a password is present.

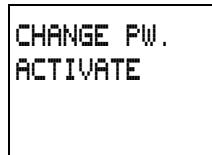

Make a note of the password before you activate it. If the password entry is no longer known, “easy” can still be unlocked, however, the circuit diagram and other settings will be lost.

- ▶ Select “ACTIVATE” and press **OK**.

The password is now active. “easy” will automatically return to the Status display.

You must unlock “easy” using the password before you can edit a circuit diagram or enter the System menu.

Unlocking “easy”

Unlocking “easy” will deactivate the password. You can re-activate password protection later via the password menu or by switching the power supply off and on again.

- ▶ Press **OK** to switch to the main menu.

The “PASSWORD...” entry will flash.

- ▶ Press **OK** to enter the password entry menu.



```
PASSWORD...
STOP
PARAMETER
SET CLOCK..
```



If “easy” shows “PROGRAM...” in the main menu instead of “PASSWORD...”, this means that there is no password protection active.

“easy” will display the password entry field.

- ▶ Set the password using the cursor buttons.
- ▶ Confirm with **OK**.



```
ENTER PW █
XXXX
```

If the password is correct, “easy” will switch automatically to the Status display.

The “PROGRAM...” menu option is now accessible so that you can edit your circuit diagram.

The System menu is also accessible.



```
PROGRAM...
STOP
PARAMETER
SET CLOCK..
```

Changing or deleting a password

- ▶ Press **DEL** and **ALT** to call up the System menu.
- ▶ Open the password menu via the menu option "PASSWORD...".

The "CHANGE PW" entry will flash.

```
CHANGE PW.
ACTIVATE
```

"easy" will only show this menu if a password is present.

- ▶ Press **OK** to enter password entry menu.
- ▶ Use < > to move to the 4-digit entry field.
- ▶ Modify the four password digits using the cursor buttons.
- ▶ Confirm with **OK**.

```
ENTER PW █
-----
```

```
ENTER PW
  1005
```

Press **ESC** to exit the password display.

Deleting

Use number combination 0000 to delete a password.

If a password has not been entered already, "easy" will show four dashes:

```
ENTER PW █
-----
```

Password incorrect or not known

If you no longer know the exact password, you can try to re-enter the password several times.

Entered an incorrect password?

- ▶ Re-enter the password.



After the fourth entry attempt “easy” will ask whether you wish to delete the circuit diagram and data.

- ▶ Press

ESC: No entry will be deleted.

OK: Circuit diagram, data and password will be deleted.



“easy” will return to the Status display.



If you no longer know the exact password, you can press **OK** to unlock the protected “easy”. The saved circuit diagram and all function relay parameters will be lost.

Pressing **ESC** will retain the circuit diagram and data. You can then make another four attempts to enter the password.

Changing the menu language

EASY412 provides five menu languages and EASY600 provides ten. These can be set as required via the System menu.

Language	LCD display	Abbreviation
English	ENGLISH	GB
German	DEUTSCH	D
French	FRANCAIS	F
Spanish	ESPANOL	E
Italian	ITALIANO	I
Additional languages with EASY600		
Portuguese	PORTUGUES	–
Dutch	NEDERLANDS	–
Swedish	SVENSKA	–
Polish	POLSKI	–
Turkish	TURKCE	–



Language selection is only possible if “easy” is not password-protected.

- ▶ Press **DEL** and **ALT** to call up the System menu.
- ▶ Select “GB D F E I..” as required to modify the menu language.

The language selection for the first entry “GB” is displayed.

- ▶ Use \wedge or \vee to select the new menu language, e.g. Italian.
- ▶ Confirm with **OK**.

“easy” will now show the new menu language.

Press **ESC** to return to the Status display.

```

ENGLISH
GB D F E I
    
```

```

PASSWORD...
RIT.INGR. ON
P TASTO ON
GB D F E I...
    
```

Changing parameters

“easy” allows you to change function relay parameters such as times and counter setpoints without having to call up the circuit diagram. This is possible regardless of whether “easy” is running a program or is in Stop mode.

- ▶ Press **OK** to switch to the main menu.
- ▶ Start the parameter display by selecting **PARAMETER**.

A complete parameter set will be shown. In the example these are the parameters for a timing relay T1.

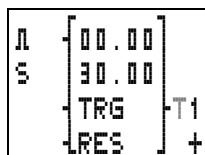

The following requirements must be fulfilled for a parameter set to be displayed and accessed:

- a function relay must have been included in the circuit diagram
- the parameter set has been enabled for access, indicated by the “+” character at the bottom right of the display.

Use the **PARAMETER** menu to access and modify accessible parameter sets. Parameter sets for which access is not enabled are not displayed. “easy” therefore allows you to protect parameters with the use of a password.



You can enable or disable parameter access using the parameter “+” or “-” characters respectively in the circuit diagram.

- ▶ Use \wedge or \vee to scroll through the parameter sets. For this the cursor must be located on the identifier of the function relay, in this case T1.

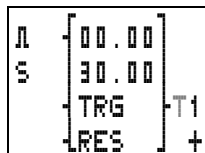

- ▶ Change the values for a parameter set:
 - < > Move between the parameters
 - ^ v Change the value of a parameter
 - OK** Save parameter or
 - ESC** Retain previous setting.

The cursor should still be on the identifier T1.

Press **ESC** to leave the parameter display.



The parameter display is opened via the PARAMETER menu. “I” coil terminals for counters and times are not displayed here, even if they have been wired.

Variable parameters for function relays

You can modify the relay parameters used in the circuit diagram in three different ways:

All circuit diagram parameters can be adjusted in Stop mode via the circuit diagram.

Setpoints can be modified in Run mode via the circuit diagram.

Setpoints can be modified via the PARAMETER menu.

The following setpoints can be modified:

the time value for timing relays

the counter setpoints of counter relays

the day and ON/OFF times of time switches

the comparison setpoint of analog comparators.

In Run mode “easy” operates with a new setpoint as soon as it has been modified in the parameter display and saved with **OK**.

Example: Changing switch times for outside lighting

The outside lighting of a building is automatically switched on from 19:00 to 23:30 Mondays to Fridays in the “easy” circuit diagram.

The parameter set for the time switch function relay 1 is saved in channel “A” and looks like this.

```

    [ MO-FR ]
      15:20 01
ON - 19:00 A
OFF- 23:30 +
    
```

The outside lighting is now required to switch on between 19:00 and 22:00 on Saturdays.

- ▶ Select PARAMETER from the main menu.

The first parameter set is displayed.

- ▶ Use ^ or v to scroll through the parameter sets until channel A of time switch 1 is displayed.
- ▶ Press ^ to select the next empty parameter set, in this case channel B of time switch 1.

```

    [ MO ]
      15:21 01
ON - ---:-- B
OFF- ---:-- +
    
```

The current time is 15:21.

- ▶ Change the value for the day interval from MO to SA:
 - < > Move between the parameters
 - ^ v Change value.

```

    [ SA ]
      15:21 01
ON - ---:-- B
OFF- ---:-- +
    
```

- ▶ Set the switching on time to 19:00.

```

    [ SA ]
      15:21 01
ON - 19:00 B
OFF- ---:-- +
    
```

Setting the time

- ▶ Set the switching off time to 22:00.
- ▶ Press **OK**.

```
  [ SA ]  
  15:21 01  
ON 19:00 E  
OFF 22:00 +
```

“easy” will save the new parameters. The cursor will remain in the contact field on channel identifier “B”.

```
  [ SA ]  
  15:21 01  
ON 19:00 E  
OFF 22:00 +
```

Press **ESC** to leave the parameter display.

The time switch will now also switch on at 19:00 on Saturdays and switch off at 22:00.

Setting the time

“easy”-C models are fitted with a real-time clock. This allows the time switch function relay to be used for timed switching operations.

If the clock is not set yet or if “easy” is switched on after the battery backup time has expired, the clock will start with the MO setting and the number of the current operating system, in this case 01:00 for EASY412 and 02:00 for EASY600.

```
I12345678  
00000000 MO  
0000 01:00  
01234 STOP
```

```
.....  
MO 02:00  
.....STOP
```

The “easy” clock has a one-week cycle so that weekdays and times have to be set.

- ▶ Select SET CLOCK from the main menu.

This will open the menu for setting the time.

- ▶ Select SET CLOCK.



- ▶ Set the values for day and time.

< > Move between the parameters

^ v Change the value of a parameter

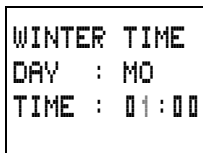

OK Save day and time or
ESC Retain previous setting.

Press **ESC** to leave the time setting display.

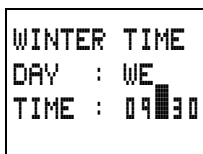

Changing between winter/summer time (DST)

“easy”-C models are fitted with a real-time clock. The clock can be toggled between winter and summer time using the cursor buttons.

- ▶ Select SET CLOCK from the main menu.

This will open the menu for setting the time.

Select menu option “WINTER TIME” or “SUMMER TIME” as required.



Changing to winter time

“easy” will display “SUMMER TIME” as the next possible option if winter time is already set.

- ▶ Otherwise select “WINTER TIME” and press **OK**.

“easy” will set the clock one hour back, e.g. from 17:43 Sunday to 16:43 Sunday.

The display will then switch to “SUMMER TIME”.

Activating debounce (input delay)

Changing to summer time

- ▶ Select “SUMMER TIME” and press **OK**.

“easy” will set the clock one hour forward, e.g. from 12:30 Wednesday to 13:30 Wednesday.



```
SET CLOCK  
SUMMER TIME
```

The display will then switch to “WINTER TIME”.



With EASY412, operating system 1.0:
The weekday is not changed automatically with the time. If you change the time around midnight you must change the weekday as well.

Activating debounce (input delay)

Input signals can be evaluated by “easy” with a debounce delay. This enables, for example, the trouble-free evaluation of switches and push-button actuators subject to contact bounce.

In many applications, however, very short input signals have to be monitored. In this case, the debounce function can be switched off.

- ▶ Press **DEL** and **ALT** to call up the System menu.
- ▶ Select the SYSTEM menu.



If “easy” is password-protected you cannot open the System menu until you have “unlocked” it.

Set the Debounce mode using the menu options “DEBOUNCE OFF”/ “DEBOUNCE ON”.

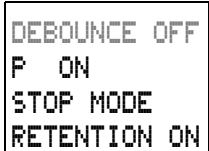

```
DEBOUNCE OFF  
P ON  
STOP MODE  
RETENTION ON
```

Deactivating debounce (input delay)

If “easy” is showing “DEBOUNCE ON” in the display, this means that Debounce mode has already been deactivated.

- ▶ Otherwise select “DEBOUNCE OFF” and press **OK**.

If Debounce mode is deactivated the display will show “DEBOUNCE ON”.

Activating debounce (input delay)

- ▶ Select “DEBOUNCE ON” and press **OK**.

If Debounce mode is activated the display will show “DEBOUNCE OFF”.

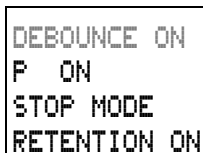

Press **ESC** to return to the Status display.



How “easy” input and output signals are processed internally is explained in chapter 9, from page 175.

Activating and deactivating P buttons

Even though the cursor buttons (P buttons) have been set as push-button actuator inputs in the circuit diagram, this function is not activated automatically. This prevents any unauthorised use of the cursor buttons. The P buttons can be activated in the System menu.



If “easy” is password-protected you cannot open the System menu until you have removed the password.

The P buttons are activated and deactivated via the “P ON/P OFF” menu option.

- ▶ Press **DEL** and **ALT** to call up the System menu.
- ▶ Select the SYSTEM menu.
- ▶ Move to the “P ” menu option

```
DEBOUNCE OFF
P ON
STOP MODE
RETENTION ON
```

Activating the P buttons

If “easy” is showing P OFF, this means that the P buttons are already active.

- ▶ Otherwise select “P ON” and press **OK**.

```
DEBOUNCE OFF
P OFF
STOP MODE
RETENTION ON
```

The P buttons are now active.

- ▶ Press **ESC** to return to the Status display.

The P buttons are only active in the Status display. In this display you can use the P buttons to activate inputs in your circuit diagram.

Deactivating the P buttons

- ▶ Select “P OFF” and press **OK**.

The P buttons are now deactivated.



The P buttons are automatically deactivated when loading a circuit diagram from the memory card or via EASY-SOFT to “easy”, or when deleting a circuit diagram in “easy”.

Startup behaviour

The startup behaviour is an important help during the commissioning phase. The circuit diagram which “easy” contains is not as yet fully wired up or the system or machine is in a state which “easy” is not

permitted to control. The outputs should not be controlled when “easy” is switched on.

Setting the startup behaviour



The EASY...-...X models can only be started in Run mode.

Requirement: “easy” must contain a valid circuit diagram.

► Switch to the System menu.



If “easy” is protected by a password, the System menu will not be available until “easy” is unlocked (see the section Unlocking easy from page 136).

► Specify in which operating mode “easy” should start when the power supply is switched on (see the figure at the top of page 149).



MODE: RUN/STOP is a toggle menu. The menu always displays the operating mode into which you can change.

The default setting for “easy” is for STOP MODE to be displayed. In other words, “easy” starts in Run mode when the power is switched on.

Behaviour when the circuit diagram is deleted

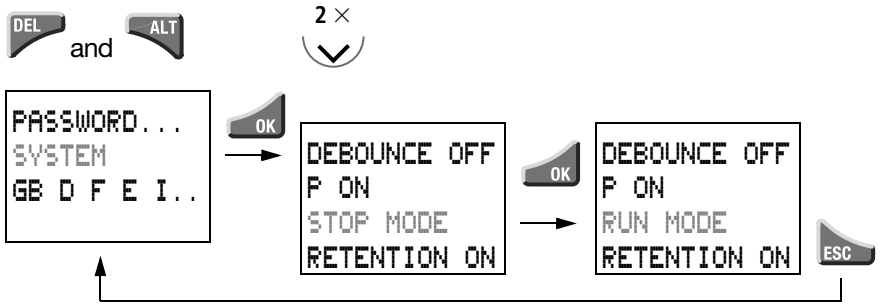

Startup behaviour	Menu displayed	Status of "easy" after startup
"easy" starts in Stop mode	RUN MODE	"easy" is in Stop mode
"easy" starts in Run mode	STOP MODE	"easy" is in Run mode

Behaviour when the circuit diagram is deleted

The setting for the startup behaviour is an "easy" device function. When the circuit diagram is deleted this does not result in the loss of the setting selected.

Behaviour during uploading and downloading to the card or PC

When a valid circuit diagram is transferred from "easy" to a memory card or the PC or vice versa, the setting is still retained.



The EASY...-...-X models can only be started in Run mode.

Possible faults

"easy" will not start in Run mode

"easy" does not contain a circuit diagram.

You have selected MODE: STOP in the MODE RUN/STOP menu (the menu displayed is thus MODE: RUN).

8 Retention

It is a requirement of system and machine controllers for operating states or actual values to have retentive settings. What this means is that the values will be retained safely even after the supply voltage to a machine or system has been switched off and are also retained until the next time the actual value is overwritten.

Requirements

Permitted “easy” models

Retentive actual values can be set with EASY412-D.-.. (via the SYSTEM menu) as well as EASY600 for the following markers and function relays.

Permitted markers and function relays

It is possible to retentively store (non-volatile memory) the actual values (status) of markers, timing relays and up/down counters.

The following markers and function relays can be set to have retentive actual values:

EASY412-D.-..

Marker relays	M13, M14, M15, M16
Timing relay	T8
Up/down counter	C8

EASY600

Markers	M13, M14, M15, M16
Text function relays	D1 to D8
Timing relays	T7, T8
Up/down counters	C5, C6, C7, C8



The Retention setting always applies to all of the relays listed. Individual markers or function relays cannot be set retentively.

The retentive data of EASY...-...X models with a fitted memory card is deleted when the power supply is switched on.



Note

The retentive data is kept every time the power supply is switched off. Data security is assured for 100 000 write cycles.

Setting retention

Requirement: In this case “easy” must be in Stop mode

- ▶ Switch to the System menu.



If “easy” is protected by a password, the System menu will not be available until “easy” is unlocked (see chapter 7 from page 136).

- ▶ Switch on the Retention function (see figure on page 153 above).



The menu item RETENTION ON/OFF is a toggle menu. The menu always displays the operating mode into which you can change.

The default setting of “easy” as it is supplied is the display RETENTION ON. With this setting “easy” runs without retentive actual value data, when a valid circuit diagram is present. When “easy” is in Stop mode or has been switched to a de-energized state, all actual values are cleared.

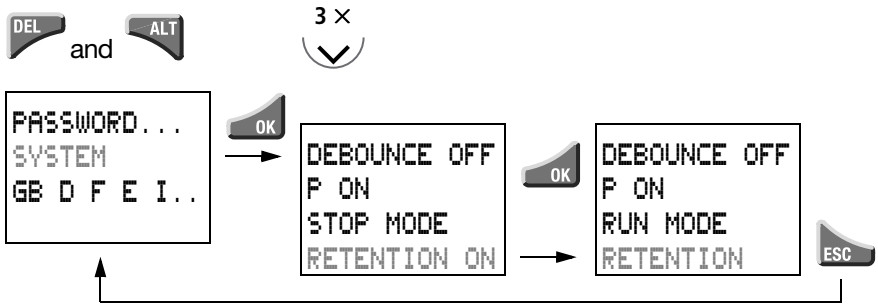

Retentive behaviour	Menu displayed	Behaviour: M13, M14, M15, M16, C8, T8, (D1 to D8, C5, C6, C7, T7) when the unit is switched off and on again
No retentive actual values	RETENTION ON	All actual values will be cleared when the unit changes from Run to Stop mode or when the power supply is switched off.
Retentive actual values	RETENTION	All actual values will be safely stored when the unit changes from Run to Stop mode or when the power supply is switched off. They can then be used or deleted.

Deleting retentive actual values

The retentive actual values are cleared if the following is fulfilled (applies only in Stop mode):

When the circuit diagram is transferred from EASY-SOFT (PC) or from the memory card to “easy”, the retentive actual values are reset to 0 (marker = off). This also applies when there is no program on the memory card. In this case the old circuit diagram is retained in “easy”.

When there is a changeover from retention activated (the display shows RETENTION OFF) to retention deactivated (the display shows RETENTION ON).

When the circuit diagram is deleted via the DELETE PROG menu.

Transfer retentive behaviour

The setting for retentive behaviour is a circuit diagram setting; in other words, the setting of the retention menu may also under certain circumstances be transferred to the memory card or by uploading or downloading from the PC.

Circuit diagram transfer (behaviour)

EASY-SOFT, V 1.0 → EASY412-D.-..

When the circuit diagram is transferred (downloaded), the retentive behaviour must be set manually on the EASY412-DC... unit. In this version of the software, the relevant menu is not provided.

EASY-SOFT, V 1.1 → EASY412-D.-..

EASY-SOFT, V 1.1 does not support editing of the retentive behaviour. If an EASY412-DC.. circuit diagram with activated retention is loaded into EASY-SOFT, V 1.1, saved and then transferred back to the EASY412-DC.., the retentive behaviour setting will be retained.

EASY412-D.-.. → Memory card

When transfer is in this direction, the actual values are retained in “easy”. The retention setting is transferred to the card.

EASY412-D.-.. → EASY-SOFT, V 1.0, V 1.1

The “easy” circuit diagram is stored. The actual values are retained in “easy”.

EASY412-D.-.., EASY600 → EASY-SOFT, V 2.*

The “easy” circuit diagram is stored. The actual values are retained in “easy”. All “easy” circuit diagram settings are transferred to the “EAS” file.

EASY-SOFT, V 2.* → EASY412-D.-.., EASY600

The transfer to EASY-SOFT is carried out according to the relevant settings.

Changing the operating mode or the circuit diagram

When the operating mode is changed or the “easy” circuit diagram is modified, the retentive data is normally saved together with their actual values. The actual values of relays no longer being used are also retained.

Changing the operating mode

If you change from Run to Stop and then back to Run, the actual values of the retentive data will be retained.

Modifying the “easy” circuit diagram

If a modification is made to the “easy” circuit diagram, the actual values will be retained.



Note

Even when the retentive relays M13, M14, M15, M16 (D1 to D8) and the function relays C8, T8 (C5, C6, C7, T7) are deleted from the circuit diagram, the retentive actual values will be retained after the changeover from Stop to Run as well as after the power supply is switched off and on. Should these relays be used again in the circuit diagram, they will still have their former actual values.

Changing the startup behaviour in the SYSTEM menu

The retentive actual values in “easy” will be retained irrespective of the MODE RUN or MODE STOP settings.

Retentive auxiliary relays (markers)

How the retention works

The retentive markers M13, M14, M15, M16, D1 to D8 should be used in conjunction with the following coil functions.

Set	S M., D..
Impulse relay	∩ M., D..
Reset	R M., D..



Note

When the condition for resetting the marker is fulfilled, the marker is reset.

It is essential that you note the following points:

Due to the operation of “easy” the make contact will remain closed and the break contact will remain open. If the Reset condition is active when the power supply is switched on, the state of the contact before power on will be retained for one cycle.

This behaviour can result in a flicker effect in a lamp or a solenoid valve.

Be sure to pay close attention to the example circuits for the individual coil functions.

The following coil functions are not permitted:

∩ M13 to ∩ M16, ∩ D1 to ∩ D8

Examples

S/R coil (break contact)

Task:

In your application you need to remember whether a screw has been inserted or not. When your installation switches on, it is important that a screw which has already been screwed in place is not screwed in again - otherwise there could be permanent damage to the workpiece or the production line even shut down.

Contacts and relays used:

- I3 Screw detected
- Q2 Blow pulse to transport screw
- M8 Blow screw command
- M14 Screw present (retentive)
- M9 Workpiece transported away,
Reset M14

Circuit diagram (part):

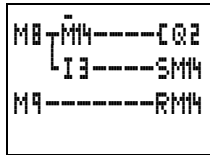

Signal diagram:



It is always the contact state “Make contact” which is displayed.

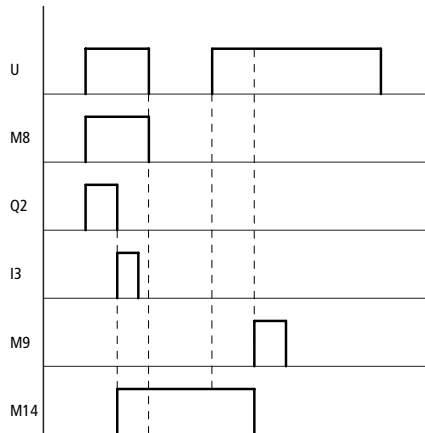

U = Supply voltage



The break contact of the retentive marker M14 is used. No enabling time is required for output Q2.

Impulse relay

Task:

After a power failure the lights in a stairwell should resume their previous switching state.

Contacts and relays used:

- T2 Enable after first cycle
- I1 Push-button actuator
- Q1 Lamp output
- M15 Impulse relay (retentive)

Circuit diagram:

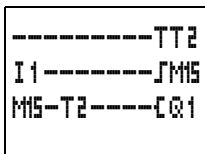

Parameter display:

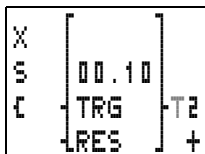

Signal diagram:

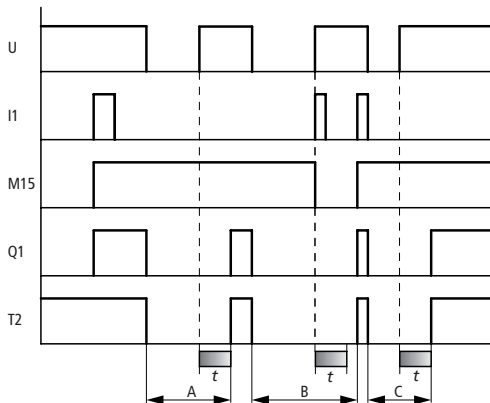

U = Supply voltage

Range A:

Q1 is switched on. The power supply is switched off. I1 is switched off. After the I1 is switched on, M15 is switched on and remains on. If the switching of I1 would switch off M15, the opposite would apply in the same way, and M15 would remain switched off.

Range B:

The power supply is switched off. I1 is switched on. After the switch on in the first “easy” cycle M15 is on. The fact that M15 and T2 are connected in series (enable time) prevents a flickering pulse on Q1.

Range C:

M15 is switched on and remains set until the next time I1 switches on.

S/R function

Task:

After a power failure the lights in a stairwell should resume their previous switching state.

Contacts and relays used:

- T2 Enable after first cycle
- I1 Push-button actuator
- M1 Push-button actuator pulse (rising edge detection)
- M2 Pulse limitation (one cycle)
- Q1 Lamp output
- M15 Impulse relay (retentive)

Circuit diagram:

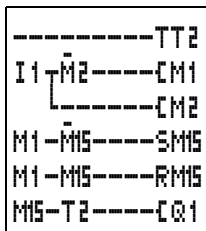

Parameter display:

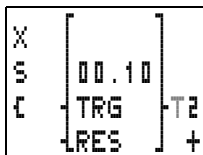

Signal diagram:

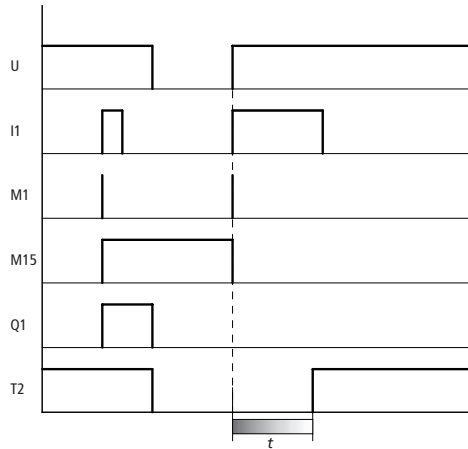

U = Supply voltage

The circuit above functions in the same way as an impulse relay switch. The make contact will remain switched on in the first “easy” cycle if

a coil is actuated by the make contact of a retentive marker (series and parallel connection both apply here too) and

when the power is switched on, the reset condition for this retentive marker is on.

The enable time T2 prevents Q1 from flickering.

Retentive timing relay

How the retention works

The retentive timing relays T7, T8 can be operated retentively in all six different switching functions. The retention setting only makes sense under certain conditions for the switching functions. These can be subdivided into groups 1 and 2.

If these conditions are not fulfilled, the actual value will be cleared when the power is restored. If the R coil is actuated, the actual value will also be cleared.

Group 1	<p>On-delayed (example page 163)</p> <p>On-delayed switching with random range (example page 163)</p> <p>Single-pulse (example page 168)</p> <p>Flashing (example page 169)</p>
Group 2	<p>Off-delayed (example page 166)</p> <p>Off-delayed switching with random time range (example page 166)</p>

Retention with group 1

Requirement:

When the supply voltage is switched on, actuated trigger coils TT7, TT8 retain their “1” state (switched on) until the set time period has elapsed. This can be implemented using retentive markers or inputs connected to the power.

Retention with group 2

Requirement:

When the supply voltage is switched on, actuated trigger coils TT7, TT8 retain their “0” state (switched off) until the set time period has elapsed. This can be implemented using retentive markers or inputs connected to the power.

Examples

On-delayed, switching on-delayed with random range, retentive

Task 1 (on-delayed):

A drive motor must start up 30 seconds after the unit is first switched on.



This task is implemented using the input which retains the 1 state on switch-on.

Contacts and relays used:

- I1 Switch on
- Q2 Motor
- T8 Delay time

Circuit diagram:

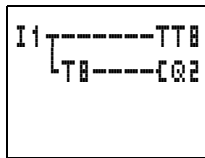

Parameter display:

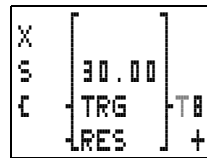

Signal diagram:

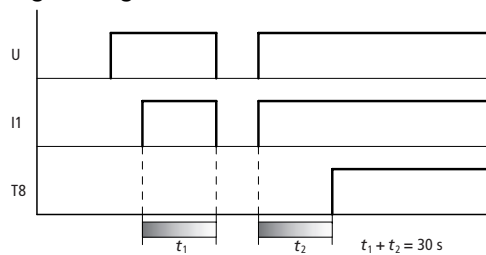

U = Supply voltage



I1 must be switched on when the voltage is switched back on.

Task 2

A conveyor belt is to be run empty. This no-load running is implemented by using a timing relay to keep the belt running following the STOP BELT command until the preset time has elapsed. If this procedure is interrupted by an interruption to the power supply, the belt is only permitted to run empty after switch-on for the remainder of the preset time period.



This task is implemented using retentive markers.

Contacts and relays used:

- T6/T7 Single pulse timers
- I2 Start conveyor belt
- Q1 Conveyor belt motor
- I3 Stop conveyor belt
- M16 Stop selected
- T8 Remaining time

Circuit diagram:

Parameters entered:

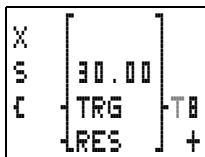
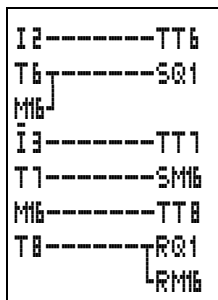

Setting T6, T7 Time: 00.00 s

I2 and I3 are converted to cycle pulses by T6 / T7. Only the pressing of the push-button actuators is

Retentive timing relay

recognized. Should they remain constantly depressed, malfunctions would ensue.



In the above example T7 does not have to be retentive.

Signal diagram:

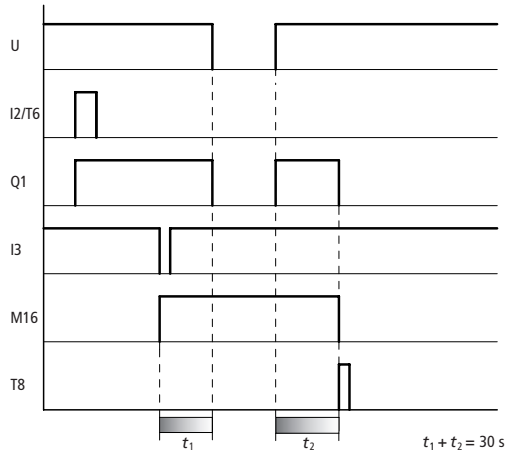

U = Supply voltage

The make contact of T8 closes for one “easy” cycle and resets M16, Q1.

Off-delayed, off-delayed switching with random time range, retentive

Task:

No-load running of a conveyor belt.

Contacts and relays used:

- T6/T7 Single pulse timers
- I2 Start conveyor belt
- Q1 Conveyor belt motor
- I3 Stop conveyor belt
- M16 Stop selected
- T8 Remaining time

Circuit diagram:

Parameters entered:

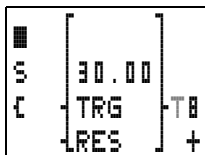
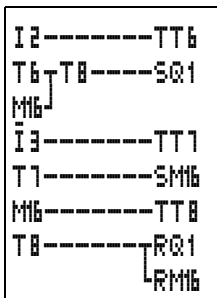

Setting T6, T7 \square Time:
00.00 s

I2 and I3 are converted to cycle pulses by T6 / T7. Only the pressing of the push-button actuators is recognized. Should they remain constantly depressed, malfunctions would ensue.



In the above example T7 does not have to be retentive.

Retentive timing relay

Signal diagram:

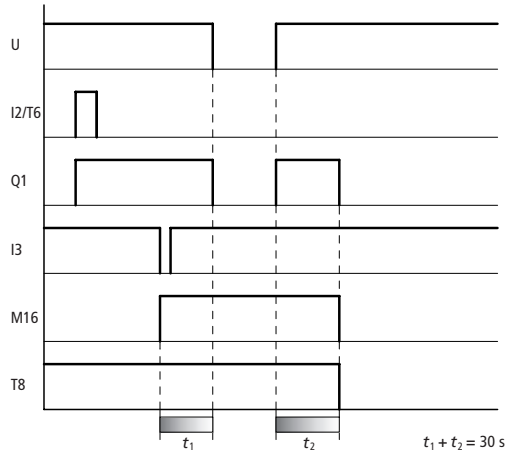

U = Supply voltage

Single-pulse timing relays, retentive

Single-pulse timing relays are suitable for metering adhesives, liquids etc.

Task: A lubricating device is to dispense at all times a constant quantity of oil.

Contacts and relays used:

- I1 Start lubrication
- Q1 Oil valve
- T8 Oil time

Circuit diagram:

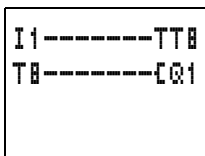

Parameters entered:

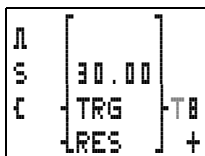

Signal diagram:

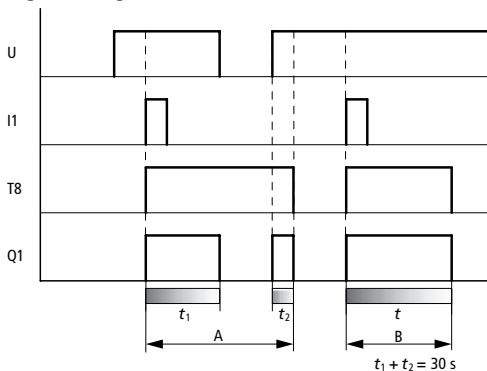

U = Supply voltage

Range A: In this case the power supply is interrupted. When the power supply is restored, the remaining pulse time runs on until finished.

Range B: The time period runs down in this range without interruption.

Flashing switch operation, retentive

Task:

A flasher function is used to lower an ink stamp at identical time intervals to print an area and then to raise the stamp for areas where no printing is required.

Contacts and relays used:

Q1 Valve

T8 Time

Circuit diagram:

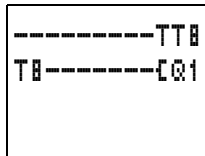

Parameters entered:

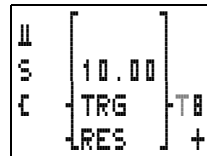

Signal diagram:

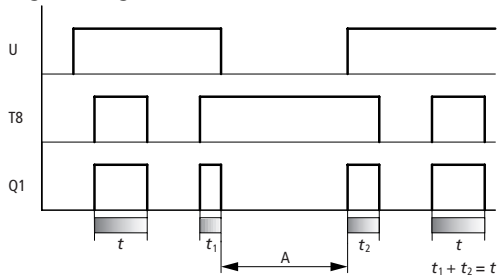

U = Supply voltage

Range A:

In this case the power supply is interrupted.

Following another switch-on, the remaining time runs on until finished.

Retentive Up/down counters C7, C8



How the retention works

The actual value of counter C7, C8 is retentive.

When the condition for resetting the counter is satisfied, the actual value of the counter will be reset.

Examples

Counting parts

Task 1

Parts are packed automatically in a shipping carton. Even if there is a power outage the correct number should still be packed into the carton. When the carton is full, the carton is removed manually and the counter reset.

Contacts and relays used:

- I5 Count parts
- I6 Reset counter
- Q1 Stop parts, signal lamp
- C8 Up counter

Circuit diagram:

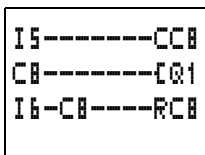

Parameters entered:

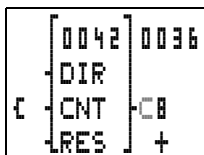

Signal diagram:

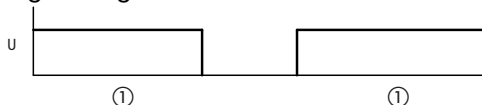

① The numerical value 36 is retained even after a power outage.

U = Supply voltage

Operating hours counter for maintenance intervals

Task 2

Every 1000 hours the system or machine must be checked for possible defects. Filters and transmission oil must be changed and the bearings lubricated.

Contacts and relays used:

- T8 Clock pulse
- M16 Block double pulse
- Q4 Warning light, 1000 h reached
- C8 Up counter
- I1 Reset

Circuit diagram:

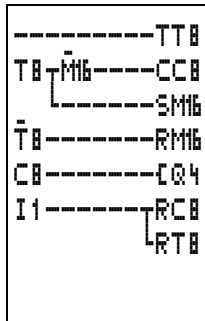

Parameters entered:

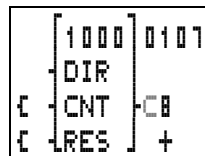
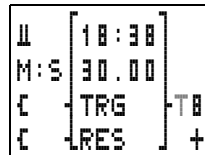

Function of the “easy” circuit diagram:

T8 provides the clock pulse. When a time of $t = 30$ min. is selected the counting period amounts to $2 \times t = 60$ min. Every hour one impulse is counted.

The up counter C8 triggers a warning message at 1000 by means of Q4.

For the clock pulse to be correct when there is a power outage, T8 must be retentive.

M16 prevents C8 from accidentally receiving a counter pulse when the power is switched back on if there was a power outage during the counting period.

Both M16 and C8 must retain their actual values at power outage so that the 1000 hours of operating with interruptions in the power supply can be counted.

I1 (for example, a key-operated switch) is used to reset the counter.

Signal diagram:

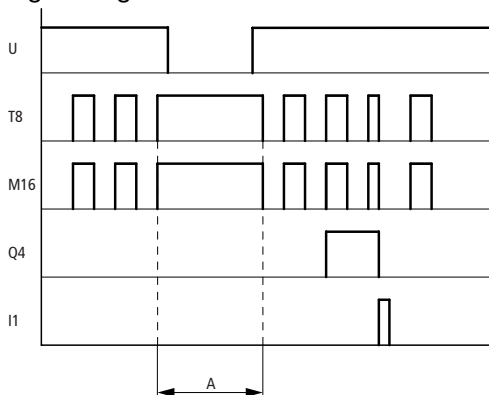

U = Supply voltage

Range A:

Value before power outage: 107

Value after power restored: 107

The timing relay T8 terminates the counting period after power is restored.

Automatic lubrication at constant intervals and with a constant quantity of lubricant

Task 3:

60 minutes after the last lubrication the bearings of a
machine must be lubricated for 30 seconds.

Contacts and relays used:

- T1 Clock pulse
- M15 Lubricate
- Q1 Valve
- T8 Lubrication time
- C8 Up counter

Circuit diagram:

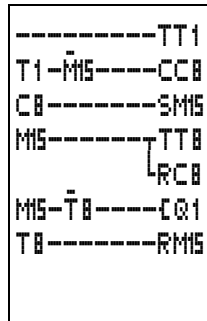

Parameters entered:

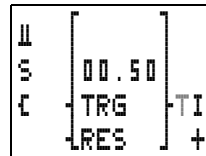

Parameter display:

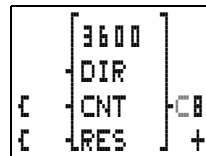

Parameters entered:

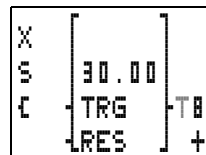

Function of the “easy” circuit diagram:

T1 provides the clock pulse. When a time of $t = 0.5$ seconds is selected the counting period amounts to $2 \times t = 1$ s. One impulse is counted every second.

The up counter C8 switches on valve Q1 via M15 at 3600 counting pulses ($3600 \text{ s} = 1 \text{ h}$).

M15 resets C8 and prepares C8 for the next hour. To stop C8 continuing to count, the break contact of M15 blocks the counting pulses.

T8 is actuated by means of M15. Once T8 has timed out, M15 and T8 will be reset.

In order that both the time elapsed since the last lubrication (counter C8) and also the lubrication pulse remains constant in the event of a power outage, C8, M15 and T8 must be retentive.

Signal diagram:

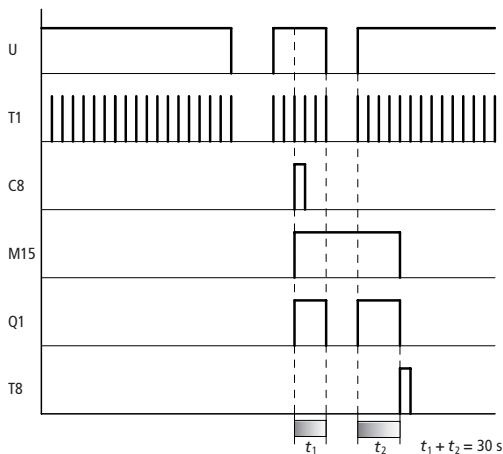

U = Supply voltage

9 Inside “easy”

“easy” circuit diagram cycle

In conventional control systems, a relay or contactor control processes all the circuit connections in parallel. The speed with which a contactor switches is thus dependent on the components used, and ranges from 15 to 40 ms for relay pick-up and drop-out.

With “easy” the circuit diagram is processed with a microprocessor that simulates the contacts and relays of the circuit concerned and thus processes all switching operations considerably faster. Depending on its size, the “easy” circuit diagram is processed cyclically every 4 to 40 ms.

During this time, “easy” passes through five segments in succession.

How “easy” evaluates the circuit diagram:

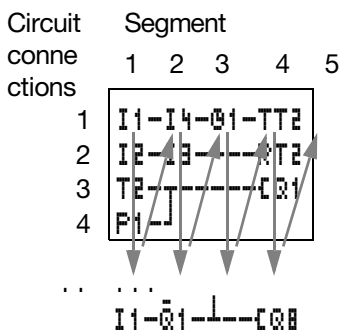

In the first three segments “easy” evaluates the contact fields in succession. As it does so, “easy” also checks whether contacts are connected in parallel or in series and stores the switching states of all the contact fields.

In the fourth segment, “easy” assigns the new switching states to all the coils in one pass.

The fifth segment is outside the circuit diagram. “easy” uses this to “make contact” with the outside world: Output relays Q1 to Q.. are switched and inputs I1 to I.. are read once more.

“easy” also copies all the new switching states to the status image register.

“easy” only uses this status image for one cycle. This ensures that each circuit connection is evaluated with the same switching states for one cycle, even if the input signals I1 to I12 change their status several times within a cycle.

How does this affect the creation of the circuit diagram?

“easy” evaluates the circuit diagram in these five segments in succession. You should therefore remember two points when you create your circuit diagrams:

The changeover of a relay coil does not change the switching state of an associated contact until the next cycle starts.

Always wire forward or from top to bottom. Never work backwards.

Example: Switching one cycle later

This is the circuit diagram of a self-latching circuit. If I1 and I2 are closed, the switching state of relay coil Q1 is “latched” via contact Q1.

Circuit diagram:

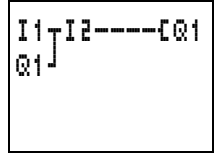

1st cycle: I1 and I2 are switched on. Coil Q1 picks up.

Start condition:
I1, I2 switched on
Q1 switched off.

Contact Q1 remains switched off since “easy” evaluates from left to right.

2nd cycle: The self-latching function now becomes active. “easy” has transferred the coil states to contact Q1 at the end of the first cycle.

Example: Do not wire backwards

This example is shown in chapter 5. It was used in the section „Creating and modifying connections“ to illustrate how NOT to do it.

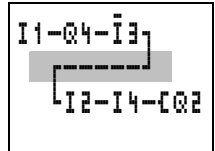

In the third circuit connection, “easy” finds a connection to the second circuit connection in which the first contact field is empty. The output relay is not switched.

When wiring more than three contacts in series, use one of the marker relays.

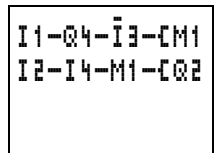

Determining the cycle time of “easy” circuit diagrams

The maximum cycle time of a circuit diagram must be known in order to determine the maximum counter frequency or reaction time of “easy”.

EASY412

For EASY412 the cycle time can be calculated as follows:

	Number	Time duration	Total
Basic pulse	1	210	–
Refresh	1	3500	–
Contacts and bridged contact fields	–	20	–
Coils	–	20	–
Circuit connections from the first one to the last one, with empty ones in between	–	50	–
Connecting lines (only T, L, F)	–	20	–
Timing relays (see Table 1)	–	–	–
Counters (see Table 1)	–	–	–
Analog value function relays (see Table 1)	–	–	–
Total			–

Table 1: List of times for processing function relays

Number	1	2	3	4	5	6	7	8
Timing relays in μs	20	40	80	120	160	200	240	280
Counters in μs	20	50	90	130	170	210	260	310
Analog value processors in μs	80	100	120	140	160	180	220	260

Example 1: parallel circuit

Calculation of the maximum cycle time for the following circuit diagram:



	Number	Time duration in μs	Total
Basic pulse	1	210	210
Refresh	1	3500	3500
Contacts and bridged contact fields	4	20	80
Coils	1	20	20
Circuit connections from the first one to the last one, with empty ones in between	2	50	100
Connecting lines (only \uparrow , \downarrow , \vdash)	–	20	–
Timing relays (see Table 1)	–	–	–
Counters (see Table 1)	–	–	–
Analog value function relays (see Table 1)	–	–	–
Total			3910

Example 2: Star/delta drive

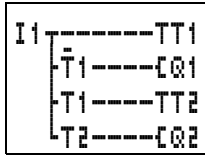

	Number	Time duration in μs	Total
Basic pulse	1	210	210
Refresh	1	3500	3500
Contacts and bridged contact fields	9	20	180
Coils	4	20	80
Circuit connections from the first one to the last one, with empty ones in between	4	50	200
Connecting lines (only L, L, L)	3	20	60
Timing relays (see Table 1)	2	40	40
Counters (see Table 1)	–	–	–
Analog value function relays (see Table 1)	–	–	–
Total			4270

Example 3: operating hours counter

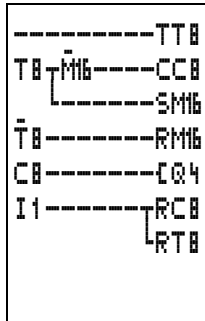

	Number	Time duration in μs	Total
Basic pulse	1	210	210
Refresh	1	3500	3500
Contacts and bridged contact fields	17	20	340
Coils	7	20	140
Circuit connections from the first one to the last one, with empty ones in between	7	50	350
Connecting lines (only L, L, †)	2	20	40
Timing relays (see Table 1)	1	20	20
Counters (see Table 1)	1	20	20
Analog (see Table 1)	–	–	–
Total			4620

EASY600

For EASY600 the cycle time can be calculated as follows:

	Number	Time duration in μs	Total
Basic pulse	1	520	–
Refresh	–	5700	–
Contacts and bridged contact fields	–	40	–
Coils	–	20	–
Circuit connections from the first one to the last one, with empty ones in between	–	70	–
Connecting lines (only \uparrow , \downarrow , \updownarrow)	–	40	–
Timing relays (see Table 2)	–	–	–
Counters (see Table 2)	–	–	–
Analog value function relays (see Table 2)	–	–	–
Total			–

Table 2: List of times for processing function relays

Number	1	2	3	4	5	6	7	8
Timing relays in μs	40	120	160	220	300	370	440	540
Counters in μs	40	100	160	230	300	380	460	560
Analog value processors in μs	120	180	220	260	300	360	420	500

Example: Operating hours counter

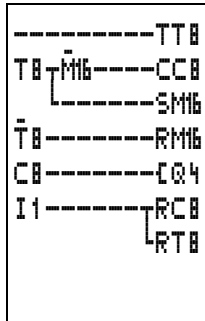

	Number	Time duration in μs	Total
Basic pulse	1	520	520
Refresh	–	5700	5700
Contacts and bridged contact fields	17	40	680
Coils	7	20	140
Circuit connections from the first one to the last one, with empty ones in between	7	70	490
Connecting lines (only \uparrow , \downarrow , \vdash)	2	40	180
Timing relays (see Table 2)	1	–	60
Counters (see Table 2)	1	–	40
Analog value function relays (see Table 2)	–	–	–
Total			7710

Delay times for inputs and outputs

The time from reading the inputs and outputs to switching contacts in the circuit diagram can be set in “easy” via the delay time.

This function is useful, for example, in order to ensure a clean switching signal despite contact bounce.

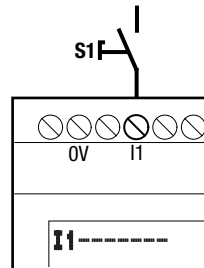

“easy”-DC, “easy”-DA and “easy”-AC units function with different input voltages and therefore also have different evaluation methods and delay times.

Debounce delay times for “easy”-DC basic units “easy”-DA

The debounce for DC signals is 20 ms.

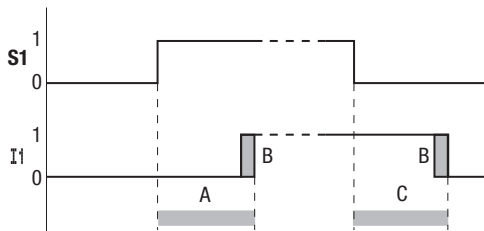

An input signal S1 must therefore be 15 V for at least 20 ms on the input terminal before the switch contact will change from 0 to 1 (A). If applicable, this time must also include the cycle time (B) since “easy” does not detect the signal until the start of a cycle.

The same debounce delay (C) applies when the signal drops out from 1 to 0.

If the debounce is switched off, “easy” responds to an input signal after just 0.25 ms.

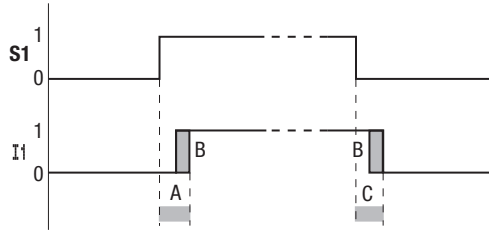

Typical delay times with the debounce delay switched off are:

On-delay for
I1 to I12: 0.25 ms

Off-delay for
I1 to I6 and I9 to I12: 0.4 ms
I7 and I8: 0.2 ms



Check that there is no interference affecting the input signals when the debounce delay is switched off. “easy” will respond even to very short signals.

Debounce delay times for “easy”-AC basic units

The input debounce with AC voltage signals depends on the frequency:

Switch-on delay
80 ms at 50 Hz, 66 ms at 60 Hz.

Off-delay for
I1 to I6 and I9 to I12: 80 ms (66 ms)
I7 and I8: 160 ms (150 ms) with EASY412-AC
I7 and I8: 80 ms (66 ms) with EASY6..-AC

The corresponding values for 60 Hz are given in brackets.

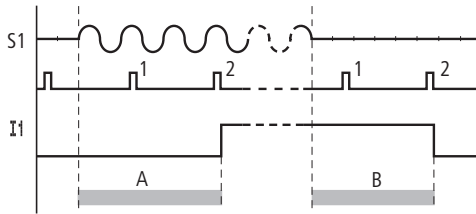

If the debounce delay is switched on, “easy” checks at 40 ms (33 ms) intervals whether there is a half-wave present at an input terminal (1st and 2nd pulses in A). If “easy” detects two pulses in succession, the device switches on the corresponding input internally.

If this is not the case, the input is switched off again as soon as “easy” does not detect two successive half-waves (1st and 2nd pulses in B).

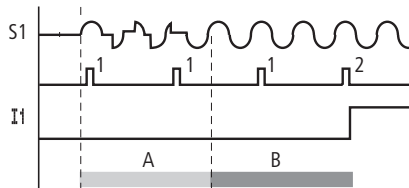

If a button or switch bounces (A), the delay time may be extended by 40 ms (33 ms) (A).

If the debounce delay is switched off, the delay time is reduced.

Switch-on delay
20 ms (16.6 ms)

Off-delay for
I1 to I6 and I9 to I12: 20 ms (16.6 ms)

Off-delay
I7 and I8: 100 ms (100 ms) with
EASY412-AC.

I7 and I8: 20 ms (16.6 ms) with EASY
EASY6..-AC-RC(X)

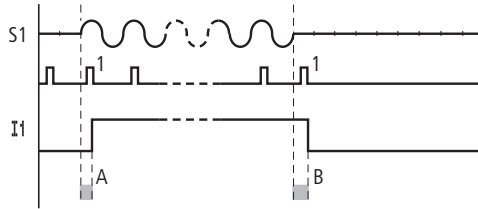

“easy” switches the contact as soon as it detects a pulse (A). If no pulse is detected, “easy” switches off the contact (B).



The procedure for changing the delay times is described in chapter 7 on page 145.

Monitoring for short-circuit/Overload with EASY..-D.-T..

Depending on the type of “easy” in use, it is possible to use the internal inputs I15 and I16, R15, R16 to monitor for short-circuits or overloads on an output.

EASY412-D.-T..:

I16 = Group fault signal for outputs Q1 to Q4.

EASY62 .-D.-T..:

I16 = Group fault signal for outputs Q1 to Q4.

I15 = Group fault signal for outputs Q5 to Q8.

EASY620-D.-TE:

R16 = Group fault signal for outputs S1 to S4.

R16 = Group fault signal for outputs S5 to S8.

State of outputs	Status I15 or I16, R15 or R16
No fault found	0 = switched off (make contact)
At least one output has a fault	1 = switched on (make contact)

Transfer EASY-D.-T.. → Memory card → EASY...-R...

I16 is added during transfer of the circuit diagram into “easy” from the memory card. I16 appears as I16 and the logical state remains 0 = switched off (make contact).

If I16 is changed in any way, only I1 to I8 can be entered. I16 can be deleted with the DEL button.

Transfer EASY-D.-T.. → EASY-SOFT (PC)

EASY-SOFT, Version 1.0, cannot process input I16. I16 is deleted during the transfer to EASY-SOFT. EASY-SOFT, Version 1.1, tolerates I16 without editing being possible. I16 is transferred when the circuit diagram is downloaded.

I16 should be evaluated in accordance with the individual application.



I15, I16 can only be edited with “easy” versions which have transistor outputs.

The following examples are for I16 = Q1 to Q4. I15 indicates in the same way short-circuits and overloads on Q5 to Q8.

Example 1: Output with fault indication

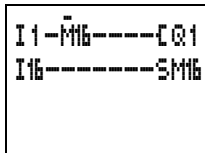

The above circuit diagram functions as follows:

If a transistor output reports a fault, M16 is set by I16. The break contact of M16 switches off output Q1. M16 can be cleared by resetting the “easy” power supply.

Example 2: Output of operating state

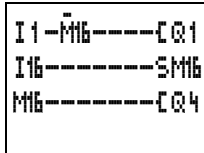

The above circuit functions as described in Example 1. An additional feature is that when an overload is detected the indicator light at Q4 is actuated. If Q4 has an overload, it would 'pulse'.

Example 3: Automatic reset of error signal

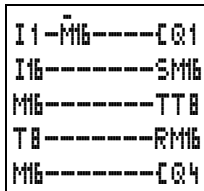

The above circuit diagram functions in the same way as Example 2. In addition the marker M16 is reset every 60 seconds by timing relay T8 (on-delayed, 60 s). Should I16 remain at 1, M16 will continue to be set. Q1 is set briefly to 1 until I16 switches off again.

Expanding EASY600

You can expand “easy” models EASY619/621-... locally using the expansion units EASY618-..-RE or EASY620-D.-TE or remotely – using the EASY200-EASY coupling module.

For this first install the units and connect the inputs and outputs (see chapter 3, Installation).

Incorporate the inputs of the expansion units as contacts in the “easy” circuit diagram like the inputs in the basic unit. The input contacts possible are R1 to R12.

R15, R16 are the group fault inputs of the transistor expansion unit (see also Monitoring Short-circuit/Overload on page 187).

The outputs are processed as relay coils or contacts like the outputs in the basic unit. The output relays are S1 to S8.



EASY618-..-RE provides the outputs S1 to S6. The other outputs S7, S8 can be used as markers.

How is an expansion unit recognised?

When at least one R contact or S contact/coil is used in the circuit diagram, the basic unit assumes that an expansion unit is connected.

Transfer behaviour

The input and output data of the expansion units is transferred serially in both directions. Take into account the modified reaction times of the inputs and outputs of the expansion units:

Input and output reaction times of expansion units

The debounce setting has no effect on the expansion unit.

Transfer times for input and output signals:

Local expansion

Time for inputs R1 to R12:

30 ms + 1 cycle

Time for outputs S1 to S6 (S8):

15 ms + 1 cycle time

Remote expansion

Time for inputs R1 to R12:

80 ms + 1 cycle

Time for outputs S1 to S6 (S8):

40 ms + 1 cycle time

Function monitoring of expansion units

If the power supply of the expansion unit is not present, no connection can be established between it and the basic unit. The expansion inputs R1 to R12, R15, R16 are incorrectly processed in the basic unit and show status 0. It cannot be assured that the outputs S1 to S8 are transferred to the expansion unit.



Warning

Ensure the continuous monitoring of the “easy” expansion in order to prevent switching faults in machines or systems.

The status of the internal input I14 of the basic unit indicates the status of the expansion unit:

I14 = 0: Expansion unit is functional

I14 = 1: Expansion unit is not functional

Example

Power can be applied to the expansion unit later than the basic unit. This therefore means that the basic unit is switched to Run with the expansion unit missing. The “easy” circuit diagram below detects if the expansion unit is operational or not.

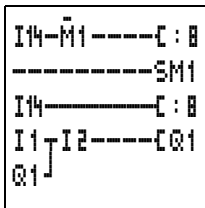

As long as I14 is 1, the remaining circuit diagram is skipped. If I14 is 0, the circuit diagram is processed. If the expansion unit drops out for any reason, the circuit diagram is skipped. M1 detects whether the circuit diagram was processed for at least one cycle after the power supply is switched on. If the circuit diagram is skipped, all the outputs retain their previous state. The next example should be used if this is not desired.

Example with LCD output and reset of the outputs

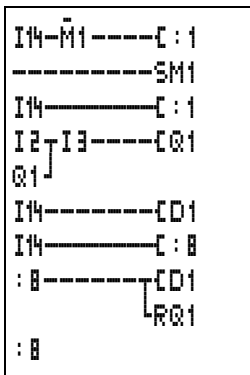

10 What Happens If ...?

You may sometimes find that “easy” does not do exactly what you expect. If this happens, read through the following notes which are intended to help you solve some of the problems you may encounter.

You can use the power flow display in “easy” to check the logic operations in the “easy” circuit diagrams with reference to the switching states of contacts and relays.

Only qualified persons should test “easy” voltages while the device is in operation.

What Happens If ...?

Message from the "easy" system

"easy" system messages on the LCD	Explanation	Remedy
No display	Power supply interrupted	Switch on the power supply
	"easy" LCD faulty	Replace "easy"
Continuous display		
"TEST: AC"	Self-test aborted	Replace "easy"
"TEST: EEPROM"		
"TEST: DISPLAY"		
"TEST: CLOCK"		
"ERROR: I2C"	Memory card removed or not inserted correctly before saving	Insert memory card
	Memory card faulty	Replace memory card
	"easy" is faulty	Replace "easy"
"ERROR: EEPROM"	The memory for storing the retentive values or the "easy" circuit diagram memory is faulty.	Replace "easy"
"ERROR: CLOCK"	Clock error	Replace "easy"
"ERROR: LCD"	LCD is faulty	Replace "easy"
"ERROR: ACLOW"	Incorrect AC voltage	Test the voltage
	"easy" is faulty	Replace "easy"

Possible situations when creating circuit diagrams

Possible situations when creating circuit diagrams	Explanation	Remedy
Cannot enter contact or relay in circuit diagram	"easy" is in Run mode	Select Stop mode
Time switch switches at wrong times	Incorrect time or time switch parameters	Check time and parameters
Cannot select analog comparator "Ax"	"easy" AC versions have no analog inputs	Use "easy"-DC, "easy"-DA for comparing analog values
Cannot select time switch contacts	"easy" has no clock	Use "easy"-C versions for time switch functions
When using a memory card "easy" will display the message "PROG INVALID"	"easy" memory card contains no circuit	Change the version of "easy" or change the circuit diagram on the memory card
	Circuit diagram on the memory card uses contacts/relays that "easy" does not – Use "easy"-C versions for time switch functions	
Current flow display does not show changes to the circuit connections	"easy" is in Stop mode	Select Run mode
	Operation / connection not performed	Check the circuit diagram and parameter sets and modify as required
	Relay does not activate coil	
	Incorrect parameter values / time – Analog value comparison is incorrect – Time value of timing relay is incorrect – Function of timing relay is incorrect	
Relay Q or M does not pick up	Relay coil has been wired up several times	Check coil field entries
Input not detected	Loose terminal contact	Check installation instructions, check external wiring
	No voltage to switch/button	
	Broken wire	
	"easy" input is faulty	Replace "easy"
Relay output Q does not switch and activate the load	"easy" in Stop mode	Select Run mode
	No voltage at relay contact	Check installation instructions, check external wiring
	"easy" power supply interrupted	
	"easy" circuit diagram does not activate relay output	
	Broken wire	
	"easy" relay is faulty	Replace "easy"

What Happens If ...?

Event

Event	Explanation	Remedy
The actual values are not being stored retentively.	Retention has not been switched on.	Switch on retention in the SYSTEM menu.
	EASY412-AC.. does not recognize the function.	Use EASY412-D.
	EASY412-DC.. does not recognize the function.	Use EASY412-D with retention
	The "easy" circuit diagram has been loaded with an EASY-SOFT version which does not support the function.	Switch on retention in the SYSTEM menu.
The RETENTION ON/OFF menu is not displayed in the SYSTEM menu.	This "easy" model does not have this function.	Use EASY412-D.
	"easy" is in Run mode	Stop mode
The SYSTEM menu is not displayed.	This "easy" model does not have this menu.	Exchange "easy" if you need retention
"easy" starts only in operating mode STOP	No circuit diagram in "easy"	Load, input circuit diagram
	Startup behaviour is set to the function "Startup in operating mode STOP".	Set the startup behaviour in the SYSTEM menu.
LCD display showing nothing	EASY412, EASY600 No power supply	Switch on the power supply
	"easy" is faulty	Press the cursor OK button. If no menu appears, replace the "easy".
	EASY600 Text displayed with too many spaces	Enter text or do not select

11 Technical Data

General

EASY...

	EASY200-EASY	EASY412	EASY600
Dimensions W × H × D			
[mm]	35.5 × 90 × 53	71.5 × 90 × 53	107.5 × 90 × 53
[inches]	1.4 × 3.54 × 2.08	2.81 × 3.54 × 2.08	4.23 × 3.54 × 2.08
Space units	2 space units wide	4 SU (space units) wide	6 SU (space units) wide
Weight			
[g]	70	200	300
[lb]	0.154	0.441	0.661
Mounting	DIN 50 022, 35 mm rail or screw mounting with 3 ZB-101-GF1 mounting feet (accessories); with EASY200-EASY only 2 mounting feet required.		

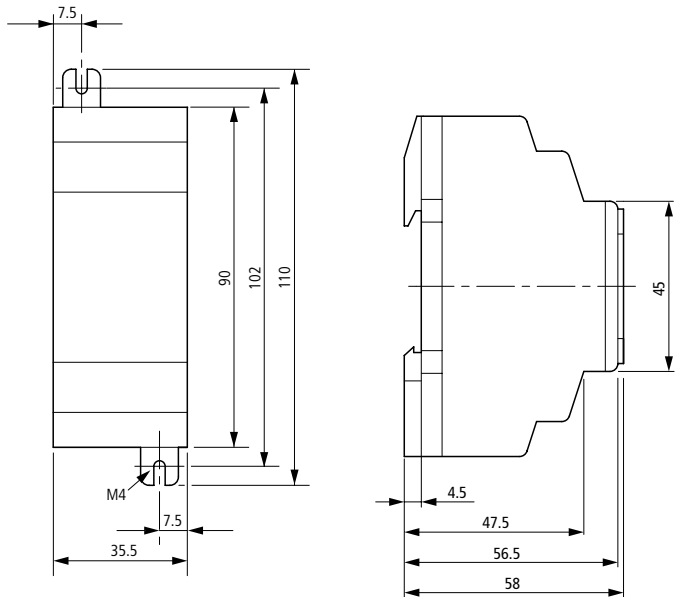

Figure 2: Dimensions of EASY200-EASY in mm (for dimensions in inches see Table 3)

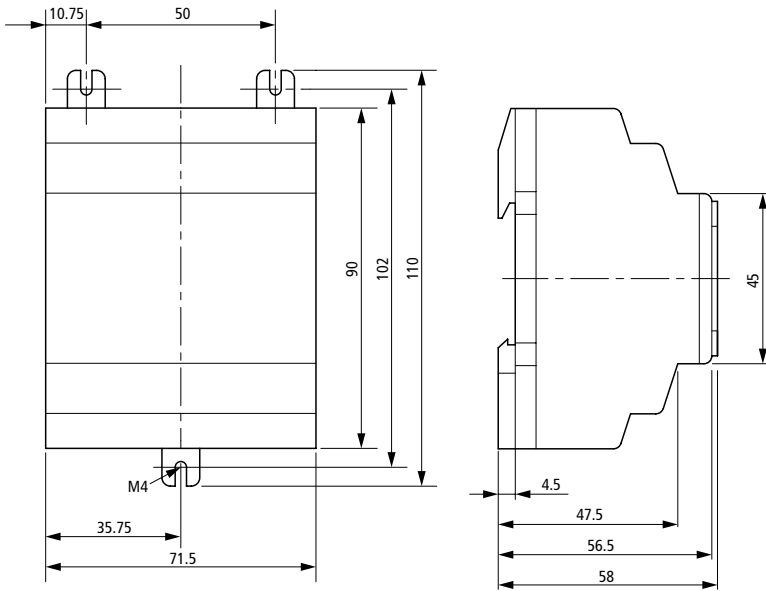

Figure 3: EASY412-... dimensions in mm
(for dimensions in inches see Table 3)

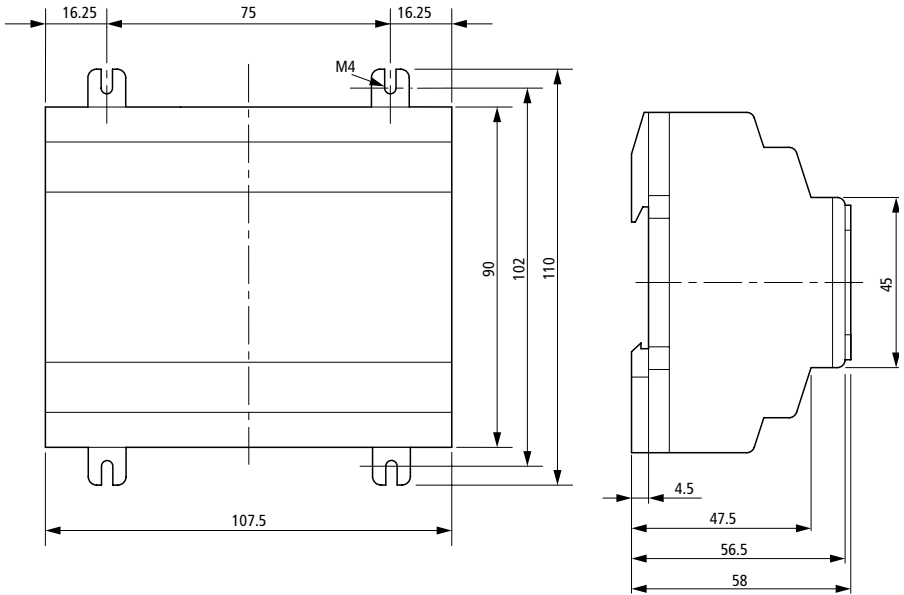

Figure 4: EASY600 dimensions in mm
(for dimensions in inches see Table 3)

Table 3: Dimensions in inches

mm	inches	mm	inches
4.5	0.177	56.5	2.22
7.5	0.295	58	2.28
10.75	4.23	71.5	2.81
16.25	0.64	75	2.95
35.5	1.4	90	3.54
35.75	1.41	102	4.01
45	1.77	107.5	4.23
47.5	1.87	110	4.33
50	1.97		

Technical Data

Ambient climatic conditions

(Cold to IEC 60 068-2-1, Heat to IEC 60 068-2-2)

Ambient temperature Installed horizontally/vertically	-25 to 55 °C, -13 to 131 °F
Condensation	Prevent condensation with suitable measures
LCD display (reliably legible)	0 to 55 °C, 32 to 131 °F
Storage/transport temperature	-40 to +70 °C, -40 to 158 °F
Relative humidity (IEC 60 068-2-30)	5 to 95 %, non-condensing
Air pressure (operation)	795 to 1080 hPa
Corrosion resistance	
IEC 60 068-2-42	SO ₂ 10 cm ³ /m ³ , 4 days
IEC 60 068-2-43	H ₂ S 1 cm ³ /m ³ , 4 days

Ambient mechanical conditions

Pollution degree	2
Degree of protection (EN 50 178, IEC 60 529, VBG4)	IP 20
Oscillations (IEC 60 068-2-6)	10 to 57 Hz (constant amplitude 0.15 mm) 57 to 150 Hz (constant acceleration 2 g)
Shock (IEC 60 068-2-27)	18 shocks (semi-sinusoidal 15 g/11 ms)
Drop (IEC 60 068-2-31)	Drop height 50 mm
Free fall, when packed (IEC 60 068-2-32)	1 m

Electromagnetic compatibility (EMC)

Electrostatic discharge (ESD), (IEC/EN 61 000-4-2, severity level 3)	8 kV air discharge, 6 kV contact discharge
Electromagnetic fields (RFI), (IEC/EN 61 000-4-3)	Field strength 10 V/m
Radio interference suppression (EN 55 011, EN 55 022)	Class B
Burst (IEC/EN 61 000-4-4, severity level 3)	2 kV power cables, 2 kV signal cables
High-energy pulses (surge) "easy"-AC (IEC/EN 61 000-4-5)	2 kV power cable symmetrical
High-energy pulses (surge) "easy"-DC (IEC/EN 61 000-4-5, severity level 2)	0.5 kV power cable symmetrical
Line-conducted interference (IEC/EN 61 000-4-6)	10 V

Dielectric strength

Measurement of the air clearance and creepage distance	EN 50 178, UL 508, CSA C22.2, No 142
Dielectric strength	EN 50 178

Tools and cable cross-sections

Solid	min. 0.2 mm ² , max. 4 mm ² /AWG: 22 – 12
Flexible with ferrule	min. 0.2 mm ² , max. 2.5 mm ² / AWG: 22 – 12 Factory wiring: up to AWG 30
Slot-head screwdriver, width	3.5 × 0.8 mm, 0.14 × 0.03"
Tightening torque	0.6 Nm

Backup/accuracy of real-time clock (only with "easy"-C)

Clock battery back-up	
at 25 °C/77 °F	Normally 64 h
at 40 °C/104 °F	Normally 24 h
Accuracy of the real-time clock	Normally ± 5 s/day, ~ ± 0.5 h/year

Repetition accuracy of timing relays

Accuracy of timing relays	± 1 % of value
Resolution	
Range "s"	10 ms
Range "M:S"	1 s
Range "H:M"	1 min.

Retentive memory

Write cycles of the retentive memory	≧ 100 000
--------------------------------------	-----------

Circuit connections (basic units)

EASY412	41
EASY600	121

Power supply EASY412-AC-..., EASY61.-AC-R..

	EASY412-AC-...	EASY61.-AC-R..
Rated value (sinusoidal)	115/120/230/240 V AC	100/110/115/120/230/240 V AC
Operating range	+10/-15 % 90 to 264 V AC	+10/-15 % 85 to 264 V AC
Frequency, rated value, tolerance	50/60 Hz, ± 5 %	50/60 Hz, ± 5 %
Input current consumption		
at 115/120 V AC 60 Hz	Normally 40 mA	Normally 70 mA
at 230/240 V AC 50 Hz	Normally 20 mA	Normally 35 mA
Voltage dips	20 ms, EN 61131-2	20 ms, EN 61131-2
Power loss		
at 115/120 V AC	Normally 5 VA	Normally 10 VA
at 230/240 V AC	Normally 5 VA	Normally 10 VA

**EASY412-DA-..., EASY412-DC-...,
EASY61.-DC-R.., EASY62.-DC-T..**

	EASY412-DA-...	EASY412-DC-...	EASY61.-DC-R.., EASY62.-DC-T..
Rated voltage			
Rated value	12 V DC, +30 %, -15 %	24 V DC, +20 %, -15 %	
Permissible range	10.2 to 15.6 V DC	20.4 to 28.8	20.4 to 28.8
Residual ripple	± 5 %	≤ 5 %	≤ 5 %
Input current at 24 V DC (with EASY412-DA-... 12 V DC)	Normally 140 mA	Normally 80 mA	Normally 140 mA
Voltage dips	10 ms, EN 61131-2		
Power dissipation at 24 V DC (with EASY412-DA-... 12 V DC)	Normally 2 W	Normally 2 W	Normally 3,5 W

Inputs**EASY-412-AC-..., EASY61.-AC-R..**

	EASY-412-AC-...	EASY61.-AC-R..
Digital inputs 115/230 V AC		
Number	8	12
Status display	LCD (if provided)	LCD (if provided)
Electrical isolation		
To power supply	No	No
Between each other	No	No
To the outputs	Yes	Yes
Rated voltage L (sinusoidal)		
0 signal	0 to 40 V AC	0 to 40 V AC
1 signal	79 to 264 V AC	79 to 264 V AC
Rated frequency	50/60 Hz	50/60 Hz
Input current with 1 signal R1 to R12, I1 to I6 (EASY61. also I9 to I12)	6 × 0.5 mA at 230 V AC 50 Hz, 6 × 0.25 mA at 115 V AC 60 Hz	10 (12) × 0.5 mA at 230 V AC, 50 Hz 10 (12) × 0.25 mA at 115 V AC, 60 Hz
Input current on 1 signal I7, I8	2 × 6 mA at 230 V AC 50 Hz, 2 × 4 mA at 115 V AC 60 Hz	2 × 6 mA at 230 V AC 50 Hz, 2 × 4 mA at 115 V AC 60 Hz
Delay time for 0 to 1 and 1 to 0 for I1 to I6, I9 to I12		
Debounce ON	80 ms (50 Hz), 66 ² / ₃ ms (60 Hz)	80 ms (50 Hz), 66 ² / ₃ ms (60 Hz)
Debounce OFF (also R1 to R12)	20 ms (50 Hz), 16 ² / ₃ ms (60 Hz)	20 ms (50 Hz), 16 ² / ₃ ms (60 Hz)
Delay time I7, I8 for 1 to 0		
Debounce ON	160 ms (50 Hz), 150 ms (60 Hz)	80 ms (50 Hz), 66 ² / ₃ ms (60 Hz)
Debounce OFF	100 ms (50 Hz/60 Hz)	20 ms (50 Hz), 16 ² / ₃ ms (60 Hz)
Delay time I7, I8 for 0 to 1		
Debounce ON	80 ms (50 Hz), 66 ² / ₃ ms (60 Hz)	80 ms (50 Hz), 66 ² / ₃ ms (60 Hz)
Debounce OFF	20 ms (50 Hz), 16 ² / ₃ ms (60 Hz)	20 ms (50 Hz), 16 ² / ₃ ms (60 Hz)
Max. permissible cable length (per input)		
I1 to I6, R1 to R12 (with EASY61. also I9 to I12)	Normally 40 m	Normally 40 m
I7, I8	Normally 100 m	Normally 100 m

EASY412-DA-..., EASY412-DC-..., EASY6..-DC-...

	EASY412-DA-...	EASY412-DC-...	EASY6..-DC-...
Digital inputs			
Number	8	8	12
	2 inputs (I7, I8) usable as analog inputs		
Status display	LCD (if provided)		
Electrical isolation			
To power supply	No	No	No
Between each other	No	No	No
To the outputs	Yes	Yes	Yes
Rated voltage			
Rated value	12 V DC	24 V DC	24 V DC
0 signal	< 4 V DC (I1 to I8)	< 5 V DC (I1 to I8)	< 5 V DC (I1 to I12, R1 to R12)
1 signal	> 8 V DC (I1 to I8)	> 8 V DC (I7, I8) > 15 V DC (I1 to I6)	> 8 V DC (I7, I8) > 15 V DC (I1 to I6, I9 to I12, R1 to R12)
Input current on 1 signal	3.3 mA at 12 V DC (I1 to I6)	3.3 mA at 24 V DC (I1 to I6, R1 to R12)	3.3 mA at 24 V DC (I1 to I6, I9 to I12, R1 to R12)
I7, I8	1.1 mA at 12 V DC	2.2 mA at 24 V DC	2.2 mA at 24 V DC
Delay time for 0 to 1			
Debounce ON	20 ms	20 ms	20 ms
Debounce OFF	Normally 0.3 ms (I1 to I6)	Normally 0.25 ms (I1 to I12)	
Delay time for 1 to 0			
Debounce ON	20 ms	20 ms	20 ms
Debounce OFF (with EASY412-DC-... and EASY6..-DC-... also R1 to R12)	Normally 0.3 ms (I1 to I6) Normally 0.15 ms (I7,	Normally 0.4 ms (I1 to I6) Normally 0.2 ms (I7,	Normally 0.4 ms (I1 to I6, I9 to I12) Normally 0.2 ms (I7,
Cable length (unshielded)	100 m	100 m	100 m

	EASY412-D-...	EASY6..-DC-...
Analog inputs		
Number	2	2
Electrical isolation		
To power supply	No	No
To the digital inputs	No	No
To the outputs	Yes	Yes
Input type	DC voltage	DC voltage
Signal range	0 to 10 V DC	0 to 10 V DC
Resolution analog	0.1 V	0.1 V
Resolution digital	0.1	0.1
Input impedance	11.2 k Ω	11.2 k Ω
Accuracy of		
Two "easy" devices	$\pm 3\%$ of actual value	$\pm 3\%$ of actual value
within a single device	$\pm 2\%$ of actual value (I7, I8), ± 0.12 V	
Conversion time, analog/digital	Debounce ON: 20 ms Debounce OFF: Each cycle time	
Input current	< 1 mA	< 1 mA
Cable length (shielded)	30 m	30 m

Relay outputs **EASY412-...-R..., EASY618/619...**

	EASY412-...-R...	EASY618/619...
Number	4	6
Type of outputs	Relay	Relay
In groups of	1	1
Connection of outputs in parallel to increase the output	Not permissible	Not permissible
Protection for an output relay	Miniature circuit-breaker B16 or 8 A fuse (slow)	
Potential isolation to mains supply, inputs	Yes 300 V AC (safe isolation) 600 V AC (basic isolation)	Yes 300 V AC (safe isolation) 600 V AC (basic isolation)
Mechanical lifespan (switching cycles)	10×10^6	10×10^6
Contacts relays		
Conventional thermal current	8 A (10 A UL)	8 A (10 A UL)
Recommended for load	> 500 mA, 12 V AC/DC	> 500 mA, 12 V AC/DC
Protected against short-circuit $\cos \varphi = 1$	16 A characteristic B (B16) at 600 A	
Protected against short-circuit $\cos \varphi = 0.5$ to 0.7	16 A characteristic B (B16) at 900 A	
Rated impulse withstand voltage U_{imp} contact coil	6 kV	6 kV
Rated insulation voltage U_i		
Rated operational voltage U_e	250 V AC	250 V AC
Safe isolation to EN 50 178 between coil and contact	300 V AC	300 V AC
Safe isolation to EN 50 178 between two contacts	300 V AC	300 V AC
Making capacity		
AC-15 250 V AC, 3 A (600 Ops/h)	300 000 switching operations	300 000 switching operations
DC-13 L/R ≤ 150 ms 24 V DC, 1 A (500 Ops/h)	200 000 switching operations	200 000 switching operations
Breaking capacity		
AC-15 250 V AC, 3 A (600 Ops/h)	300 000 switching operations	300 000 switching operations
DC-13 L/R ≤ 150 ms 24 V DC, 1 A (500 Ops/h)	200 000 switching operations	200 000 switching operations

Relay outputs

	EASY412-...-R...	EASY618/619...
Filament lamp load	1000 W at 230/240 V AC/25 000 operations 500 W at 115/120 V AC/25 000 operations	
Fluorescent tube with ballast	10 × 58 W at 230/240 V AC/25 000 operations	
Conventional fluorescent tube, compensated	1 × 58 W at 230/240 V AC/25 000 operations	
Fluorescent tube, uncompensated	10 × 58 W at 230/240 V AC/25 000 operations	
Operating frequency, relays		
Mechanical switching operations	10 million (10 ⁷)	10 million (10 ⁷)
Mechanical switching frequency	10 Hz	10 Hz
Resistive lamp load	2 Hz	2 Hz
Inductive load	0.5 Hz	0.5 Hz

UL/CSA

Uninterrupted current at 240 V AC/24 V DC		10/8 A
AC	Control Circuit Rating Codes (Utilization category)	B300 Light Pilot Duty
	Max. rated operational voltage	300 V AC
	Max. thermal uninterrupted current cos φ = 1 at B300	5 A
	Maximum make/break capacity cos φ ≠ 1 (Make/break) at B300	3600/360 VA
DC	Control Circuit Rating Codes (Utilization category)	R300 Light Pilot Duty
	Max. rated operational voltage	300 V DC
	Max. thermal uninterrupted current at R300	1 A
	Maximum make/break capacity at R300	28/28 VA

Transistor outputs **EASY-412-D.-T..., EASY62...**

	EASY412-D.-T...	EASY62...
Number of outputs	4	8
Contacts	Semiconductors	Semiconductors
Rated voltage U_e	24 V DC	24 V DC
Permissible range	20.4 to 28.8 V DC	20.4 to 28.8 V DC
Residual ripple	$\leq 5 \%$	$\leq 5 \%$
Supply current		
0 signal	Normally 9 mA, max. 16 mA	Normally 18 mA, max. 32 mA
1 signal	Normally 12 mA, max. 22 mA	Normally 24 mA, max. 44 mA
Reverse polarity protection	Yes, caution! If voltage is applied to the outputs when the polarity of the power supply is reversed, this will result in a short circuit.	
Potential isolation to mains supply, inputs	Yes	Yes
Rated current I_e for 1 signal	max. 0.5 A DC	max. 0.5 A DC
Lamp load	5 watts without R_V	5 watts without R_V
Residual current at state "0" per channel	< 0.1 mA	< 0.1 mA
Max. output voltage		
0 signal with ext. load < 10 M Ω	2.5 V	2.5 V
1 when $I_e = 0.5$ A	$U = U_e - 1$ V	$U = U_e - 1$ V
Short-circuit protection	Yes, thermal (detected via diagnostics input I16, I15; R15;R16)	
Short-circuit tripping current for $R_a \leq 10$ m Ω	0.7 A $\leq I_e \leq 2$ A (depending on number of active channels and their load)	
Max. total short-circuit current	8 A	16 A
Peak short-circuit current	16 A	32 A
Thermal cutout	Yes	Yes
Maximum switching frequency with constant resistive load $R_L < 100$ k Ω : switching operations pro hour	40 000 (depends on circuit diagram and load)	
Parallel connection of outputs with resistive load; inductive load with external suppression circuit (see page 43) combination within a group	Group 1: Q1 to Q4	Group 1: Q1 to Q4, S1 to S4 Group 2: Q5 to Q8, S5 to S8
Number of outputs	max. 4	max. 4
Total maximum current	2.0 A, caution! Outputs must be actuated simultaneously and for the same time duration.	
Status display of the outputs	LCD display (if provided)	

Inductive load (without external suppressor circuit)

General explanations:

$T_{0.95}$ = time in msec. until 95 % of the stationary current is reached

$$T_{0.95} \approx 3 \times T_{0.65} = 3 \times \frac{L}{R}$$

Utilization category Q1 to Q4

$T_{0.95} = 1 \text{ ms}$ $R = 48 \Omega$ $L = 16 \text{ mH}$	Utilization factor	$g = 0.25$
	Rel. duty factor	100%
	Max. switching frequency Max. duty factor => switching cycles per hour	$f = 0.5 \text{ Hz}$ DF = 50 % 1500
DC13 $T_{0.95} = 72 \text{ ms}$ $R = 48 \Omega$ $L = 1.15 \text{ H}$	Utilization factor	$g = 0.25$
	Rel. duty factor	100%
	Max. switching frequency Max. duty factor => switching cycles per hour	$f = 0.5 \text{ Hz}$ DF = 50 % 1500

Other inductive loads:

$T_{0.95} = 15 \text{ ms}$ $R = 48 \Omega$ $L = 0.24 \text{ H}$	Utilization factor	$g = 0.25$
	Rel. duty factor	100%
	Max. switching frequency Max. duty factor => switching cycles per hour	$f = 0.5 \text{ Hz}$ DF = 50 % 1500

Inductive load with external suppressor circuit for each load (see section "Connecting transistor outputs" on page 41)

	Utilization factor	$g = 1$
	Rel. duty factor	100%
	Max. switching frequency Max. duty factor => switching cycles per hour	Depends on the suppressor circuit

Cycle time

EASY412-...

	Number	Time duration in μs	Total
Basic pulse	1	210	
Refresh	1	3500	
Contacts and bridged contact fields		22, 23	
Coils		22, 23	
Circuit connections from the first one to the last one, with empty ones in between		50	
Connecting lines (only $\uparrow, \downarrow, \updownarrow$)		22, 23	
Timing relays (see Table 4)		–	
Counters (see Table 4)		–	
Analog value function relays (see Table 4)		–	
Total			

Table 4: List of times for processing function relays

Number	1	2	3	4	5	6	7	8
Timing relays in μs	22,	40	80	120	160	200	240	280
Counters in μs	22,	50	90	130	170	210	260	310
Analog value comparators in μs	80	100	120	140	160	180	220	260

EASY600

	Number	Time duration in μs	Total
Basic pulse	1	520	
Refresh		5700	
Contacts and bridged contact fields		40	
Coils		22, 23	
Circuit connections from the first one to the last one, with empty ones in between		70	
Connecting lines (only \uparrow , \downarrow , \vdash)		40	
Timing relays (see Table 5)		–	
Counters (see Table 5)		–	
Analog value function relays (see Table 5)		–	
Total			

Table 5: List of times for processing function relays

Number	1	2	3	4	5	6	7	8
Timing relays in μs	40	120	160	220	300	370	440	540
Counters in μs	40	100	160	230	300	380	460	560
Analog value comparators in μs	120	180	220	260	300	360	420	500

Glossary

Analog input	The DC versions of “easy” have analog inputs I7 and I8. The input voltage range is 0 V to 10 V. Input data is evaluated by built-in analog comparator function relays.
Circuit connections	Each line in the circuit diagram display is a circuit connection (EASY412: 41 circuit connections, EASY600: 121 circuit connections).
Circuit diagram symbols	As in conventional wiring, the circuit diagram is made up of circuit elements. These include input, output and marker relays, plus function relays and the P buttons.
Connect mode	Connect mode is used to wire up the circuit elements in your “easy” circuit diagram.
Contact behaviour	The contact behaviour of any circuit element can be defined as either a break contact or a make contact. Break contact elements are identified by a line on top of the identifier (Exception: Jump).
Entry mode	Entry mode is used to input or modify values when creating circuit diagrams or setting parameters, for example.
Function relays	Function relays are provided for more complex switching tasks. “easy” features the following types of relay:

Timing relays
Time switches
Counters
Analog comparators
Text marker relays

Impulse relay

An impulse relay is a relay which changes its switching state and stays changed (latched) when a voltage is applied to the relay coil for a short time.

Input

The inputs are used to connect up external contacts. In the circuit diagram, inputs are evaluated via contacts I1 to I12 and R1 to R12.

“easy” 24 V DC can also receive analog data via inputs I7 and I8.

Interface

The “easy” interface is used to exchange and save circuit diagrams to a memory card or PC.

Each memory card contains one circuit diagram and its associated “easy” settings.

The EASY-SOFT PC software allows you to control “easy” from your PC which is connected using the “easy-PC-CAB” cable.

Local expansion

I/O expansion with the expansion unit (e.g. EASY620-DC-TE) installed directly on the basic unit. The connector is always supplied with the expansion unit.

Memory card

The memory card is used to store your “easy” circuit diagram, together with its parameter and “easy” settings. Your data on the memory card will be

retained, even if the power supply fails or is switched off.

The memory card is inserted into the interface slot on the “easy” device.

Operating buttons

“easy” has eight operating buttons. These are used to select menu functions and create circuit diagrams. The large round button in the middle is used to move the cursor.

DEL, **ALT**, **ESC** and **OK** all perform additional functions.

Operating mode

“easy” has two operating modes: RUN and STOP. RUN mode is used to process your circuit diagram (with the controller running continuously). In STOP mode you can create your circuit diagrams.

Output

You can connect various loads to the four “easy” outputs, such as contactors, lamps or and motors. In the “easy” circuit diagram the outputs are controlled via the corresponding output relay coils Q1 to Q8 or S1 to S8 (Q6).

P buttons

The P buttons can be used to simulate four additional inputs which are controlled directly by the four cursor buttons, rather than via external contacts. The relay contacts of P buttons are connected up in the circuit diagram.

Parameters

Parameters enable the user to set the behaviour of a function relay. Possible values include switching times or counter setpoints. They are set in the parameter display.

Power supply

“easy”-AC is powered by AC voltage at 115 to 240 V AC, 50/60 Hz. The terminals are labelled “L” and “N”. “easy”-DC is powered by DC voltage at 24 V DC. The terminals are labelled “+24 V” and “0 V”.

The terminals for the power feed are the first three terminals on the input side.

Remote expansion

I/O expansion with the expansion unit (e.g. EASY620-DC-TE) installed up to 30 m away from the basic unit. The EASY200-EASY coupling unit is fitted to the basic unit. The input and output data is exchanged between expansion and basic unit via a two-wire cable.

Retention

Retentive data is kept even after the “easy” power supply is switched off.

The following data is retentive:

- “easy” circuit diagram
- Parameters, setpoint values
- Texts
- System settings
- Password entry
- Actual values of marker relays, timing relays, counters

Index

Symbols

“easy” basic units at a glance 10

A

Accuracy
 Analog comparators 100
Actual values 78
Analog comparators
 Hysteresis 100
 Parameter sets 102
AND circuit 109

B

Basic circuit
 Changeover circuit 110
 Latching circuit 111
 Negation 109
 Parallel connection 110
 Permanent contact 109
 Series connection 109
Break contact 61
 Inverting 67
Button 12
 ALT 53
 DEL 54
 OK 51, 60

C

Cable lengths 30
Cable protection 28
Change menu level 51
Changing to summer time 144
Changing to winter time 144
Circuit connection
 Delete 70
 Inserting 69
 Number 63
Circuit connections
 Inserting new connections 53

Circuit diagram	
Checking	72
Circuit connection	62
Coil field	62
Contact fields	62
Delete	56
Examples	108
Fast entry	57
Grid lines	51, 62
Internal processing	175
Loading	130
Operating buttons	60
Overview	62
Saving	130
Storing	127
Testing	55
Wiring	53, 67
Circuit diagram display	51, 62
Coil field	62
Coil function	
Contactor	74
Impulse relay	75
Latching relay	76
Comparing analog values	98
Connecting	
20 mA sensors	38
Analog inputs	35
Contactors, relays	39
Light intensity sensors	37
Neon bulbs	31
Proximity switches	34
Push-button actuators	34
Push-button actuators, switches	30
Relay outputs	39
Setpoint potentiometers	36
Temperature sensors	38
Transistor outputs	41
Connections	
Delete	68
Entering	67
Position in circuit diagram	62
Contact fields	62

Contacts	67
Changing	65
Contact name	65
Contact number	65
Cursor buttons	70
Delete	67
Entering	52, 65
Inverting	53
Overview	61
Counter relays	90
Parameter set	92
Cursor display	19, 60
Cycle	175

D

Debounce (input delay)	
Setting	145
Debounce delay times	
For “easy”-AC	185
For “easy”-DA	184
For “easy”-DC	184
Deleting retentive actual values	153
Determining counter frequency	92
Determining the cycle time	177
Dimensions, “easy”	197

E

Error handling	193
Examples	
Impulse relay	158
S/R coil (break contact)	156
S/R function	160
Timing relay, off-delayed	166
Timing relay, on-delayed	163
Timing relay, single-pulse	168

F

Flicker effect	156
Function relay	
Counter relays	90
Example	78
Overview	77

Time switches	93
Timing relay	84
H	
Hysteresis	
Analog comparators	100
I	
Impulse	158
Impulse relay	75
Increasing the input current	32
Input contacts	65
Inserting	
Circuit connections	53
Contact	52
Interface	125
Interference	30
Inverting	67
J	
Jumps	105
L	
Latching	74
Latching circuit	111
Latching relay	76
LED	15
Logic tables	108–111
M	
Main menu	
Overview	16
Selecting	13
Make contact	61
Inverting	67
Marker relays	73, 177
Markers	73
Retentive	156
Memory card	
Deleting	129
Inserting	127
Menu guidance	12

Menu options	
Toggling between	55
Message	
INVALID PROG	195
PROG INVALID	129, 131
System	194
Mounting	
Screw fixing	23
Top-hat rail	22
Mounting feet	23
N	
NAND circuit	110
Neon bulbs	31
NOT circuit	109
O	
Operating buttons	12
Operating mode	
Changing	55
OR circuit	110
Output relays	65
Overload	43
Monitoring with EASY...-D.-T..	187
P	
P buttons	70
Activating and deactivating	146
Parameter	
Power flow display	83
Parameter access	
Analog comparators	102
Counter relays	92
Time switch	97
Timing relays	85
Parameters	
Changing	140
Changing the switching time	142
Disable access	140
Display	140
Password	
Activating	135
Changing	137

Deleting	137
Removing protection	138
Setting	134
Unlocking "easy"	136
PC connection	130
Power failure	48
Power flow display	56, 71, 72, 83

R

Reed relay contacts	31
Relay	
Name	65
Number	65
Overview	62, 73
Relay coil	
Changing	65
Coil function	65
Coil functions	73
Delete	67
Entering	54, 65
Reset	76
Restricting the inrush current	32
Retention	
Setting	152
Retention requirements	
Permitted "easy" models	151
Permitted markers and function relays	151
Retentive behaviour	154
Transfer of circuit diagrams	154
RUN, Startup behaviour	48
RUN/STOP changeover	55

S

Screw fixing	23
Set	76
Setpoints	78, 141
Setting the clock	143
Setting the menu language	47, 139
Setting the weekday	143
Short-circuit	43
Monitoring with EASY..-D.-T..	187
Signal	75

Startup behaviour	147
After deleting the circuit diagram	149
Default setting	148
Possible faults	149
Setting	147
Upload/Download to card or PC	149
Status display	14
Status image	176
Suppressing contact bounce	184
System menu	17, 18
Selecting	13

T

Text display	103
Time switch	
Examples	94
Parameter set	97
Timing relay	
Flashing	89
Off-delayed	87
On-delayed	86
Parameter set	85
Retentive	161
Single pulse	88
Wiring	84
Torque	25
Transfer cable	130
Two-wire proximity switches	32
Type overview	12

W

Wiring	
Backwards	177
Delete	54
Entering	53
Relay coils	74
Rules	74

X

XOR circuit	110
-------------------	-----

“easy” Control Relay Circuit Diagram

FO 98















Customer: _____

Program: _____

Date: _____

Page: _____

Comment:

	_____
	_____
	_____
	_____
	_____
	_____
	_____
	_____
	_____
	_____
	_____
	_____
	_____
	_____

“easy” Control Relay Circuit Diagram

FO 98

Customer: _____ Program: _____

Date: _____ Page: _____

Timing relays

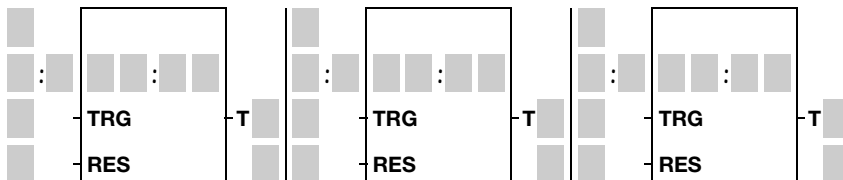

Analog comparators

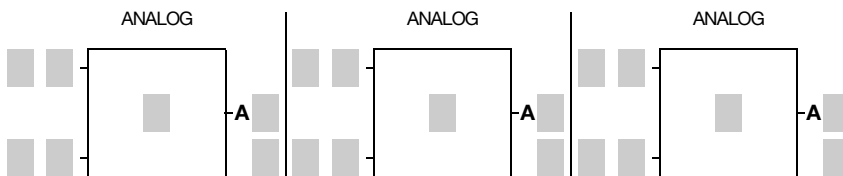

Timing switches

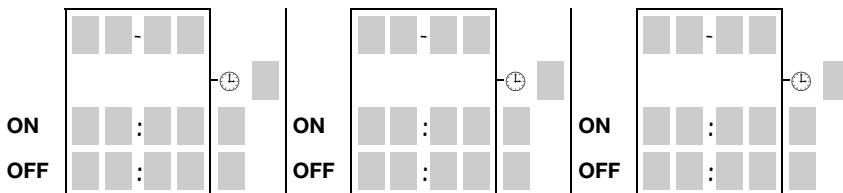

Up/down counters

