

## MICRO SWITCH Miniature Military-Grade Toggle Switch

TW Series

**005431**

Issue 3

**Datasheet**



### DESCRIPTION

Honeywell MICRO SWITCH TW Series toggle switches are military qualified to MIL-83731 specifications for sealed and unsealed toggle switches. Quality construction features include an available bonded seal between the toggle lever and bushing for those applications where a sealing-related failure cannot be tolerated.

The durable design of the TW Series toggle is well-suited for many military, aerospace and other demanding applications where space behind the panel is limited. These applications include environments where the panels are subjected to mechanical shock, vibration, dust, splashing or hose-directed water, and temperature extremes.

MICRO SWITCH TW toggles feature a miniature military-grade design with environmental sealing capabilities and can be configured with a large selection of circuitries, electrical terminations, lever and bushing designs, and contact material options to satisfy a diverse range of applications.

### VALUE TO CUSTOMERS

- MIL-DTL-83731 qualified switches available to meet military specifications
- Environmental sealing availability enables switches to withstand many demanding indoor and outdoor applications
- Miniature size (small footprint) for applications where behind-the-panel space is at a minimum
- 2- and 3-position, maintained and momentary toggle action to meet circuit and actuator requirements

### FEATURES

- MIL-DTL-83731 qualified switches are available to meet military/aerospace specifications
- 1- and 2- pole options along with 2- and 3-position, maintained and momentary toggle action
- Wide temperature range: -65 °C to 71 °C [-85 °F to 160 °F]
- 1/4 in and 15/32 in bushing diameters
- Standard, locking, & colored paddle levers
- Optional lever locks (pull-to-unlock) require two separate actions to actuate
- Three popular termination options: screw, solder, and IWTS (Integrated Wire Termination System)
- Silver alloy or gold-plated contacts
- Electrical endurance of 20,000 cycles at full load

### POTENTIAL INDUSTRIAL APPLICATIONS

- Military and commercial aircraft and helicopters
- Aviation ground support equipment
- Military land vehicles (track and wheeled vehicles)
- Industrial machinery and construction equipment
- Process control

### DIFFERENTIATION

- Miniature size saves space and weight
- Variety of terminations, circuitries, and lever options for a number of applications

### PORTFOLIO

In addition to the TW Series, Honeywell offers six series of MICRO SWITCH toggle switches including the [TL Series](#), [NT Series](#), [TS Series](#), [ET Series](#), and [AT Series](#).

# MICRO SWITCH Miniature Military-Grade Toggle Switch, TW Series

**Table 1. Specifications**

Characteristic	Parameter
Description	miniature military-grade toggle switch
Sealing	qualified to MIL-DTL-83731
Operating temperature	-65 °C to 71 °C [-85 °F to 160 °F]
Actuators	standard, locking, special design, paddle
Action	2- or 3- position; momentary and maintained
Mounting	bushing 15/32 in (0.47 in) Ø; 1/4 in (0.25 in) Ø
Circuitry	SPDT, DPDT, SPST, DPST
Terminations	IWTS, solder (T and T2), quick connect (H58)
Contacts	fine silver or gold-plated
Amp rating	0.1 A to 5.0 A @ 0.5 Vdc to 28 Vdc 0.1 A to 5.0 A @ 0.5 Vac to 115 Vac
Approvals	UL, qualified to MIL-DTL-83781
Measurement	49,78 mm H x 14,61 mm W x 14,61 mm D [1.96 in H x 0.575 in W x 0.575 in D]

**Table 2. Electrical Ratings (in amperes)**

Volts	Resistive	Inductive	Lamp
30 Vdc	5	2	1
115 Vac	5	2	1
UL Code 117	5 A @ 125 Vac		

## TERMINAL CIRCUIT IDENTIFICATION

Terminal identifications are referred to in the order guides to indicate which circuits are made in each toggle position (i.e., 1-2 refers to circuit closure through terminals 1 and 2).

### One Pole

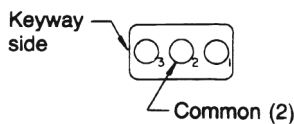

### Two Pole

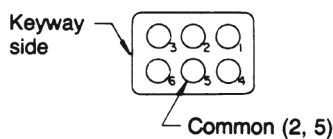

## TERMINALS

In addition to the solder terminal listings in the order guides, IWTS (Integrated Wire Termination System) and quick connection versions are also available.

IWTS provides a reliable, serviceable unit and promotes maintainability since wiring bundles need not be disturbed. Leads are quickly and easily assembled or removed with an insert-extract tool. A unique three-rib (grommet style) elastomer seal protects the lead connections without potting. There are no exposed metal terminals. Versions available that will accept No. 20 wire with MS39029/1-101 contact pins. Connections are resistant to shock, vibration, and high pull-out force.

## SPECIAL CIRCUITRIES

Catalog listings with -10, -50, and -70 suffix numbers, as shown in the order guides, have special “on-on-on” circuits, as illustrated below.

### -10 CIRCUITRY

No of poles	Keyway Side Maint. Position	Center Maint. Position	Opposite Keyway Maint. Position
2			

### -50 CIRCUITRY

No of poles	Keyway Side Maint. Position	Center Maint. Position	Opposite Keyway Maint. Position
2			



### -70 CIRCUITRY

No of poles	Keyway Side Maint. Position	Center Maint. Position	Opposite Keyway Maint. Position
2			

# MICRO SWITCH Miniature Military-Grade Toggle Switch, TW Series

## TW SERIES TWO-POSITION ORDER GUIDE

Table 3. Two-Position TW Series with 15/32 in Bushing

No. of poles	Terminals	Circuits Made with Toggle At:		Sealed Standard Toggle		Pull-to-Unlock Toggle		Colored Paddle Lever***
		Keyway Position	Opposite Keyway	Catalog Listing	Military Number	Add Suffix to Standard Toggle Listing <sup>D</sup>	Military Number**	Add Paddle Color Suffix to _
<b>1</b> 	solder	OFF	2-3 ON	11TW1-2	MS27718-22-1	D, F, G	MS27720-22-1	11TW19-2_
	solder	2-1 ON	2-3 ON	11TW1-3	MS27718-23-1	D, F, G	MS27720-23-1	11TW19-3_
	solder	2-1 ON*	2-3 ON	11TW1-8	MS27718-26-1	F	MS27720-26-1	11TW19-8_
	IWTS	2-1 ON	2-3 ON	111TW1-3	–	D, F, G	–	–
	ITWS	2-1 ON*	2-3 ON	111TW1-8	–	F	–	–
<b>2</b> 	solder	OFF	2-3, 5-6 ON	12TW1-2	MS27719-22-1	D, F, G	MS27721-22-1	12TW19-2_
	solder	2-1, 5-4 ON	2-3, 5-6 ON	12TW1-3	MS27719-23-1	D, F, G	MS27721-23-1	12TW19-3_
	solder	2-1, 5-4 ON*	2-3, 5-6 ON	12TW1-8	MS27719-26-1	F	MS27721-26-1	12TW19-8_
	IWTS	2-1, 5-4 ON	2-3, 5-6 ON	112TW1-3	–	D, F, G	–	–
	IWTS	2-1, 5-4 ON*	2-3, 5-6 ON	112TW1-8	–	F	–	–



\* These positions are momentary. All others are maintained.

\*\* Also add the appropriate suffix to the military number.

\*\*\* See page 8 for paddle lever colors

<sup>A</sup> See page 8 for locking configurations.

Table 4. Two-Position TW Series with 1/4 in Bushing

No. of poles	Terminals	Circuits Made with Toggle At:		Unsealed Standard Toggle		Sealed Standard Toggle
		Keyway Position	Opposite Keyway	Catalog Listing	Military Number	Catalog Listing
<b>1</b> 	solder	OFF	2-3 ON	1TW1-2	MS27716-22-1	1TW101-2
	solder	2-1 ON	2-3 ON	1TW1-3	MS27716-23-1	1TW101-3
	solder	2-1 ON*	2-3 ON	1TW1-8	MS27716-26-1	1TW101-8
<b>2</b> 	solder	OFF	2-3, 5-6 ON	2TW1-2	MS27717-22-1	2TW101-2
	solder	2-1, 5-4 ON	2-3, 5-6 ON	2TW1-3	MS27717-23-1	2TW101-3
	solder	2-1, 5-4 ON*	2-3, 5-6 ON	2TW1-8	MS27717-26-1	2TW101-8

\* These positions are momentary. All others are maintained.

### PULL-TO-UNLOCK OPTION



When ordering pull-to-unlock toggle listings (See page 8 for configurations), add the suffix letter shown in the chart on page 11 to the standard toggle listing or the MS part number. For example, to order a 11TW1-2 pull-to-unlock toggle switch with the lever locked out of the center position,

# MICRO SWITCH Miniature Military-Grade Toggle Switch, TW Series

add the letter **D** (i.e., 11TW1-2D, MS27718-22-1D)

## TW SERIES THREE-POSITION ORDER GUIDE

Table 5. Three-Position TW Series with 15/32 in Bushing

No. of poles	Terminals	Circuits Made with Toggle At:			Sealed Standard Toggle		Pull-to-Unlock Toggle		Colored Paddle Lever***
		Keyway Position	Center Position	Opposite Keyway	Catalog Listing	Military Number	Add Suffix to Standard Toggle Listing <sup>D</sup>	Military Number**	Add Paddle Color Suffix to _
	solder	2-1 ON	OFF	2-3 ON	11TW1-1	MS27718-21-1	ALL	MS27720-21-1	11TW19-1_
	solder	2-1 ON*	OFF	2-3 ON	11TW1-5	MS27718-31-1	E, F, K, L, M, N	MS27720-31-1	11TW19-5_
	solder	2-1 ON*	OFF	2-3 ON*	11TW1-7	MS27718-27-1	E, L, N	MS27720-27-1	11TW19-7_
	IWTS	2-1 ON	OFF	2-3 ON	111TW1-1	-	ALL	-	-
	IWTS	2-1 ON*	OFF	2-3 ON	111TW1-5	-	E, F, K, L, M, N	-	-
	IWTS	2-1 ON*	OFF	2-3 ON*	111TW1-7	-	E, L, N	-	-
	solder	2-1, 5-4 ON	OFF	2-3, 5-6 ON	12TW1-1	MS27719-21-1	ALL	MS27721-21-1	12TW19-1_
	solder	2-1, 5-4 ON*	OFF	2-3, 5-6 ON	12TW1-5	MS27719-31-1	E, F, K, L, M, N	MS27721-31-1	12TW19-5_
	solder	2-1, 5-4 ON*	OFF	2-3, 5-6 ON*	12TW1-7	MS27719-27-1	E, L, N	MS27721-27-1	12TW19-7_
	IWTS	2-1, 5-4 ON	OFF	2-3, 5-6 ON	112TW1-1	-	ALL	-	-
	IWTS	2-1, 5-4 ON*	OFF	2-3, 5-6 ON	112TW1-5	-	E, F, K, L, M, N	-	-
	IWTS	2-1, 5-4 ON*	OFF	2-3, 5-6 ON*	112TW1-7	-	E, L, N	-	-



\* These positions are momentary. All others are maintained.

\*\* Also add the appropriate suffix to the military number.

\*\*\* See page 8 for paddle lever colors

<sup>A</sup> See page 8 for locking configurations.

Table 6. Three-Position TW Series with 1/4 in Bushing

No. of poles	Circuits Made with Toggle At:			Unealed Standard Toggle		Sealed Standard Toggle
	Keyway Position	Center Position	Opposite Keyway	Catalog Listing	Military Number	Catalog Listing
	2-1 ON	OFF	2-3 ON	1TW1-1	MS27716-21-1	1TW101-1
	2-1 ON*	OFF	2-3 ON	1TW1-5	MS27716-31-1	1TW101-5
	2-1 ON*	OFF	2-3 ON*	1TW1-7	MS27716-27-1	1TW101-6
	2-1, 5-4 ON	OFF	2-3, 5-6 ON	2TW1-1	MS27717-21-1	2TW101-2
	2-1, 5-4 ON*	OFF	2-3, 5-6 ON	2TW1-5	MS27717-31-1	2TW101-3
	2-1, 5-4 ON*	OFF	2-3, 5-6 ON*	2TW1-7	MS27717-26-1	2TW101-8

\* These positions are momentary. All others are maintained.

## PULL-TO-UNLOCK OPTION

When ordering pull-to-unlock toggle listings (See page 8 for configurations), add the suffix letter shown in the chart on page 11 to the standard toggle listing or the MS part number. For example, to order a 11TW1-7 pull-to-unlock toggle switch with the lever locked in the center position, add the letter **E** (i.e., 11TW1-7E, MS27720-27-1E)

# MICRO SWITCH Miniature Military-Grade Toggle Switch, TW Series

**Table 7. TW Series Switches with Special Circuitries**

All two-pole, three-position TW switches are available with special “on-on-on” **-10, -50, -70** circuitry options as shown below.

No. of poles	Terminals	Circuits Made with Toggle At:			Sealed Standard Toggle		Unsealed Standard Toggle	Sealed Paddle Lever
		Keyway Position	Center Position	Opposite Keyway	15/32 Bushing Catalog Listing	1/4 Bushing Catalog Listing	1/4 Bushing Catalog Listing	15/32 Bushing Catalog Listing***
2 	solder	2-1, 5-4 ON	2-1, 5-6 ON	2-3, 5-6 ON	12TW1- <b>10</b>	2TW101- <b>10</b>	2TW1- <b>10</b>	12TW19- <b>10</b> _
	solder	2-1, 5-4 ON*	2-1, 5-6 ON	2-3, 5-6 ON	12TW1- <b>50</b>	2TW101- <b>50</b>	2TW1- <b>50</b>	12TW19- <b>50</b> _
	solder	2-1, 5-4 ON*	2-1, 5-6 ON	2-3, 5-6 ON*	12TW1- <b>70</b>	2TW101- <b>70</b>	2TW1- <b>70</b>	12TW19- <b>70</b> _

\* These positions are momentary. All others are maintained.

\*\*\* Add color suffix from Table 8 on page 11.

# MICRO SWITCH Miniature Military-Grade Toggle Switch, TW Series

## MICRO SWITCH TW SERIES 1-POLE STANDARD ACTUATOR OPTIONS, TERMINALS, & DIMENSIONS

Note: Three-position switches shown

111TW1: Single pole, standard lever, 15/32 bushing, solder terminals	111TW1: Single pole, standard lever, 15/32 bushing, IWTS	1TW1: Single pole, standard lever, 1/4 bushing, solder terminals
<p>Technical drawing of the 111TW1 switch. Front view shows a width of 14.6 [0.575] max. and a height of 13.6 [0.535] max. The actuator has a diameter of 6.1 [0.24]. Side view shows a 28° ±4° total travel. Key dimensions include a 1.83 x 0.76 [0.072 x 0.03] deep keyway, 15/32-32 UNS thread to within 1.58 [0.062] of shoulder, 12.95 [0.51] dia. shoulder on bushing, and a 12.95 [0.51] dia. shoulder on the main body. Terminal dimensions include 1.78 [0.07] and 1.02 [0.04] diameters, and 2.54 [0.10] and 2.03 [0.08] spacings. The terminal block is labeled MICRO USA.</p>	<p>Technical drawing of the 111TW1 switch with IWTS. Side view shows a 28° ±4° total travel. Key dimensions include a 1.83 x 0.76 [0.072 x 0.03] deep keyway, 15/32-32 UNS thread to within 1.58 [0.062] of shoulder, 12.95 [0.51] dia. shoulder on bushing, and a 12.95 [0.51] dia. shoulder on the main body. An environmental seal is present at the base. Front view shows a 4.57 [0.175] width, 6.6 [0.26] height, and 14.6 [0.575] max. width. It features 3X termination and a 13.6 [0.535] max. diameter.</p>	<p>Technical drawing of the 1TW1 switch. Front view shows a width of 14.6 [0.575] max. and a height of 8.76 [0.345] max. The actuator has a diameter of 2.79 [0.11]. Side view shows a 35° ±5° total travel and a 17° angle. Key dimensions include a 0.055 wide x 0.03 deep keyway, 1/4-40 UNS thread to within 1.27 [0.05] of shoulder, and a 7.87 [0.31] diameter shoulder on the bushing. Terminal dimensions include 1.78 [0.07] and 1.02 [0.04] diameters, and 2.54 [0.10] and 2.03 [0.08] spacings. The terminal block is labeled MICRO USA.</p>

### Locking lever dimensions for single pole TW toggles

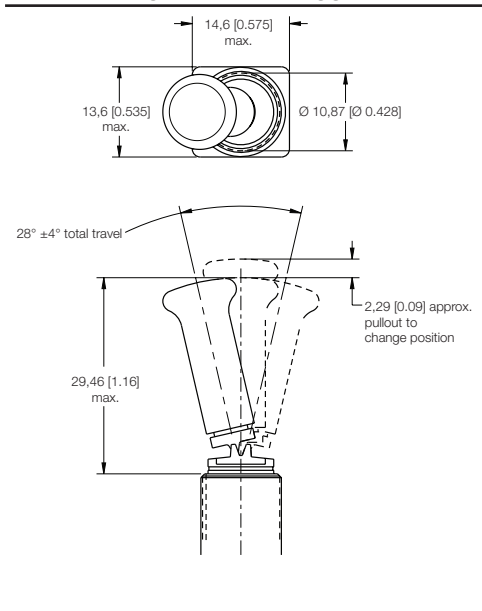

### Colored paddle dimensions for single pole TW toggles

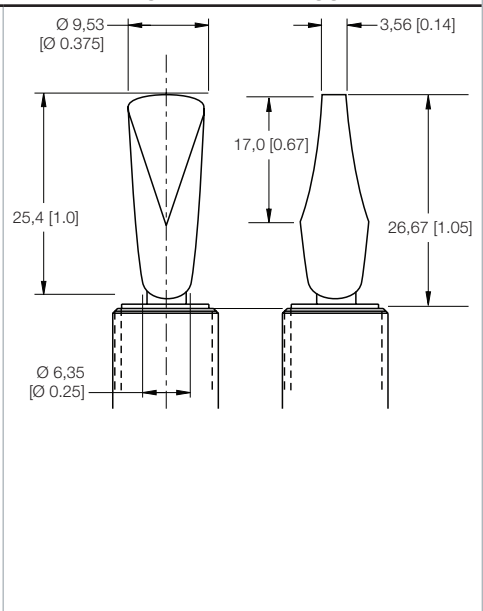

# MICRO SWITCH Miniature Military-Grade Toggle Switch, TW Series

## MICRO SWITCH™ TW SERIES 2-POLE STANDARD ACTUATOR OPTIONS, TERMINALS, & DIMENSIONS

**Note: Three-position switches shown**

12TW1: Single pole, standard lever, 15/32 bushing, solder terminals	112TW1: Single pole, standard lever, 15/32 bushing, IWTS	2TW1: Single pole, standard lever, 1/4 bushing, solder terminals
<p>1,83 x 0,76 [0,072 x 0,03] deep keyway            14,6 [0,575] max.            Ø 6,1 [Ø 0,24]            13,6 [0,535] max.            28° ±4° total travel            17,27 [0,68]            Sealed to prevent entrance of liquid or dust            15/32-32 UNS thread to within 1,58 [0,062] of shoulder            11,94 [0,47]            12,95 [0,51] dia. shoulder on bushing            18,8 [0,74] max.            0,51 [0,02]            2,03 [0,08]            Ø 1,78 [Ø 0,07]            Ø 1,02 [Ø 0,04]            4,57 [0,175]            2,54 [0,10]            4,57 [0,175]            3,05 [0,12]            6,9 [0,27]            MICRO USA</p>	<p>28° ±4° total travel            Ø 6,1 [Ø 0,24]            17,27 [0,68]            1,83 x 0,76 [0,072 x 0,03] deep keyway            11,94 [0,47]            15/32-32 UNS thread to within 1,58 [0,062] of shoulder            12,95 [0,51] dia. shoulder on bushing            32,5 [1,28] max.            Environmental seal            4,57 [0,175]            4,57 [0,175]            3,05 [0,12]            6,9 [0,27]            13,6 [0,535] max.            14,99 [0,590] max.</p>	<p>14,6 [0,575] max.            Ø 2,79 [Ø 0,11]            13,6 [0,535] max.            35° ±5° total travel            17°            10,67 [0,42]            0,055 wide x 0,03 deep keyway            1/4-40 UNS thread to within 1,27 [0,05] of shoulder            Ø 7,87 [Ø 0,31] shoulder on bushing            6,35 [0,25]            16,26 [0,64] max.            0,51 [0,02]            2,54 [0,10]            Ø 1,78 [Ø 0,07]            Ø 1,02 [Ø 0,04]            4,57 [0,175]            2,54 [0,10]            4,57 [0,175]            3,05 [0,12]            6,9 [0,27]            MICRO USA</p>

### Locking lever dimensions for double pole TW toggles

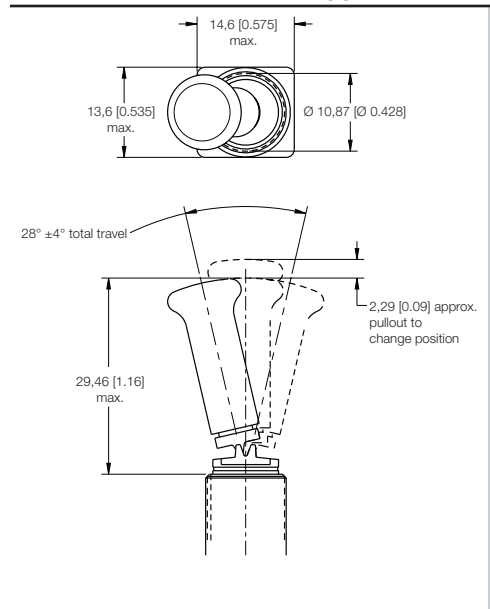



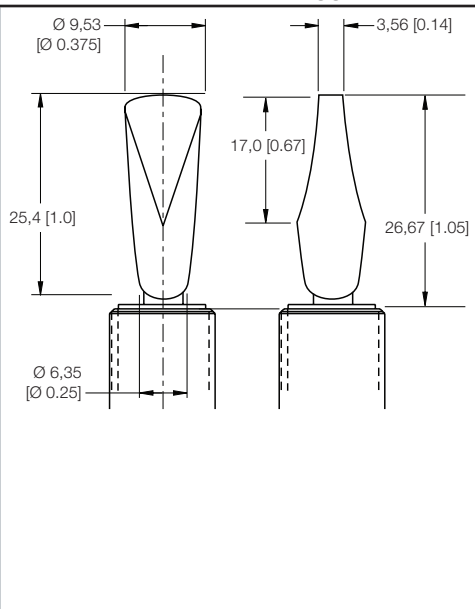









### Colored paddle dimensions for double pole TW toggles



# MICRO SWITCH Miniature Military-Grade Toggle Switch, TW Series

## MICRO SWITCH TW SERIES LOCKING CONFIGURATIONS

<b>A</b>  Locked In Three Positions	<b>B</b>  Locked In Center and Extreme Position (Keyway Side)	<b>D</b>  Locked Out Of Center Position	<b>E</b>  Locked In Center Position	<b>F</b>  Locked In Extreme Position (Opposite Keyway)	<b>G</b>  Locked In Extreme Position (Keyway Side)	<b>H</b>  Locked Out Of Center And Extreme Position (Keyway Side)
<b>J</b>  Locked Out Of Center And Extreme Position (Opposite Keyway)	<b>K</b>  Locked In Center And Extreme Position (Opposite Keyway)	<b>L</b>  Locked Out Of Extreme Position (Keyway Side)	<b>M</b>  Locked Out Of And Into Extreme Position (Opposite Keyway)	<b>N</b>  Locked Out Of Extreme Position (Opposite Keyway)	<b>P</b>  Locked Out Of And Into Extreme Position (Keyway Side)	

**Table 8. Paddle Lever Colors**

Color Suffix	Paddle Lever Color
A001	White
A002	Black
A003	Blue
A004	Red
A005	Green
A006	Orange
A007	Light Grey



## ADDITIONAL MATERIALS

The following associated literature is available on the Honeywell web site at [sensing.honeywell.com](http://sensing.honeywell.com):

- Product installation instructions
- Product range guide
- Product application-specific information
  - Flight deck toggle switches
  - Sensors and switches in front loaders
  - Sensors and switches in mobile cranes
  - Sensors and switches in oil rig applications

### For more information

Honeywell Sensing and Internet of Things services its customers through a worldwide network of sales offices and distributors. For application assistance, current specifications, pricing or the nearest Authorized Distributor, visit [sensing.honeywell.com](http://sensing.honeywell.com) or call:

Asia Pacific	+65 6355-2828
Europe	+44 (0) 1698 481481
USA/Canada	+1-800-537-6945

### Honeywell Sensing and Internet of Things

9680 Old Bailes Road  
Fort Mill, SC 29707  
[www.honeywell.com](http://www.honeywell.com)

## **WARNING** **PERSONAL INJURY**

DO NOT USE these products as safety or emergency stop devices or in any other application where failure of the product could result in personal injury.

**Failure to comply with these instructions could result in death or serious injury.**

## **WARNING** **MISUSE OF DOCUMENTATION**

- The information presented in this product sheet is for reference only. Do not use this document as a product installation guide.
- Complete installation, operation, and maintenance information is provided in the instructions supplied with each product.

**Failure to comply with these instructions could result in death or serious injury.**

### Warranty/Remedy

Honeywell warrants goods of its manufacture as being free of defective materials and faulty workmanship during the applicable warranty period. Honeywell's standard product warranty applies unless agreed to otherwise by Honeywell in writing; please refer to your order acknowledgment or consult your local sales office for specific warranty details. If warranted goods are returned to Honeywell during the period of coverage, Honeywell will repair or replace, at its option, without charge those items that Honeywell, in its sole discretion, finds defective. **The foregoing is buyer's sole remedy and is in lieu of all other warranties, expressed or implied, including those of merchantability and fitness for a particular purpose. In no event shall Honeywell be liable for consequential, special, or indirect damages.**

While Honeywell may provide application assistance personally, through our literature and the Honeywell web site, it is buyer's sole responsibility to determine the suitability of the product in the application.

Specifications may change without notice. The information we supply is believed to be accurate and reliable as of this writing. However, Honeywell assumes no responsibility for its use.