

## Features

- Epitaxial Planar Die Construction
- Ideally Suited for Automated Assembly Processes
- Ideal for Medium Power Switching or Amplification Applications
- Complementary NPN Type Available (2DC4672)
- **Lead Free By Design/RoHS Compliant (Note 1)**
- **"Green" Device (Note 2)**

## Mechanical Data

- Case: SOT89-3L
- Case Material: Molded Plastic, "Green" Molding Compound. UL Flammability Classification Rating 94V-0
- Moisture Sensitivity: Level 1 per J-STD-020D
- Terminals: Finish — Matte Tin annealed over Copper leadframe (Lead Free Plating). Solderable per MIL-STD-202, Method 208
- Marking Information: See Page 4
- Ordering Information: See Page 4
- Weight: 0.072 grams (approximate)



Top View

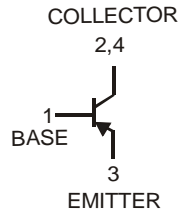

Device Schematic

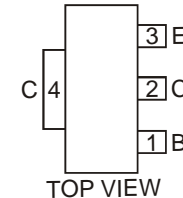

Pin Out Configuration

## Maximum Ratings @ $T_A = 25^\circ\text{C}$ unless otherwise specified

Characteristic	Symbol	Value	Unit
Collector-Base Voltage	$V_{CBO}$	-50	V
Collector-Emitter Voltage	$V_{CEO}$	-50	V
Emitter-Base Voltage	$V_{EBO}$	-6	V
Peak Pulse Current	$I_{CM}$	-6	A
Continuous Collector Current	$I_C$	-3	A

## Thermal Characteristics

Characteristic	Symbol	Value	Unit
Power Dissipation (Note 3) @ $T_A = 25^\circ\text{C}$	$P_D$	0.9	W
Thermal Resistance, Junction to Ambient Air (Note 3) @ $T_A = 25^\circ\text{C}$	$R_{\theta JA}$	139	$^\circ\text{C/W}$
Power Dissipation (Note 4) @ $T_A = 25^\circ\text{C}$	$P_D$	2	W
Thermal Resistance, Junction to Ambient Air (Note 4) @ $T_A = 25^\circ\text{C}$	$R_{\theta JA}$	62.5	$^\circ\text{C/W}$
Operating and Storage Temperature Range	$T_J, T_{STG}$	-55 to +150	$^\circ\text{C}$

## Electrical Characteristics @ $T_A = 25^\circ\text{C}$ unless otherwise specified

Characteristic	Symbol	Min	Typ	Max	Unit	Conditions
<b>OFF CHARACTERISTICS</b>						
Collector-Base Breakdown Voltage	$V_{(BR)CBO}$	-50	—	—	V	$I_C = -50\mu\text{A}, I_E = 0$
Collector-Emitter Breakdown Voltage (Note 5)	$V_{(BR)CEO}$	-50	—	—	V	$I_C = -1\text{mA}, I_B = 0$
Emitter-Base Breakdown Voltage	$V_{(BR)EBO}$	-6	—	—	V	$I_E = -50\mu\text{A}, I_C = 0$
Collector Cut-Off Current	$I_{CBO}$	—	—	-0.1	$\mu\text{A}$	$V_{CB} = -50\text{V}, I_E = 0$
Emitter Cut-Off Current	$I_{EBO}$	—	—	-0.1	$\mu\text{A}$	$V_{EB} = -5\text{V}, I_C = 0$
<b>ON CHARACTERISTICS (Note 5)</b>						
Collector-Emitter Saturation Voltage	$V_{CE(SAT)}$	—	-100	-350	mV	$I_C = -1\text{A}, I_B = -50\text{mA}$
DC Current Gain	$h_{FE}$	82	—	270	—	$V_{CE} = -2\text{V}, I_C = -500\text{mA}$
<b>SMALL SIGNAL CHARACTERISTICS</b>						
Output Capacitance	$C_{obo}$	—	27	—	pF	$V_{CB} = -10\text{V}, I_E = 0, f = 1\text{MHz}$
Current Gain-Bandwidth Product	$f_T$	—	160	—	MHz	$V_{CE} = -2\text{V}, I_C = -100\text{mA}, f = 100\text{MHz}$

- Notes:
1. No purposefully added lead.
  2. Diodes Inc.'s "Green" policy can be found on our website at [http://www.diodes.com/products/lead\\_free/index.php](http://www.diodes.com/products/lead_free/index.php).
  3. Device mounted on FR-4 PCB with minimum recommended pad layout.
  4. Device mounted on FR-4 PCB with 1 inch<sup>2</sup> copper pad layout.
  5. Measured under pulsed conditions. Pulse width = 300 $\mu\text{s}$ . Duty cycle  $\leq 2\%$ .

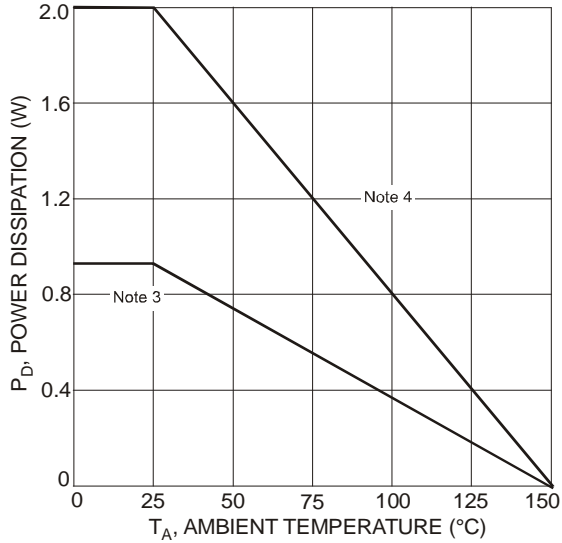

Fig. 1 Power Dissipation vs. Ambient Temperature

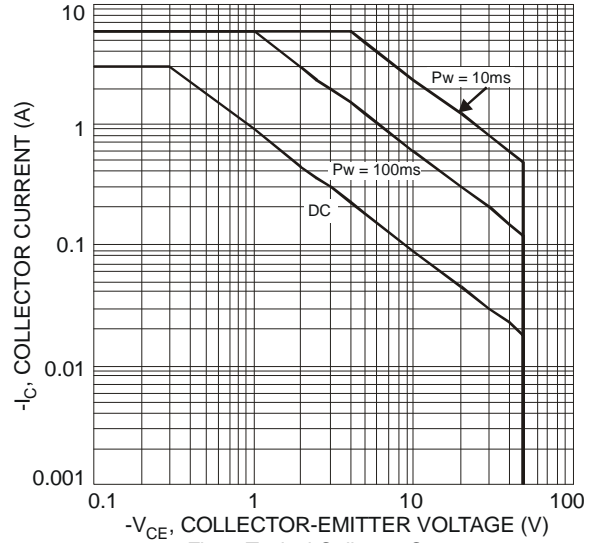

Fig. 2 Typical Collector Current vs. Collector-Emitter Voltage (Note 3)

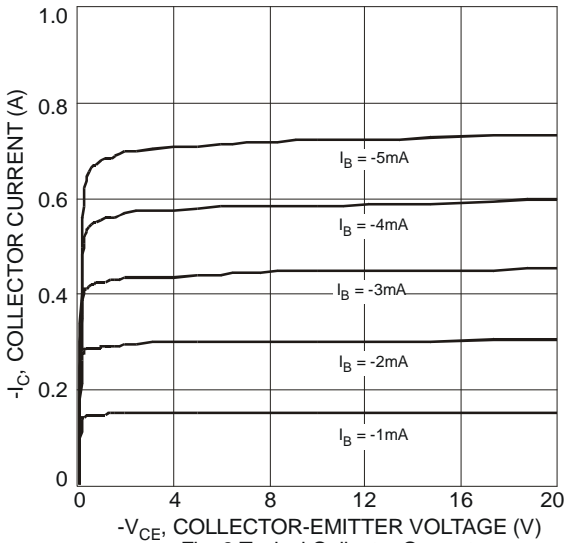

Fig. 3 Typical Collector Current vs. Collector-Emitter Voltage

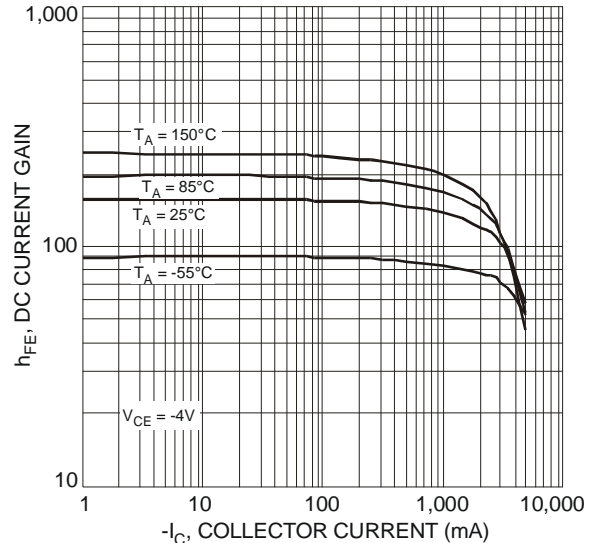

Fig. 4 Typical DC Current Gain vs. Collector Current

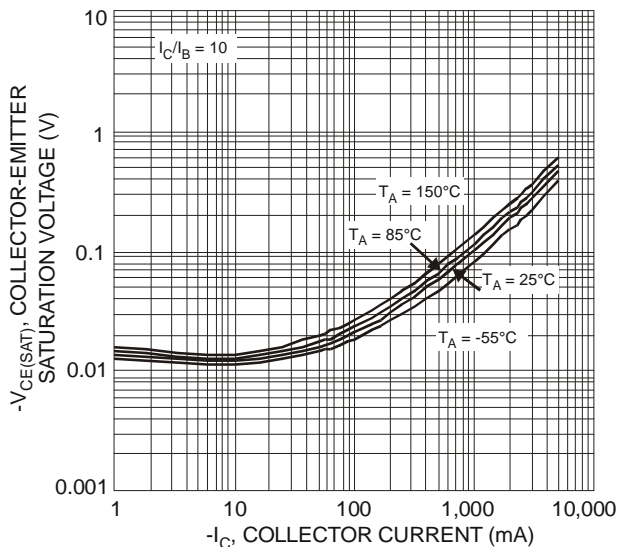

Fig. 5 Typical Collector-Emitter Saturation Voltage vs. Collector Current

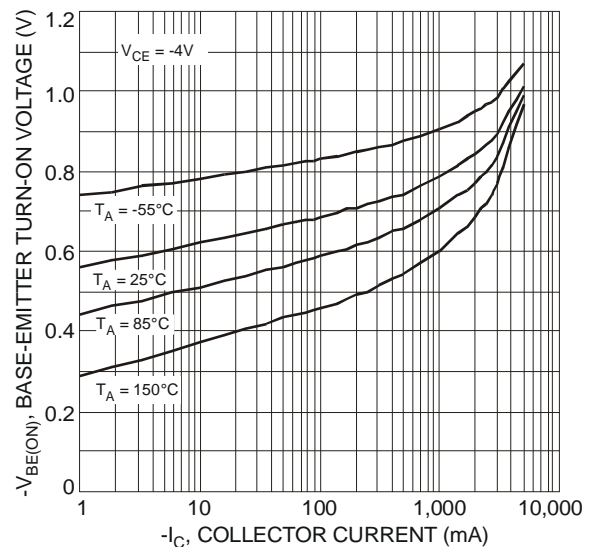

Fig. 6 Typical Base-Emitter Turn-On Voltage vs. Collector Current

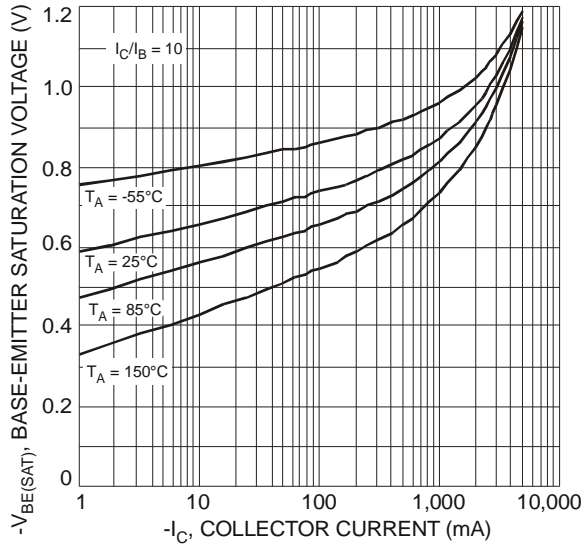

Fig. 7 Typical Base-Emitter Saturation Voltage vs. Collector Current

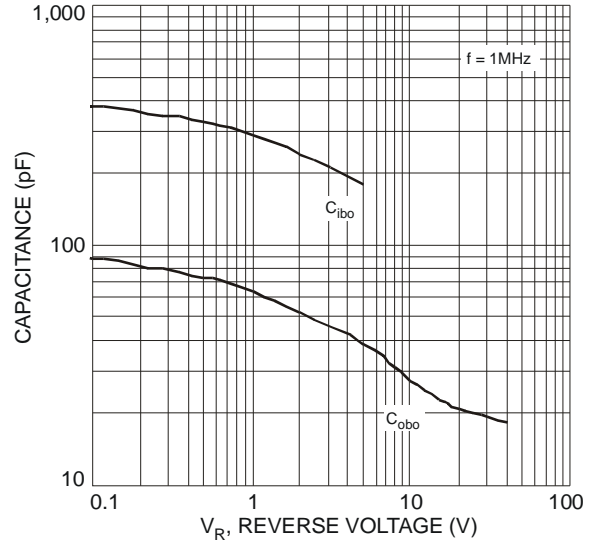

Fig. 8 Typical Capacitance Characteristics

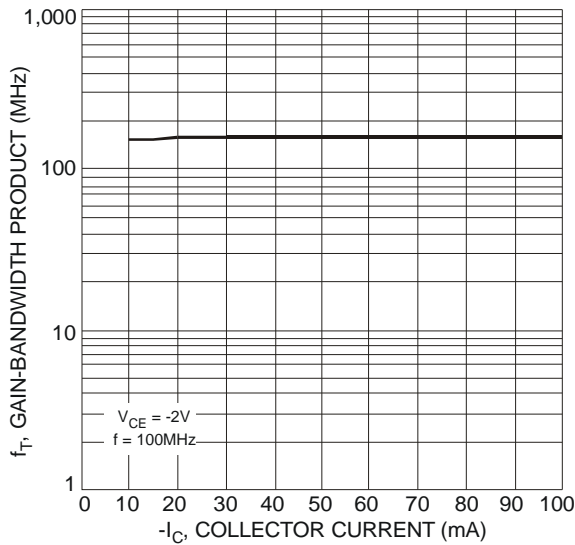

Fig. 9 Typical Gain-Bandwidth Product vs. Collector Current

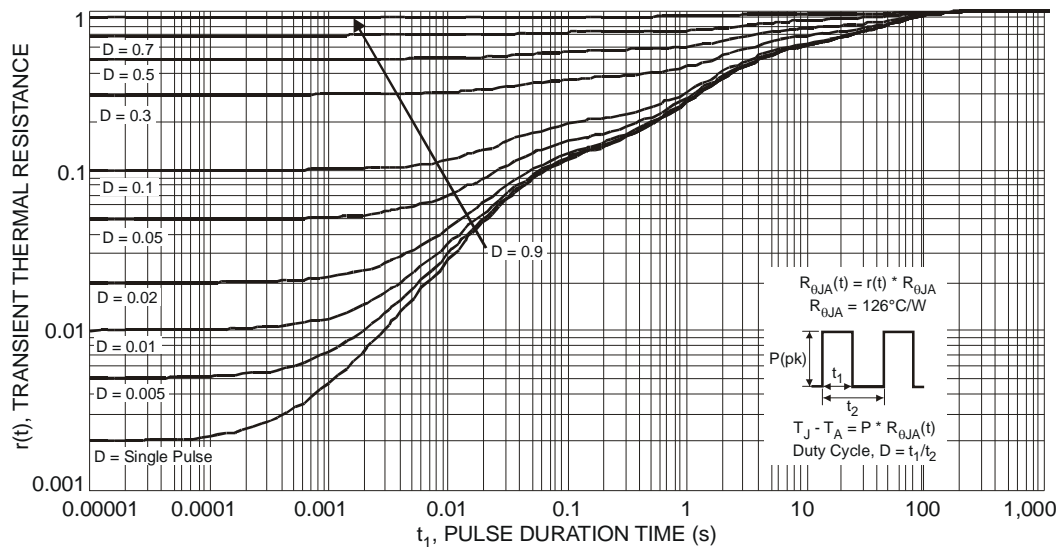
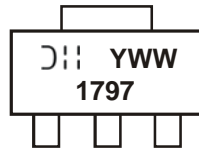

Fig. 10 Transient Thermal Response

**Ordering Information** (Note 6)

Part Number	Case	Packaging
2DA1797-13	SOT89-3L	2500/Tape & Reel

Notes: 6. For packaging details, go to our website at <http://www.diodes.com/datasheets/ap02007.pdf>.

**Marking Information**

1797 = Product Type Marking Code  
 YWW = Date Code Marking  
 Y = Last digit of year (ex: 8 = 2008)  
 WW = Week code 01 - 52

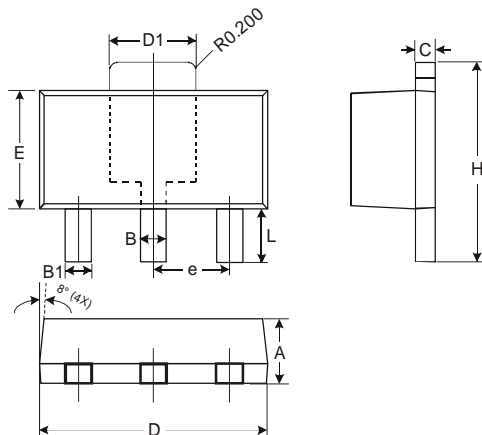
**Package Outline Dimensions**

SOT89-3L			
Dim	Min	Max	Typ
A	1.40	1.60	1.50
B	0.45	0.55	0.50
B1	0.37	0.47	0.42
C	0.35	0.43	0.38
D	4.40	4.60	4.50
D1	1.50	1.70	1.60
E	2.40	2.60	2.50
e	—	—	1.50
H	3.95	4.25	4.10
L	0.90	1.20	1.05
All Dimensions in mm			

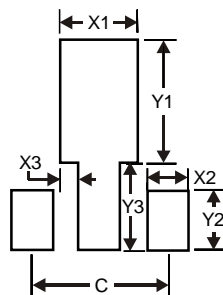
**Suggested Pad Layout**

Dimensions	Value (in mm)
X1	1.7
X2	0.9
X3	0.4
Y1	2.7
Y2	1.3
Y3	1.9
C	3.0

**IMPORTANT NOTICE**

Diodes Incorporated and its subsidiaries reserve the right to make modifications, enhancements, improvements, corrections or other changes without further notice to any product herein. Diodes Incorporated does not assume any liability arising out of the application or use of any product described herein; neither does it convey any license under its patent rights, nor the rights of others. The user of products in such applications shall assume all risks of such use and will agree to hold Diodes Incorporated and all the companies whose products are represented on our website, harmless against all damages.

**LIFE SUPPORT**

Diodes Incorporated products are not authorized for use as critical components in life support devices or systems without the expressed written approval of the President of Diodes Incorporated.