

Spezifikation für Freigabe / specification for release

Kunde / customer :

Artikelnummer / part number : **744242510**

LF



Bezeichnung : **STROMKOMP. SMD LINE FILTER WE-SLM**
 description : **COMMON MODE SMD LINE FILTER WE-SLM**

DATUM / DATE : 2005-07-28

A Mechanische Abmessungen / dimensions:

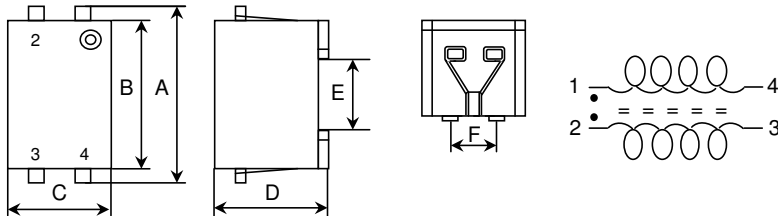

A	6,00 ± 0,3	mm
B	5,00 ± 0,3	mm
C	3,30 ± 0,3	mm
D	3,30 ± 0,2	mm
E	3,10 typ.	mm
F	1,27 typ.	mm
G		mm
H		mm

B Elektrische Eigenschaften / electrical properties:

Eigenschaften / properties	Testbedingungen / test conditions		Wert / value	Einheit / unit	tol.
Induktivität / inductance	0,1V / 100KHz	$L_{1-2;3-4}$	51	μH	+50/-30%
DC-Widerstand / DC-resistance		R_{DC}	0,32	Ω	max.
Nennstrom / rated current	$\Delta T = 40\text{K}$	I_{DC}	300	mA	max.
Impedanz / impedance		Z_{max}	2500	Ω	typ.
Nennspannung / rated voltage		U_{DC}	80	V_{DC}	max.

C Lötpad / soldering spec.:

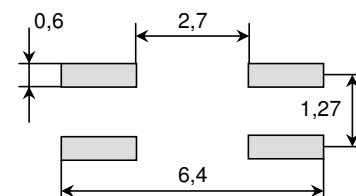

D Prüfgeräte / test equipment:

HP 4191 B für/for Z und/and material

HP 34401 A für/for R_{DC} und/and IDC

E Testbedingungen / test conditions:

Luftfeuchtigkeit / humidity: 33%
 Umgebungstemperatur / temperature: +20°C
 High-Pot Test (60Hz;3mA;1min.) 250VAC

F Werkstoffe & Zulassungen / material & approvals:

Basismaterial / base material: Ferrit / ferrite
 Draht / wire: Class F
 Gehäuse / Housing: UL94-V0

G Eigenschaften / general specifications:

Betriebstemp. / operating temperature: -40°C - +125°C
 Umgebungstemp. / ambient temperature: -40°C - +85°C
 It is recommended that the temperature of the part does not exceed 125°C under worst case operating conditions.

Freigabe erteilt / general release:	Kunde / customer		
Datum / date	Unterschrift / signature		
	Würth Elektronik		
Geprüft / checked	Kontrolliert / approved		
	MST	Version 1	05-07-28
	Name	Änderung / modification	Datum / date

Würth Elektronik eiSos GmbH & Co. KG

D-74638 Waldenburg · Max-Eyth-Strasse 1 - 3 · Germany · Telefon (+49) (0) 7942 - 945 - 0 · Telefax (+49) (0) 7942 - 945 - 400

Spezifikation für Freigabe / specification for release

Kunde / customer : _____
 Artikelnummer / part number : **744242510**
 Bezeichnung : **STROMKOMP. SMD LINE FILTER WE-SLM**
 description : **COMMON MODE SMD LINE FILTER WE-SLM**

LF



DATUM / DATE : 2005-07-28

H Impedanzverlauf / impedance curve:

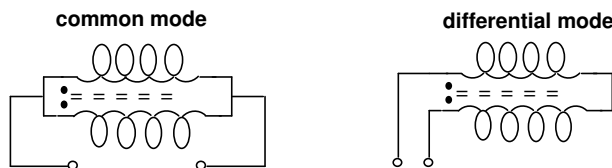
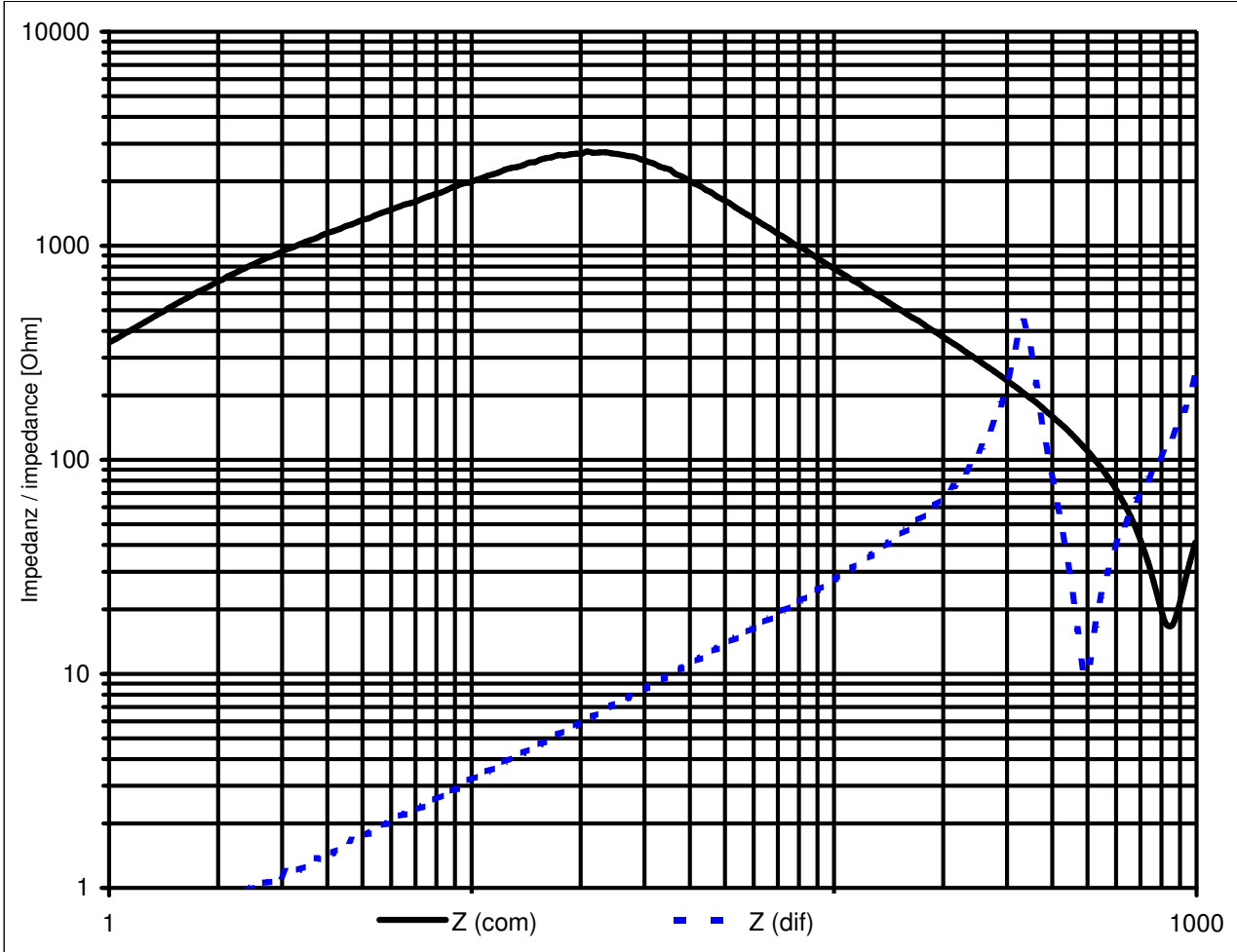

Freigabe erteilt / general release:	Kunde / customer			
Datum / date	Unterschrift / signature			
	Würth Elektronik			
Geprüft / checked	Kontrolliert / approved	MST	Version 1	05-07-28
		Name	Änderung / modification	Datum / date

Würth Elektronik eiSos GmbH & Co. KG

D-74638 Waldenburg · Max-Eyth-Strasse 1 - 3 · Germany · Telefon (+49) (0) 7942 - 945 - 0 · Telefax (+49) (0) 7942 - 945 - 400

Spezifikation für Freigabe / specification for release

Kunde / customer : _____
 Artikelnummer / part number : **744242510**
 Bezeichnung : **STROMKOMP. SMD LINE FILTER WE-SLM**
 description : **COMMON MODE SMD LINE FILTER WE-SLM**

LF



DATUM / DATE : 2005-07-28

I Rollenspezifikation / tape and reel specification:

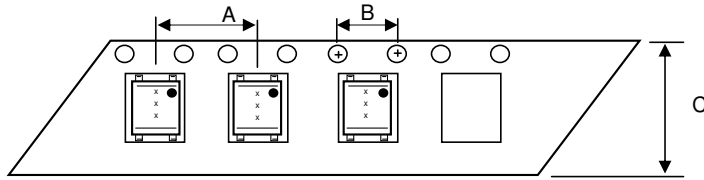

Gurtspezifikation / Tape specification:		
A	8 ± 1,0	mm
B	4 ± 1,0	mm
C	16 ± 1,0	mm
D		mm
E		mm
F		mm
G		mm
H		mm
I		mm
J		mm
T		mm

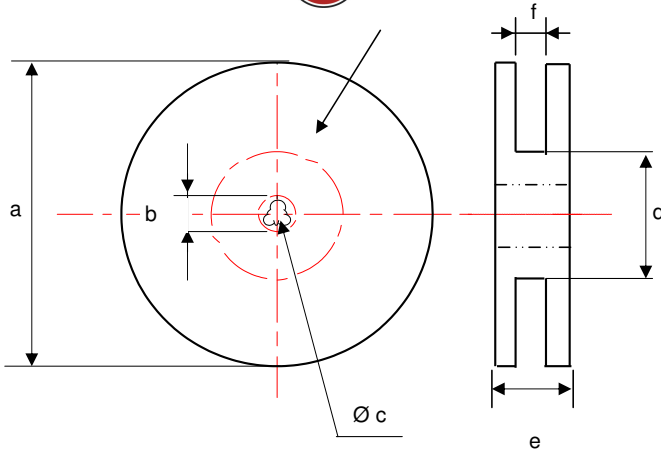

Rollenspezifikation / Reel specification:		
a	178 ± 2,0	mm
b	21 ± 0,8	mm
c	13 ± 0,5	mm
d	50 ± 1,0	mm
e	20,5	mm
f	18	mm

quantity: 500 pieces

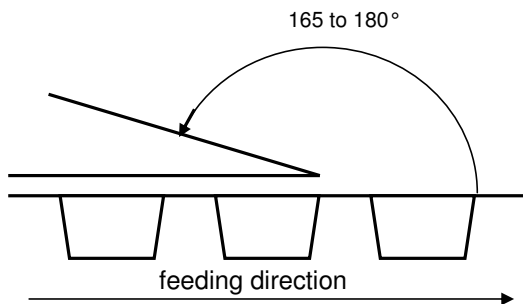

The force for tearing off cover tape is 10 to 130 grams in arrow direction

Freigabe erteilt / general release:	Kunde / customer		
	Unterschrift / signature		
	Würth Elektronik		
	MST	Version 1	05-07-28
	Name	Änderung / modification	Datum / date

This electronic component is designed and developed with the intention for use in general electronics equipments. Before incorporating the components into any equipments in the field such as aerospace, aviation, nuclear control, submarine, transportation, (automotive control, train control, ship control), transportation signal, disaster prevention, medical, public information network etc. where higher safety and reliability are especially required or if there is possibility of direct damage or injury to human body. In addition, even electronic component in general electronic equipments, when used in electrical circuits that require high safety, reliability functions or performance, the sufficient reliability evaluation-check for the safety must be performed before use. It is essential to give consideration when to install a protective circuit at the design stage.

Würth Elektronik eiSos GmbH & Co. KG

D-74638 Waldenburg · Max-Eyth-Strasse 1 - 3 · Germany · Telefon (+49) (0) 7942 - 945 - 0 · Telefax (+49) (0) 7942 - 945 - 400
<http://www.we-online.com>