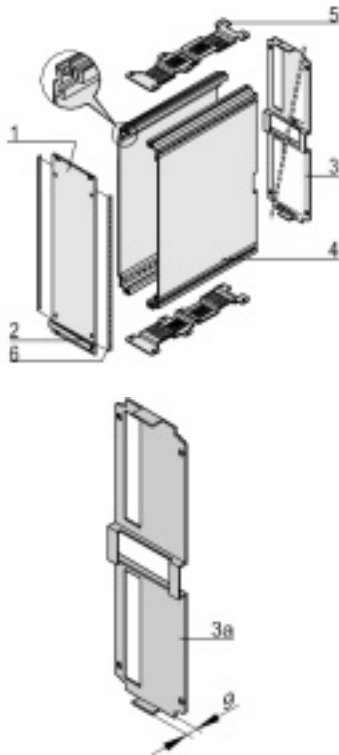

**Frame-type 5 plug-in units 3/6 U kits**
[Print page](#)

**Article number: 20846-649**

- Right and left extruded side panels with grooves for sliding in printed board (standard card position only on the left)
- Assembly of further printed boards via assembly of guide rails in the perforated covers
- Front panel EMC shielded, covers with perforation

**Delivery comprises: kit**

Item	Qty	Description
1	1	Front panel, Al, 2.5 mm, front anodised, rear colourless chromated
2	1	Handle, grey, PPE, UL 04 V-1
3a	1	Rear panel, Al, 1.5 mm, with cut-out for one connector
4	2	Side panel, Al extrusion, with groove for one printed board
5	2	Cover, perforated, Al, 1 mm
6	2	EMC contact strips, stainless steel
7	1	Assembly kit

**Technical data:**

Height	Width	Description	Description
6 U	12 HP	T = 167 mm front panel, shielded	Rear panel with cut-out for 1 connector

**Technical data:**

T = plug-in unit side panel depth

**Further Information:**



User Manual  
User Manual  
User Manual  
User Manual