

**Laird**  
TECHNOLOGIES®

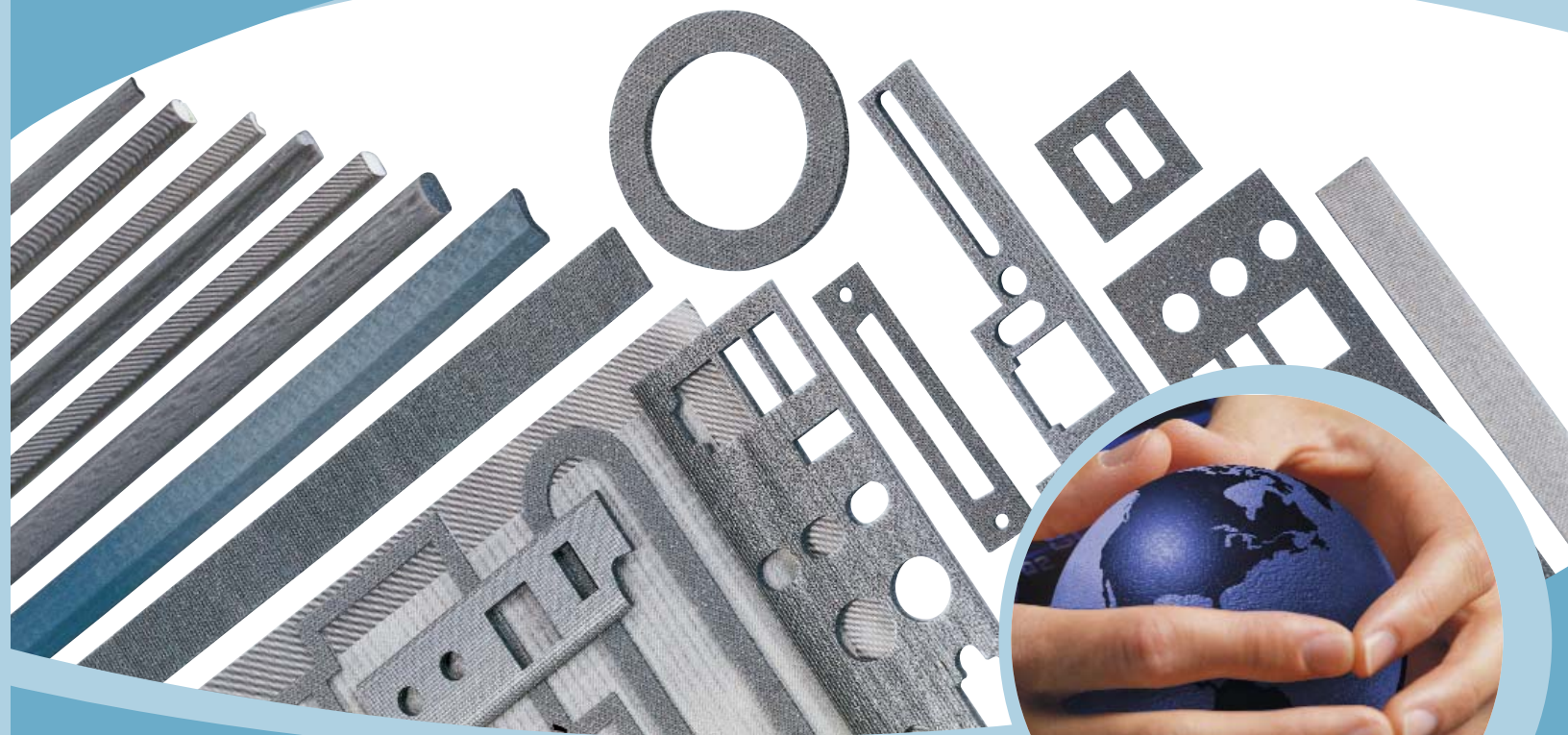

global solutions :  
local support™

| Metallized Conductive Products

engineered emi, antenna and thermal applications

Laird Technologies is the world's leading designer and manufacturer of electromagnetic interference [EMI] shielding materials, thermal interface products, and wireless antenna solutions for the telecommunications, data communications, computer, general electronics, network equipment, aerospace, defense, automotive and medical equipment industries. Laird Technologies has unrivaled product lines, dedication to R & D, and a seamless network of manufacturing and customer support facilities in the Americas, Europe, and Asia.

Laird Technologies' EMI product line includes beryllium copper fingerstock, knitted wire mesh, conductive elastomers in extruded profiles, molded shapes and form-in-place gaskets, fabric-over-foam and a full range PC board shields, shielded windows, custom metal stampings and ventilation panels. Also offered are microwave and EMI microwave absorber products. In addition, the company provides EMC product engineering services.

Laird Technologies offers –

- All products are manufactured under ISO 9001 and ISO 14001 standards
- Engineering and design assistance
- Product samples and/or sample kits
- RoHS compliant products

This catalog is designed to provide technical specifications and material characteristics for all categories of metallized fabric and foam products.

These products include:

## Fabric-Over-Foam

Profile and Input/Output (I/O) EMI shielding gaskets available in UL94 V0 and HB flame retardant material — ideal for applications requiring low compression force.

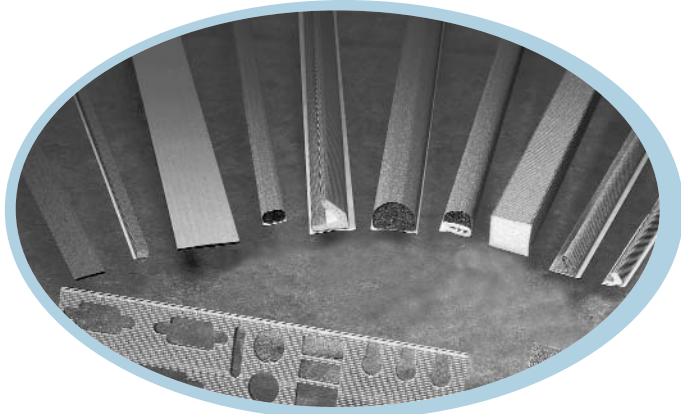

## Conductive Foam

Conductive foam gaskets provide the enhanced EMI shielding effectiveness required by the microprocessor speeds of today's computer and telecommunications equipment. Conductive foam gaskets are available in UL94 V0 or HB.



## Conductive Fabric

Metallized fabric combines highly conductive metals with lightweight fabric to meet a diverse range of EMI/RFI shielding requirements.

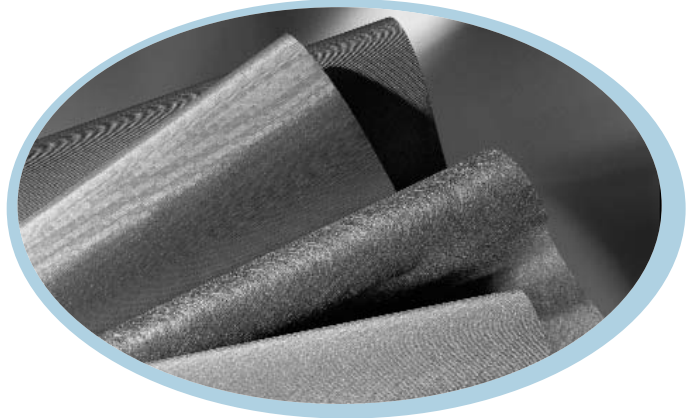

## Conductive Tape

Conductive shielding tape offers excellent conductivity, conformability and durability in a thin, lightweight and flexible shielding design.

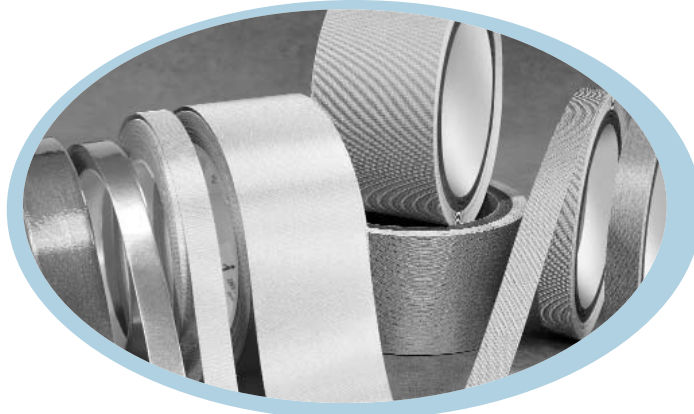



**Part Number Cross Reference** ..... 3-6



**Fabric-Over-Foam Shielding Gaskets**

Introduction ..... 7  
 Profile and I/O Construction Options ..... 8  
 Profile Selection Guide  
     D-Shaped ..... 9  
     Rectangle Shaped ..... 9-10  
     D-Shaped Clip ..... 11  
     Rectangle Shaped Clip ..... 11  
     C-Fold Shaped ..... 11  
     Square Shaped ..... 11  
     P-Shaped ..... 11  
     Knife Shaped ..... 12  
     J-Shaped ..... 12  
     Bell Shaped ..... 12  
     C-Fold With Clip ..... 12  
     Double D-Shaped ..... 13  
     Double Rectangle Shaped ..... 13  
     L-Shaped ..... 13  
     Oval Shaped ..... 13  
     Round Shaped ..... 13  
     T-Shaped ..... 13  
 How To Order ..... 18  
 Sculpted Foam ..... 19-20



**Fabric-Over-Foam I/O Gaskets**

Introduction ..... 14  
 I/O Gaskets Selection Guide  
     D-Sub Connector Series ..... 15  
     USB Port 4 Pin Connector ..... 15  
     I/O Connector ..... 15  
     IEEE 1394 I/O 4 Pin Connector ..... 16  
     SCSI + 50 Pin Connector ..... 16  
     RJ 11 Connector ..... 16  
     SCSI + 68 Pin Connector ..... 17  
     USB Port Connector ..... 17  
 How To Order ..... 18



**Conductive Foam**

Introduction ..... 21  
 Profile Selection Guide  
     Rectangle Shaped ..... 22  
 I/O Gaskets Selection Guide  
     D-Sub Connector Series ..... 23  
     USB Port 4 Pin Connector ..... 23  
     USB Port Connector ..... 24  
     I/O Connector ..... 24  
 Backplanes – Large Conductive Foam Gaskets Selection Guide ..... 25  
 How To Order ..... 26



**Conductive Fabric** ..... 27-28



**Conductive Tape**

MRI "A" Fabric ..... 29  
 Conductive ElectroMask Tape ..... 30  
 High-Flex® Conductive Fabric Shielding Tapes ..... 31  
 How To Order (High-Flex Tapes) ..... 31



Part #	Product	Page
<b>Conductive Fabric</b>		
3027-106	Cu Polyester Nonwoven	27
3027-217	Ni/Cu Polyester Nonwoven	27
3027-235	Ni/Cu Polyester Nonwoven UL94 VTM-0	27
3035-213	Ni/Cu Polyester Taffeta	27
3035-216	Ni/Cu Polyester Taffeta UL94 V0	27
3050-113	Cu Nylon Ripstop	27
3050-226	Ni/Cu Nylon Ripstop	27
3050-517	Ni/Cu Nylon Ripstop UL94 V0	27
3055-121	Cu Polyester Ripstop	27
3055-233	Ni/Cu Polyester Ripstop	27
3070-500	Ni/Cu Polyester Mesh	27

### Fabric-Over-Foam

4032	C-Fold with Clip	12
4033	D-Shaped Clip	11
4038	D-Shaped Clip	11
4039	D-Shaped Clip	11
4040	D-Shaped Clip	11
4041	D-Shaped Clip	11
4042	Rectangle Shaped	10
4043	D-Shaped Clip	11
4046	Square Shaped	11
4047	Rectangle Shaped	10
4048	Square Shaped	11
4049	Square Shaped	11
4051	Rectangle Shaped	9
4051-EE	IEEE 1394 I/O 4 Pin Connector	16
4052	D-Shaped	9
4053	D-Shaped	9
4054	J-Shaped	12
4055	Rectangle Shaped	10
4056	Rectangle Shaped	9
4057	Rectangle Shaped	10
4058	Rectangle Shaped	9
4060	D-Shaped	9
4062	Rectangle Shaped	10
4064	Rectangle Shaped	10
4065	Rectangle Shaped	10
4066	Rectangle Shaped	10
4070	Rectangle Shaped	10
4071	Rectangle Shaped	9
4078	D-Shaped	9
4079	Rectangle Shaped	9
4080	Rectangle Shaped	9
4080-FK	USB Port Connector	17
4081	Rectangle Shaped	10
4082	Rectangle Shaped	10
4083	Rectangle Shaped	10

Part #	Product	Page
<b>Fabric-Over-Foam (continued)</b>		
4084	Square Shaped	11
4085	D-Shaped Clip	11
4086	Rectangle Shaped	9
4087	Rectangle Shaped	10
4088	Rectangle Shaped	9
4089	Square Shaped	11
4090	D-Shaped	9
4091	Rectangle Shaped	9
4094	Rectangle Shaped	9
4096	Rectangle Shaped	9
4097	Knife Shaped	12
4098	Rectangle Shaped	10
4100	Rectangle Shaped	10
4105	D-Shaped	9
4106	Knife Shaped	12
4110	D-Shaped Clip	11
4111	D-Shaped Clip	11
4112	D-Shaped	9
4113	Rectangle Shaped	10
4114	Rectangle Shaped	10
4115	Rectangle Shaped	10
4117	J-Shaped	12
4120	D-Shaped	9
4121	D-Shaped Clip	11
4123	D-Shaped	9
4126	Rectangle Shaped	10
4131	Bell Shaped	12
4133	Rectangle Shaped	10
4134	D-Shaped	9
4136	Rectangle Shaped	10
4142	Rectangle Shaped	10
4143	Rectangle Shaped	9
4148	Rectangle Shaped	9
4150	P-Shaped	11
4157	Rectangle Shaped	9
4158	Rectangle Shaped	10
4160	Rectangle Shaped	9
4161	Rectangle Shaped	9
4163	Rectangle Shaped	9
4164	Rectangle Shaped	9
4164-EE	D-Sub Connector	15
4164-FE	SCSI + 50 Pin Connector	16
4164-FF	SCSI + 68 Pin Connector	17
4164-FH	RJ-11 Connector	16
4164-FW	D-Sub Connector	15
4164-FY	D-Sub Connector	15
4164-FZ	D-Sub Connector	15
4164-GA	D-Sub Connector	15

All dimensions shown are in inches (millimeters) unless otherwise specified.



Part #	Product	Page
<i>Fabric-Over-Foam (continued)</i>		
4168	C-Fold Shaped	11
4169	Rectangle Shaped	9
4170	Rectangle Shaped	9
4171	Rectangle Shaped	9
4172	Rectangle Shaped	10
4173	Rectangle Shaped	10
4176	Rectangle Shaped	10
4179	Rectangle Shaped	9
4181	D-Shaped	9
4182	Rectangle Shaped	10
4183	Oval Shaped	13
4184	D-Shape Shaped	9
4186	Rectangle Shaped	9
4189	Knife Shaped	12
4192	Rectangle Shaped	10
4194	Rectangle Shaped	10
4198	C-Fold Shaped	11
4199	Rectangle Shaped	9
4200	Rectangle Shaped	10
4201	Round Shaped	13
4202	D-Shaped	9
4203	Rectangle Shaped	10
4204	Square Shaped	11
4205	Knife Shaped	12
4206	Square Shaped	11
4208	Rectangle Shaped	9
4209	Rectangle Shaped	10
4210	Rectangle Shaped	10
4211	Rectangle Shaped	10
4212	Square Shaped	11
4215	Rectangle Shaped	9
4216	Rectangle Shaped	10
4219	Rectangle Shaped	9
4219-EB	USB Port 4 Pin Connector	15
4220	Rectangle Shaped	9
4222	Rectangle Shaped	10
4223	Rectangle Shaped	9
4224	Rectangle Shaped	10
4225	Rectangle Shaped	9
4226	Rectangle Shaped	10
4227	Rectangle Shaped	10
4228	D-Shaped	9
4231	Rectangle Shaped	9
4231-EE	I/O Connector	15
4233	Rectangle Shaped	10
4235	Rectangle Shaped	9
4237	Rectangle Shaped	10
4238	Rectangle Shaped	10
4239	Rectangle Shaped	10
4240	D-Shaped	9
4241	Rectangle Shaped	10

Part #	Product	Page
<i>Fabric-Over-Foam (continued)</i>		
4242	D-Shaped	9
4243	C-Fold Shaped	11
4245	Rectangle Shaped	9
4246	Rectangle Shaped	9
4247	Rectangle Shaped	10
4248	Rectangle Shaped	10
4249	Rectangle Shaped	10
4250	Rectangle Shaped	10
4251	Rectangle Shaped	10
4252	Rectangle Shaped	10
4253	Rectangle Shaped	10
4254	Rectangle Shaped	10
4255	Rectangle Shaped	10
4256	Rectangle Shaped	10
4257	Rectangle Shaped	10
4258	Rectangle Shaped	10
4259	Rectangle Shaped	9
4260	Rectangle Shaped	10
4262	Rectangle Shaped	10
4263	Rectangle Shaped	10
4264	Rectangle Shaped	10
4268	Rectangle Shaped	9
4269	D-Shaped	9
4270	Rectangle Shaped	9
4272	Rectangle Shaped	10
4273	Rectangle Shaped	9
4281	Rectangle Shaped	10
4283	D-Shaped	9
4285	Rectangle Shaped	10
4286	Rectangle Shaped	10
4293	Double Rectangle Shaped	13
4295	D-Shaped	9
4297	Rectangle Shaped	9
4299	Double D-Shaped	13
4300	Rectangle Shaped	9
4302	Rectangle Shaped	9
4315	Rectangle Shaped	10
4320	D-Shaped	9
4325	Rectangle Shaped	10
4330	Rectangle Shaped	10
4339	Rectangle Shaped	10
4A58	T-Shaped	13
4355	Rectangle Shaped	10
4356	D-Shaped	9
4358	D-Shaped	9
4359	Rectangle Shaped	10
4360	Rectangle Shaped	10
4361	Rectangle Shaped	10
4363	Rectangle Shaped	9
4365	Rectangle Shaped	10



Part #	Product	Page
<i>Fabric-Over-Foam (continued)</i>		
4368	D-Shaped	9
4370	Rectangle Shaped	10
4372	Round Shaped	13
4375	D-Shaped	9
4376	Rectangle Shaped	10
4379	Bell Shaped	12
4387	Bell Shaped	12
4389	Rectangle Shaped	10
4391	Rectangle Shaped	10
4392	Rectangle Shaped	10
4394	Rectangle Shaped	9
4404	Rectangle Shaped	9
4408	Rectangle Shaped	9
4410	Rectangle Shaped	9
4413	Rectangle Shaped Clip	11
4430	Rectangle Shaped	9
4455	Rectangle Shaped	9
4469	L-Shaped	13
4478	Oval Shaped	13
4499	Rectangle Shaped	10
4500	Rectangle Shaped	9
4501	Rectangle Shaped	9
4502	J-Shaped	12
4512	Rectangle Shaped	9
4513	Rectangle Shaped	10
4516	Rectangle Shaped	10
4517	Square Shaped	11
4518	Rectangle Shaped	9
4520	Square Shaped	11
4522	Square Shaped	11
4524	Rectangle Shaped	10
4525	Rectangle Shaped	10
4528	Rectangle Shaped	10
4529	C-Fold Shaped	11
4531	Rectangle Shaped	10
4532	Rectangle Shaped	9
4533	Rectangle Shaped	10
4534	L-Shaped	13
4536	Rectangle Shaped	10
4537	P-Shaped	11
4541	D-Shaped	9
4542	D-Shaped	9
4548	D-Shaped	9
4568	Rectangle Shaped	10
4569	Rectangle Shaped	9
4570	Rectangle Shaped	9
4571	Rectangle Shaped	10
4572	Rectangle Shaped	9
4573	Rectangle Shaped	9

Part #	Product	Page
<i>Fabric-Over-Foam (continued)</i>		
4575	Rectangle Shaped	10
4577	Rectangle Shaped	9
4579	Rectangle Shaped	9
4581	D-Shaped	9
4582	Rectangle Shaped	10
4583	Rectangle Shaped	10
4584	D-Shaped	9
4591	Rectangle Shaped	9
4593	C-Fold Shaped	11
4594	Rectangle Shaped	10
4596	Rectangle Shaped	9
4597	Rectangle Shaped	9
4599	Rectangle Shaped	9
4600	C-Fold Shaped	11
4601	Rectangle Shaped	10
4602	Rectangle Shaped	9
4603	Rectangle Shaped	10
4606	Rectangle Shaped	9
4607	D-Shaped	9
4609	D-Shaped	9
4610	Rectangle Shaped	10
4612	Rectangle Shaped	10
4615	Rectangle Shaped	10
4619	Rectangle Shaped	10
4626	Rectangle Shaped	9
4628	Rectangle Shaped	9
4629	Rectangle Shaped	9
4630	Bell Shaped	12
4632	Rectangle Shaped	10
4633	Bell Shaped	12
4649	Rectangle Shaped	10
4650	Rectangle Shaped	10
4674	Rectangle Shaped	10
4675	Rectangle Shaped	10
4677	Rectangle Shaped	9
4679	Rectangle Shaped	9
4686	Rectangle Shaped	10
4687	Rectangle Shaped	10
4688	Rectangle Shaped	9
4692	D-Shaped	9
4693	Rectangle Shaped	10
4694	Rectangle Shaped	10
4695	Square Shaped	11
4697	C-Fold Shaped	11
4698	Rectangle Shaped	10
4699	P-Shaped	11
4701	Rectangle Shaped	10
4702	Rectangle Shaped	10
4703	C-Fold Shaped	11



Part #	Product	Page
<b>Fabric-Over-Foam</b> (continued)		
4704	Rectangle Shaped	10
4705	Rectangle Shaped	10
4740	Rectangle Shaped	10
4741	Rectangle Shaped	10
4742	D-Shaped	9
4743	D-Shaped	9
4744	Rectangle Shaped	10
4786	Rectangle Shaped	10
4787	D-Shaped	9
4788	Rectangle Shaped	10
4789	D-Shaped	9
4791	Rectangle Shaped	10
4792	P-Shaped	11
4795	Rectangle Shaped	10
4796	Knife Shaped	12
4797	Knife Shaped	12
4798	Rectangle Shaped	10
4799	Rectangle Shaped	10
4801	Rectangle Shaped	10
4850	Rectangle Shaped	9
4900	Rectangle Shaped	10
4902	Rectangle Shaped	10
4903	Rectangle Shaped	10
4906	D-Shaped	9
4907	Rectangle Shaped	9
4912	D-Shaped	9
4913	Rectangle Shaped Clip	11
4914	Rectangle Shaped	10

**Conductive Foam**

5010	Backplane Profile	25
5015	Rectangle Shaped	22
5023	Rectangle Shaped	22
5037-EB	USB Port Connector	24
5044	Backplane Profile	25
5068-EA	USB Port 4 Pin Connector	23
5076	Rectangle Shaped	22
5078	Rectangle Shaped	22
5092	Rectangle Shaped	22
5100	Rectangle Shaped	22
5104	Rectangle Shaped	22
5125	Rectangle Shaped	22
5151	Backplane Profile	25
5152	Backplane Profile	25
5157	Rectangle Shaped	22
5164-EA	D-Sub Connector	23
5164-EE	D-Sub Connector	23
5164-EF	D-Sub Connector	23
5167	Rectangle Shaped	22
5168	Rectangle Shaped	22
5169	Rectangle Shaped	22

Part #	Product	Page
<b>Conductive Foam</b> (continued)		
5174	Rectangle Shaped	20
5176	Rectangle Shaped	20
5191	Rectangle Shaped	20
5213	Backplane Profile	23
5214	Rectangle Shaped	20
5219	Rectangle Shaped	20
5220	Rectangle Shaped	20
5221	Rectangle Shaped	20
5233	Rectangle Shaped	20
5239-EG	I/O Connector	22
5241	Backplane Profile	23
5242	Backplane Profile	23
5248	Backplane Profile	23
5249	Backplane Profile	23
5261	Rectangle Shaped	20
5262	Rectangle Shaped	20
5264	Backplane Profile	23
5268	Backplane Profile	23
5269	Backplane Profile	23
5286	Rectangle Shaped	20
5308	Rectangle Shaped	20
5997	Rectangle Shaped	20
5999	Backplane Profile	23

**Conductive Tape**

3027-532C	MRI "A" Fabric	29
8274-0050-76	Tin Plated Cu Foil Tape with Release Mask	30
8274-0075-76	Tin Plated Cu Foil Tape with Release Mask	30
8274-0100-76	Tin Plated Cu Foil Tape with Release Mask	30



Laird Technologies is a fully integrated manufacturer of profile and Input/Output (I/O) EMI shielding gaskets. The metallized Fabric-Over-Foam product line has been expanded greatly due to our committed efforts in new product development and meeting or surpassing regulatory requirements.

This catalog is designed to provide helpful information to engineers on our expanded product line. In this section, you will find benefits for Fabric-Over-Foam gaskets, material options and an extensive list of profile and I/O sizes and configurations.

Laird Technologies specializes in quick turnaround of custom shapes and sizes of EMI shielding gaskets. If you don't find exactly what you need, our engineers will help you design the right solution to your shielding problem.

A sampling for standard profiles are shown; custom configurations and sizes can be designed to meet your specific requirements. Profiles are shown in ascending order by height (starting on page 9).

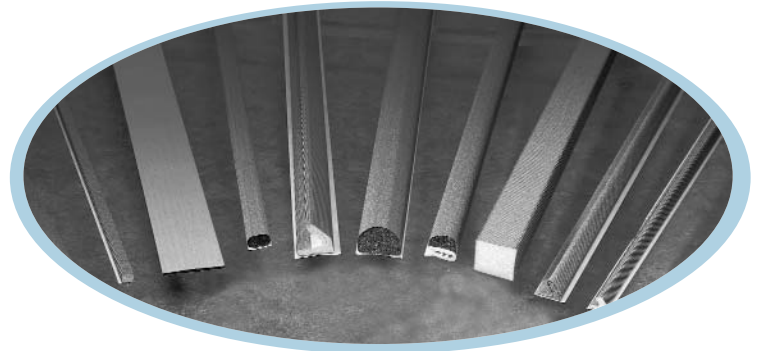

## Benefits of Fabric-Over-Foam Gaskets

- Shielding effectiveness of >100dB across a wide spectrum of frequencies (MIL-STD 285 mod.) (see figure 1).
- Extremely low compression forces allow for use of lighter materials (see figure 2).
- Low Surface Resistivity of <0.07 ohms/square provides improved conductivity (ASTM F390).
- Wide range of flame retardant gaskets available (UL recognized per UL94 V0 or UL94 HB). UL yellow cards available on request.
- Abrasion resistant metallized fabrics show virtually no degradation in shielding performance after 1,000,000 cycles (ASTM D3886).
- Urethane & Thermoplastic Elastomer (TPE) cores provide low compression set ensuring long-term reliability of gasket performance. Contact Engineering for profile specific data.
- Service temperatures from -40°F to 158°F (-40°C to 70°C).
- Available in Nickel/Copper (Ni/Cu) and Tin/Copper (Sn/Cu) to ensure galvanic compatibility with a wide variety of host materials. Both versions display no significant performance degradation after environmental exposure per the Accelerated Aging Test (ASTM B845).
- Prototype samples can be provided quickly utilizing laser technology, CAD/CAM equipment, and customer supplied drawings in DWG®, DXF®, IGS, PRT®, DRW®, STP®, and CT® file formats.

- Profile and I/O gaskets are available with a variety of pressure sensitive adhesive (PSA) tapes, including Easy Peel® with extra wide release liner to facilitate quick assembly.
- Profile gaskets can be cut to specified lengths, kiss-cut on release liner, or mitered to form frame configurations.
- Fabric-Over-Foam gaskets are RoHS compliant.

Figure 1

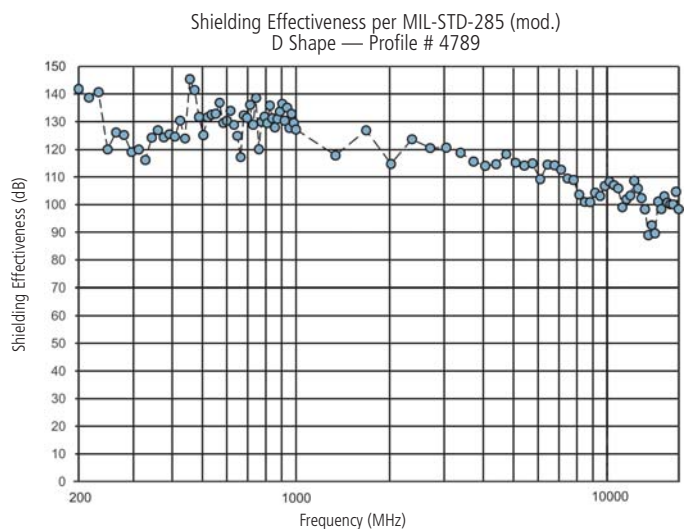





Fabric\*

Fabric Types	Metal Coating	Conductivity (ASTM F390)	Application	Benefits
Ripstop	Ni/Cu, Sn/Cu	≤ 0.07 ohms/square	I/O or Profile Gaskets	Complex Shapes, Flame Retardant, Shear Resistance
Taffeta	Ni/Cu	≤ 0.07 ohms/square	Profile Gaskets	Complex Shapes, Flame Retardant
Knit Mesh	Ni/Cu	≤ 0.1 ohms/square	I/O Gaskets	Low Cost, Flame Retardant

Pressure Sensitive Adhesive\*

Pressure Sensitive Adhesive	180° Peel Strength on Stainless Steel (ASTM D-3330)	Application	Benefits
3M™ 9485 or equivalent	75 oz/in (82N/100mm)	High Tack, Shear Resistant	High Peel Strength and Temperature Resistant
Nitto D5052 or equivalent	87 oz / in (95N/100mm)	High Tack, Shear Resistant	High Cohesive Strength, High Peel Strength and Temperature Resistant

Other Pressure Sensitive Adhesives can be provided. Contact Engineering to discuss requirements.

Foam\*

Foam Types	Compression Set (ASTM D 3574)	Color	Application	Benefits
Urethane	5 to 10%	Charcoal or Tan	I/O or Profile Gaskets	Flame Retardant, Low Compression Gasket, Complex Shapes
Thermoplastic Elastomer (TPE)	< 20%	Off White	Profile Gaskets	Complex Shapes, Flame Retardant

The recommended operating compression for Fabric-Over-Foam EMI Gaskets will vary depending on the shape and size of the particular gasket.

Typically, D-Shaped, Rectangular Shaped, and Square Shaped Fabric-Over-Foam EMI Gaskets should be compressed between 30% and 50% of the foam height.

Similarly, C-Shaped Fabric-Over-Foam EMI Gaskets should typically be compressed between 50% and 75% of the gasket height.

Force Displacement Resistance (FDR) graphs are available upon request. Please contact Engineering when unsure.

\* Certain combinations of materials may not be available for all Profiles or I/Os. Please consult the Engineering Department at Laird Technologies when unsure.

Figure 2

Force Displacement Resistance Comparing Different Foams Urethane Foam & Thermoplastic Elastomer (TPE Foam)

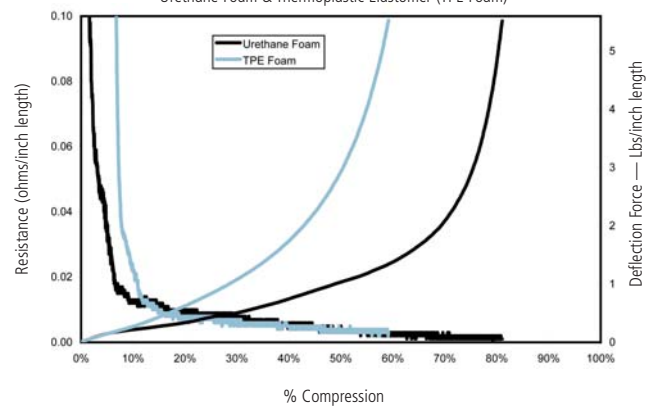

Diverse Assembly Options

Multiple attachment options provide a variety of ways to install critical EMI products. Pressure Sensitive Adhesive (PSA) has been complemented with the Easy Peel® release liner, and rigid clip configurations. These mechanical attachment options enable you to take advantage of existing tooling on doors and enclosures as well as offer alternate attachment methods to better meet design requirements.

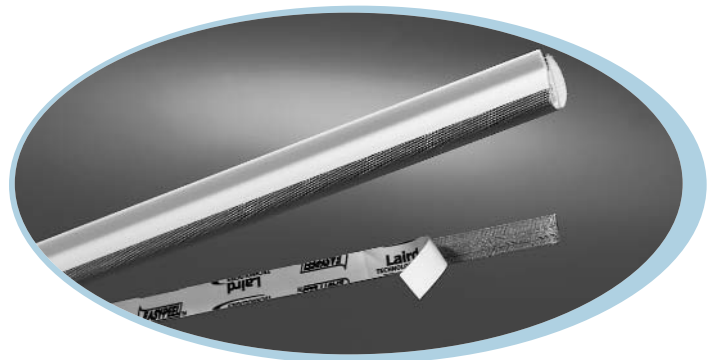

Profile Gasket Tolerances

Profile	Tolerance Inches (Millimeters)
Height & Width	± .020 (0.5)
Length Inches (Millimeters)	Tolerance Inches (Millimeters)
1 to 6 (25.4 – 152.4)	± .030 (0.8)
6 to 11 (152.4 – 279.4)	± .050 (1.3)
11 to 48 (279.4 – 1219.2)	± .100 (2.5)
48 to 70 (1219.2 – 1778.0)	± .187 (4.7)
70 to 96 (1778.0 – 2438.4)	± .250 (6.4)

For parts shorter than 1 inch (25.4mm), or longer than 96" (2438.4mm), please consult Engineering for tolerances. See back cover for contact information.

All dimensions shown are in inches (millimeters) unless otherwise specified.



### D-Shaped

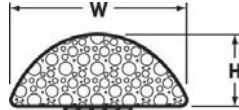

Profile Number	inches (mm) H	inches (mm) W
4584	0.040 (1.0)	0.150 (3.8)
4320	0.050 (1.3)	0.140 (3.6)
4541	0.050 (1.3)	0.250 (6.4)
4358	0.060 (1.5)	0.098 (2.5)
4184	0.060 (1.5)	0.150 (3.8)
4548	0.060 (1.5)	0.250 (6.4)
4356	0.070 (1.8)	0.180 (4.6)
4052	0.080 (2.0)	0.080 (2.0)
4283	0.080 (2.0)	0.157 (4.0)
4181	0.080 (2.0)	0.394 (10.0)
4053	0.090 (2.3)	0.090 (2.3)
4912	0.090 (2.3)	0.150 (3.8)
4375	0.094 (2.4)	0.200 (5.1)
4240	0.100 (2.5)	0.300 (7.6)
4742	0.120 (3.0)	0.150 (3.8)
4202	0.120 (3.0)	0.250 (6.4)
4078	0.120 (3.0)	0.360 (9.1)
4090	0.125 (3.2)	0.090 (2.3)

Profile Number	inches (mm) H	inches (mm) W
4906	0.130 (3.3)	0.188 (4.8)
4692	0.140 (3.6)	0.250 (6.4)
4228	0.150 (3.8)	0.150 (3.8)
4123	0.150 (3.8)	0.354 (9.0)
4112	0.158 (4.0)	0.433 (11.0)
4120	0.160 (4.1)	0.240 (6.1)
4295	0.170 (4.3)	0.250 (6.4)
4609	0.180 (4.6)	0.400 (10.2)
4787	0.200 (5.1)	0.250 (6.4)
4134	0.197 (5.0)	0.394 (10.0)
4607	0.200 (5.1)	0.480 (12.2)
4242	0.250 (6.4)	0.250 (6.4)
4542	0.248 (6.3)	0.291 (7.4)
4789	0.250 (6.4)	0.375 (9.5)
4368	0.299 (7.6)	0.272 (6.9)
4105	0.375 (9.5)	0.500 (12.7)
4060	0.500 (12.7)	0.500 (12.7)

### Rectangle Shaped

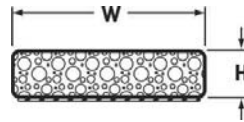

Profile Number	inches (mm) H	inches (mm) W
4570	0.015 (0.4)	0.200 (5.1)
4577	0.015 (0.4)	0.276 (7.0)
4572	0.015 (0.4)	0.394 (10.0)
4300	0.017 (0.4)	0.826 (21.0)
4058	0.020 (0.5)	0.157 (4.0)
4569	0.020 (0.5)	0.196 (5.0)
4500	0.020 (0.5)	1.217 (30.9)
4501	0.020 (0.5)	1.970 (50.0)
4850	0.030 (0.8)	0.900 (22.9)
4245	0.040 (1.0)	0.120 (3.0)
4223	0.040 (1.0)	0.157 (4.0)
4220	0.040 (1.0)	0.200 (5.1)
4404	0.040 (1.0)	0.236 (6.0)
4215	0.040 (1.0)	0.275 (7.0)
4208	0.040 (1.0)	0.395 (10.0)
4219	0.040 (1.0)	0.510 (13.0)
4259	0.040 (1.0)	0.600 (15.2)
4677	0.040 (1.0)	0.709 (18.0)
4532	0.040 (1.0)	0.750 (19.1)
4597	0.040 (1.0)	0.900 (22.9)
4297	0.040 (1.0)	1.000 (25.4)
4363	0.040 (1.0)	1.126 (28.6)
4179	0.040 (1.0)	1.431 (36.3)
4512	0.040 (1.0)	1.640 (41.7)
4270	0.040 (1.0)	1.770 (45.0)
4573	0.040 (1.0)	1.840 (46.7)
4394	0.040 (1.0)	3.300 (83.8)
4246	0.050 (1.3)	0.090 (2.3)
4088	0.050 (1.3)	0.220 (5.6)
4086	0.060 (1.5)	0.850 (21.6)
4273	0.060 (1.5)	0.125 (3.2)
4056	0.060 (1.5)	0.200 (5.1)
4157	0.060 (1.5)	0.280 (7.1)
4629	0.060 (1.5)	0.394 (10.0)
4051	0.060 (1.5)	0.500 (12.7)

Profile Number	inches (mm) H	inches (mm) W
4455	0.060 (1.5)	0.551 (14.0)
4430	0.060 (1.5)	0.591 (15.0)
4626	0.060 (1.5)	0.608 (15.4)
4606	0.060 (1.5)	0.620 (15.7)
4579	0.060 (1.5)	0.650 (16.5)
4164	0.060 (1.5)	0.750 (19.1)
4170	0.060 (1.5)	0.866 (22.0)
4225	0.060 (1.5)	0.900 (22.9)
4080	0.060 (1.5)	1.000 (25.4)
4599	0.060 (1.8)	1.063 (27.0)
4518	0.060 (1.5)	1.235 (31.4)
4079	0.060 (1.5)	1.330 (33.8)
4161	0.060 (1.5)	1.370 (34.8)
4163	0.060 (1.5)	1.400 (35.6)
4591	0.060 (1.5)	1.455 (37.0)
4091	0.060 (1.5)	1.525 (38.7)
4628	0.060 (1.5)	1.575 (40.0)
4231	0.060 (1.5)	1.615 (41.0)
4679	0.060 (1.5)	1.693 (43.0)
4408	0.060 (1.5)	1.740 (44.2)
4148	0.060 (1.5)	1.878 (47.7)
4169	0.060 (1.5)	1.900 (48.3)
4160	0.060 (1.5)	2.305 (58.5)
4235	0.060 (1.5)	2.520 (64.0)
4596	0.060 (1.5)	3.091 (78.5)
4907	0.060 (1.5)	3.780 (96.0)
4071	0.062 (1.6)	0.300 (7.6)
4171	0.062 (1.6)	0.870 (22.1)
4143	0.062 (1.6)	2.000 (50.8)
4268	0.070 (1.8)	0.160 (4.1)
4302	0.071 (1.8)	0.551 (14.0)
4199	0.070 (1.8)	0.650 (16.5)
4410	0.070 (1.8)	1.063 (27.0)
4688	0.079 (2.0)	0.118 (3.0)
4392	0.079 (2.0)	0.354 (9.0)
4094	0.080 (2.0)	0.160 (4.1)
4186	0.080 (2.0)	0.200 (5.1)
4602	0.080 (2.0)	0.236 (6.0)
4096	0.080 (2.0)	0.275 (7.0)

All dimensions shown are in inches (millimeters) unless otherwise specified.

continued



# METALLIZED CONDUCTIVE PRODUCTS FABRIC-OVER-FOAM PROFILE SELECTION GUIDE

Profile Number	inches (mm) H	inches (mm) W
4650	0.080 (2.0)	0.295 (7.5)
4601	0.080 (2.0)	0.315 (8.0)
4357	0.080 (2.0)	0.394 (10.0)
4182	0.080 (2.0)	0.400 (10.2)
4675	0.080 (2.0)	0.535 (13.6)
4359	0.080 (2.0)	0.710 (18.0)
4571	0.080 (2.0)	0.787 (20.0)
4200	0.080 (2.0)	0.827 (21.0)
4361	0.080 (2.0)	0.900 (22.9)
4325	0.080 (2.0)	0.984 (25.0)
4194	0.080 (2.0)	1.126 (28.6)
4389	0.080 (2.0)	1.259 (32.0)
4315	0.080 (2.0)	1.345 (34.2)
4531	0.080 (2.0)	1.550 (39.4)
4263	0.080 (2.0)	1.615 (41.0)
4262	0.080 (2.0)	1.736 (44.1)
4260	0.080 (2.0)	1.842 (46.8)
4355	0.080 (2.0)	5.340 (135.6)
4339	0.090 (2.3)	0.200 (5.1)
4903	0.090 (2.3)	0.535 (13.6)
4248	0.090 (2.3)	1.060 (26.9)
4254	0.090 (2.3)	1.370 (34.8)
4255	0.090 (2.3)	1.655 (42.0)
4256	0.090 (2.3)	1.700 (43.2)
4801	0.100 (2.5)	0.265 (6.7)
4082	0.100 (2.5)	0.375 (9.5)
4612	0.100 (2.5)	0.500 (12.7)
4133	0.100 (2.5)	0.354 (9.0)
4285	0.100 (2.5)	1.330 (33.8)
4582	0.100 (2.5)	1.500 (38.1)
4330	0.100 (2.5)	1.625 (41.3)
4083	0.110 (2.8)	0.240 (6.1)
4042	0.118 (3.0)	0.125 (3.2)
4619	0.118 (3.0)	0.197 (5.0)
4272	0.118 (3.0)	0.315 (8.0)
4286	0.118 (3.0)	0.394 (10.0)
4583	0.118 (3.0)	0.787 (20.0)
4126	0.118 (3.0)	1.717 (43.6)
4209	0.120 (3.0)	0.155 (3.9)
4210	0.120 (3.0)	0.355 (9.0)
4264	0.120 (3.0)	0.750 (19.1)
4536	0.120 (3.0)	1.551 (39.4)
4788	0.125 (3.2)	0.250 (6.4)
4694	0.125 (3.2)	0.500 (12.7)
4065	0.125 (3.2)	0.600 (15.2)
4247	0.125 (3.2)	0.700 (17.8)
4376	0.125 (3.2)	0.720 (18.3)
4064	0.125 (3.2)	1.000 (25.4)
4603	0.125 (3.2)	1.125 (28.6)
4066	0.125 (3.2)	1.250 (31.8)
4158	0.125 (3.2)	1.400 (35.6)
4239	0.125 (3.2)	1.615 (41.0)
4238	0.125 (3.2)	1.850 (47.0)
4693	0.130 (3.3)	0.190 (4.8)
4062	0.130 (3.3)	0.380 (9.7)
4694	0.130 (3.3)	0.500 (12.7)
4632	0.125 (3.2)	1.625 (41.3)
4575	0.125 (3.2)	2.000 (50.8)
4615	0.138 (3.5)	0.197 (5.0)
4594	0.138 (3.5)	0.350 (8.9)
4525	0.140 (3.6)	0.512 (13.0)
4203	0.150 (3.8)	0.100 (2.5)
4047	0.150 (3.8)	0.500 (12.7)
4533	0.156 (4.0)	0.630 (16.0)

Profile Number	inches (mm) H	inches (mm) W
4799	0.156 (4.0)	0.650 (16.5)
4914	0.156 (4.0)	0.709 (18.0)
4499	0.157 (4.0)	0.197 (5.0)
4741	0.157 (4.0)	0.256 (6.5)
4055	0.157 (4.0)	0.315 (8.0)
4516	0.157 (4.0)	0.354 (9.0)
4791	0.157 (4.0)	0.394 (10.0)
4098	0.157 (4.0)	0.591 (15.0)
4704	0.158 (4.0)	0.236 (6.0)
4241	0.160 (4.1)	0.200 (5.1)
4253	0.160 (4.1)	0.280 (7.1)
4114	0.158 (4.0)	0.433 (11.0)
4115	0.160 (4.1)	0.590 (15.0)
4249	0.160 (4.1)	0.790 (20.1)
4257	0.160 (4.1)	0.880 (22.4)
4252	0.160 (4.1)	0.985 (25.0)
4250	0.160 (4.1)	1.375 (34.9)
4251	0.160 (4.1)	1.700 (43.2)
4142	0.177 (4.5)	0.354 (9.0)
4370	0.180 (4.6)	2.000 (50.8)
4902	0.196 (5.0)	0.315 (8.0)
4258	0.190 (4.8)	1.625 (41.3)
4698	0.195 (5.0)	0.130 (3.3)
4211	0.195 (5.0)	0.395 (10.0)
4674	0.197 (5.0)	0.512 (13.0)
4360	0.197 (5.0)	0.591 (15.0)
4281	0.200 (5.1)	3.900 (99.1)
4365	0.216 (5.5)	0.394 (10.0)
4100	0.216 (5.5)	0.500 (12.7)
4786	0.217 (5.5)	0.394 (10.0)
4528	0.217 (5.5)	0.709 (18.0)
4087	0.225 (5.7)	0.218 (5.5)
4701	0.250 (6.4)	0.375 (9.5)
4795	0.250 (6.4)	0.500 (12.7)
4798	0.250 (6.4)	0.600 (15.2)
4226	0.250 (6.4)	0.750 (19.1)
4224	0.250 (6.4)	1.000 (25.4)
4705	0.256 (6.5)	0.236 (6.0)
4740	0.256 (6.5)	0.394 (10.0)
4649	0.275 (7.0)	0.394 (10.0)
4568	0.275 (7.0)	0.511 (13.0)
4113	0.276 (7.0)	0.433 (11.0)
4227	0.283 (7.2)	1.180 (30.0)
4222	0.295 (7.5)	0.591 (15.0)
4237	0.295 (7.5)	1.500 (38.1)
4057	0.315 (8.0)	0.157 (4.0)
4687	0.315 (8.0)	0.236 (6.0)
4216	0.315 (8.0)	0.395 (10.0)
4610	0.335 (8.5)	0.394 (10.0)
4702	0.375 (9.5)	0.250 (6.4)
4081	0.375 (9.5)	0.500 (12.7)
4070	0.375 (9.5)	0.750 (19.1)
4192	0.375 (9.5)	1.000 (25.4)
4176	0.394 (10.0)	0.787 (20.0)
4513	0.413 (10.5)	0.394 (10.0)
4173	0.413 (10.5)	0.512 (13.0)
4524	0.452 (11.5)	0.472 (12.0)
4391	0.500 (13.0)	0.984 (25.0)
4172	0.591 (15.0)	0.394 (10.0)
4233	0.600 (15.2)	1.000 (25.4)
4136	0.670 (17.0)	0.591 (15.0)
4900	0.700 (17.8)	0.500 (12.7)
4686	0.709 (18.0)	0.394 (10.0)
4744	0.787 (20.0)	0.580 (14.7)

All dimensions shown are in inches (millimeters) unless otherwise specified.



### D-Shaped Clip

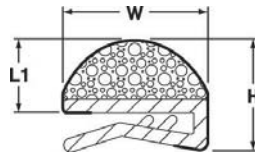

Profile Number	inches (mm) H	inches (mm) W	inches (mm) L1
4110	0.203 (5.2)	0.250 (6.4)	0.125 (3.2)
4111	0.243 (6.2)	0.250 (6.4)	0.165 (4.2)
4039	0.304 (7.7)	0.480 (12.2)	0.195 (5.0)
4033	0.350 (8.9)	0.480 (12.2)	0.240 (6.1)
4121	0.358 (9.1)	0.250 (6.4)	0.280 (7.1)
4040	0.410 (10.4)	0.480 (12.2)	0.300 (7.6)
4038	0.430 (10.9)	0.490 (12.4)	0.310 (7.9)
4043	0.430 (10.9)	0.490 (12.4)	0.310 (7.9)
4085	0.430 (10.9)	0.490 (12.4)	0.310 (7.9)
4041	0.568 (14.4)	0.480 (12.2)	0.458 (11.6)

### Rectangle Shaped Clip

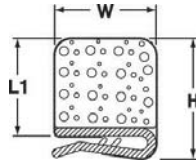

Profile Number	inches (mm) H	inches (mm) W	inches (mm) L1
4913	0.440 (11.2)	0.375 (9.5)	0.360 (9.1)
4413	0.485 (12.3)	0.390 (9.9)	0.405 (10.3)

### C-Fold Shaped

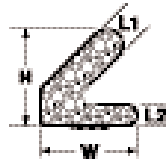

Profile Number	inches (mm) H	inches (mm) W	inches (mm) L1	inches (mm) L2
4593	0.250 (6.4)	0.280 (7.1)	0.125 (3.2)	0.060 (1.5)
4168	0.315 (8.0)	0.315 (8.0)	0.080 (2.0)	0.080 (2.0)
4198	0.385 (9.8)	0.420 (10.7)	0.115 (2.9)	0.060 (1.5)
4243	0.400 (10.2)	0.430 (10.9)	0.125 (3.2)	0.060 (1.5)
4600	0.415 (10.5)	0.450 (11.4)	0.135 (3.4)	0.650 (1.7)
4529	0.465 (11.8)	0.420 (10.7)	0.115 (2.9)	0.060 (1.5)
4697	0.675 (17.1)	0.590 (15.0)	0.165 (4.2)	0.156 (4.0)
4703	0.947 (24.1)	0.550 (14.0)	0.157 (4.0)	0.170 (4.3)

### Square Shaped

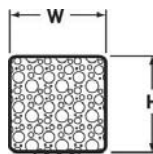

Profile Number	inches (mm) H	inches (mm) W
4520	0.080 (2.0)	0.080 (2.0)
4046	0.118 (3.0)	0.118 (3.0)
4522	0.157 (4.0)	0.157 (4.0)
4212	0.195 (5.0)	0.195 (5.0)
4048	0.236 (6.0)	0.236 (6.0)
4049	0.250 (6.4)	0.250 (6.4)
4695	0.375 (9.5)	0.375 (9.5)
4206	0.395 (10.0)	0.395 (10.0)
4084	0.500 (12.7)	0.500 (12.7)
4204	0.670 (17.0)	0.670 (17.0)
4517	0.750 (19.1)	0.750 (19.1)
4089	0.787 (20.0)	0.787 (20.0)

### P-Shaped

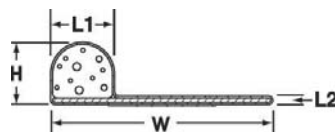

Profile Number	inches (mm) H	inches (mm) W	inches (mm) L1	inches (mm) L2
4150	0.118 (3.0)	0.520 (13.2)	0.242 (6.1)	0.020 (.50)
4699	0.145 (3.7)	0.520 (13.2)	0.150 (3.8)	0.020 (.50)
4792	0.200 (5.1)	0.480 (12.2)	0.170 (4.3)	0.090 (2.3)
4537	0.374 (9.5)	0.887 (22.5)	0.500 (13.0)	0.051 (1.0)

All dimensions shown are in inches (millimeters) unless otherwise specified.



### Knife Shaped

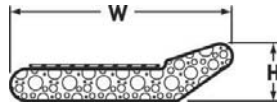

Profile Number	inches (mm) H	inches (mm) W
4797	0.106 (2.7)	0.445 (11.3)
4097	0.106 (2.7)	0.315 (8.0)
4796	0.110 (2.8)	0.450 (11.4)
4205	0.250 (6.4)	0.750 (19.1)
4106	0.312 (7.9)	0.707 (18.0)
4189	0.350 (8.9)	0.750 (19.1)

### J-Shaped

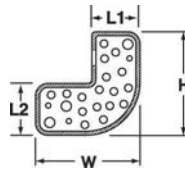

Profile Number	inches (mm) H	inches (mm) W	inches (mm) L1	inches (mm) L2
4117	0.130 (3.3)	0.130 (3.3)	0.060 (1.5)	0.065 (1.7)
4054	0.209 (5.3)	0.130 (3.3)	0.063 (1.6)	0.071 (1.8)
4502	0.400 (10.2)	0.300 (7.6)	0.175 (4.4)	0.140 (3.6)

### Bell Shaped

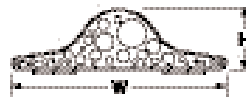

Profile Number	inches (mm) H	inches (mm) W
4630	0.070 (1.8)	0.180 (4.6)
4379	0.070 (1.8)	0.564 (14.3)
4387	0.080 (2.0)	0.675 (17.1)
4633	0.100 (2.5)	0.300 (7.6)
4131	0.140 (3.6)	0.500 (12.7)

### C-Fold with Clip

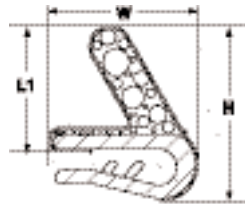

Profile Number	inches (mm) H	inches (mm) W	inches (mm) L1
4032	0.335 (8.5)	0.287 (7.3)	0.240 (6.1)

All dimensions shown are in inches (millimeters) unless otherwise specified.



Double D Shaped

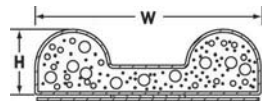

Profile Number	inches (mm) H	inches (mm) W
4299	0.110 (2.8)	0.382 (9.7)

Double Rectangle Shaped



Profile Number	inches (mm) H	inches (mm) W
4293	0.080 (2.0)	1.830 (46.5)

L-Shaped

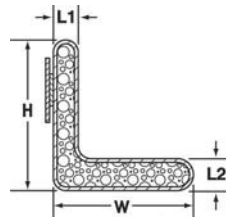

Profile Number	inches (mm) H	inches (mm) W	inches (mm) L1	inches (mm) L2
4469	0.216 (5.5)	0.354 (9.0)	.138 (3.5)	.118 (3.0)
4534	0.591 (15)	0.551 (14.0)	.098 (2.5)	.126 (3.2)

Oval Shaped

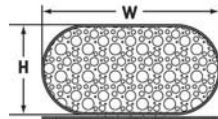

Profile Number	inches (mm) H	inches (mm) W
4478	0.138 (3.5)	0.197 (5.0)
4183	0.250 (6.4)	0.500 (12.7)

Round Shaped

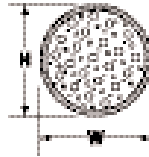

Profile Number	inches (mm) H	inches (mm) W
4201	0.100 (2.5)	0.100 (2.5)
4372	0.125 (3.2)	0.125 (3.2)

T-Shaped

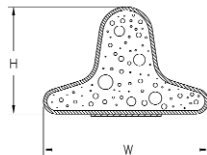

Profile Number	inches (mm) H	inches (mm) W
4A58	0.152 (3.9)	0.235 (6.0)



The following pages show examples of standard I/O gaskets used in computer and telecommunication applications. If you have different requirements, our Engineering Department will design your gaskets to the specifications you supply. We will design your I/O from a fully detailed print, drawing file, or the actual panel to which the gasket is to be applied.

#### I/O Gasket Tolerances

- Height tolerance:**  $\pm .020"$  ( $\pm 0.5\text{mm}$ )
- Width tolerance:**  $\pm .020"$  ( $\pm 0.5\text{mm}$ )
- Length tolerance:**  $\pm .020"$  ( $\pm 0.5\text{mm}$ )
- Cutout tolerance:**  $\pm .020"$  ( $\pm 0.5\text{mm}$ )

If different tolerances are required, please consult Engineering. See back cover for contact information.

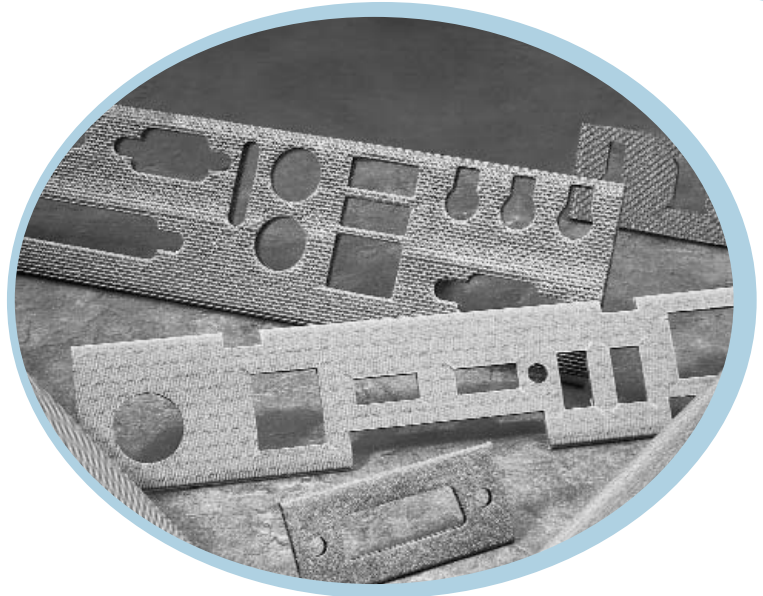

### Basic I/O Gasket Design

- 1 Space between required cutouts should match or exceed 0.060" (1.5mm).
- 2 Distance from the edge of a cutout should be at least 0.060" (1.5mm) from the edge of the gasket. In most cases, a slot can be used in place of a hole that is positioned too close to the gasket edge.
- 3 All cutouts and locations are designed customer specifications.
- 4 Pressure Sensitive Adhesive (PSA) and Extended Release Liner (ERL) can be applied in parallel with the long edge of the gasket.

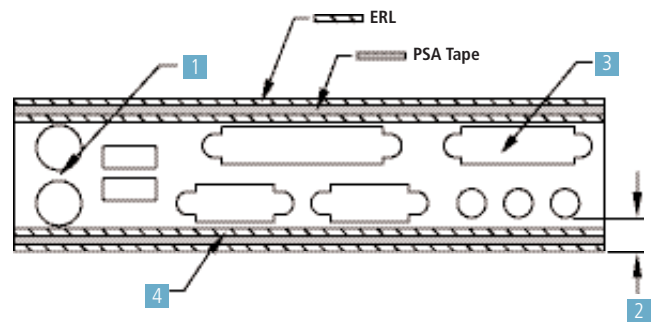

The recommended operating compression for Fabric-Over-Foam EMI gaskets will vary depending on the shape and size of the particular gasket. Typically, I/O gaskets should be compressed between 30% and 50% of the foam height.

All dimensions shown are in inches (millimeters) unless otherwise specified.



## D-Sub Connector Series

Part No.	#Pins	A	B	C	D	E	Usage
4164-EE	9	1.320 (33.5)	.984 (25.0)	.650 (16.5)	.155 (3.9)	.310 (8.0)	Serial, Mouse, Com, Port
4164-FW	11, 15	1.650 (41.9)	1.310 (33.3)	.971 (24.7)	.155 (3.9)	.310 (7.9)	VGA, Game, Multi-media, Serial Port
4164-FY	25	2.204 (56.0)	1.865 (47.4)	1.500 (38.1)	.155 (3.9)	.310 (7.9)	Parallel, Serial, Scanner, Printers
4164-FZ	37	2.859 (72.6)	2.535 (64.4)	2.200 (55.9)	.155 (3.9)	.310 (7.9)	Serial Port
4164-GA	50	2.750 (69.9)	2.406 (61.1)	2.064 (52.4)	.211 (5.4)	.422 (10.7)	Serial Port

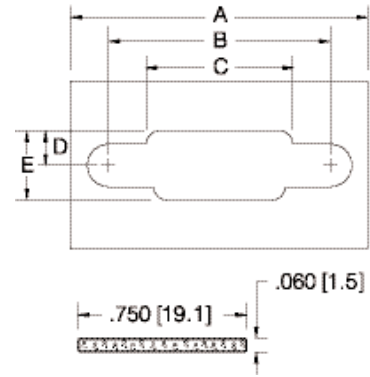

## USB Port 4 Pin Connector, Part Number 4219-EB

Usage: Multi-use, hot plug-and-play

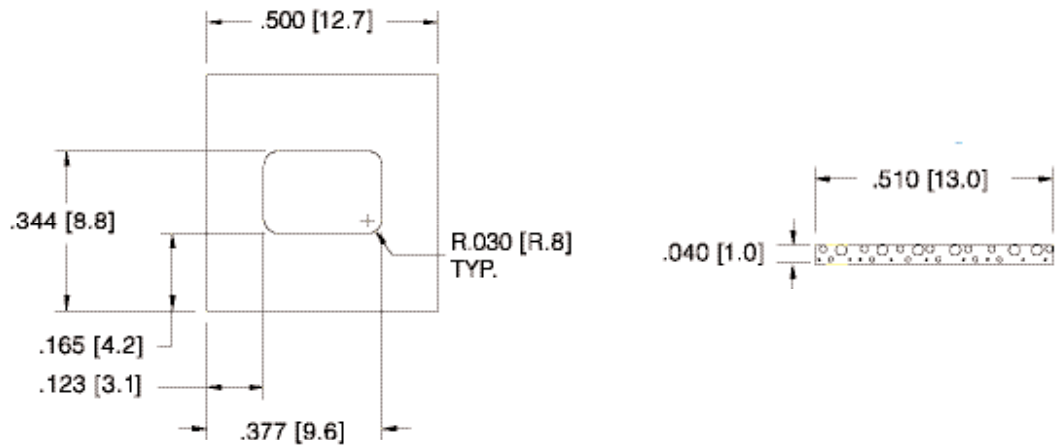

## I/O Connector, Part Number 4231-EE

Usage: Standard PC Motherboard/Main Board (MB) I/O Shield

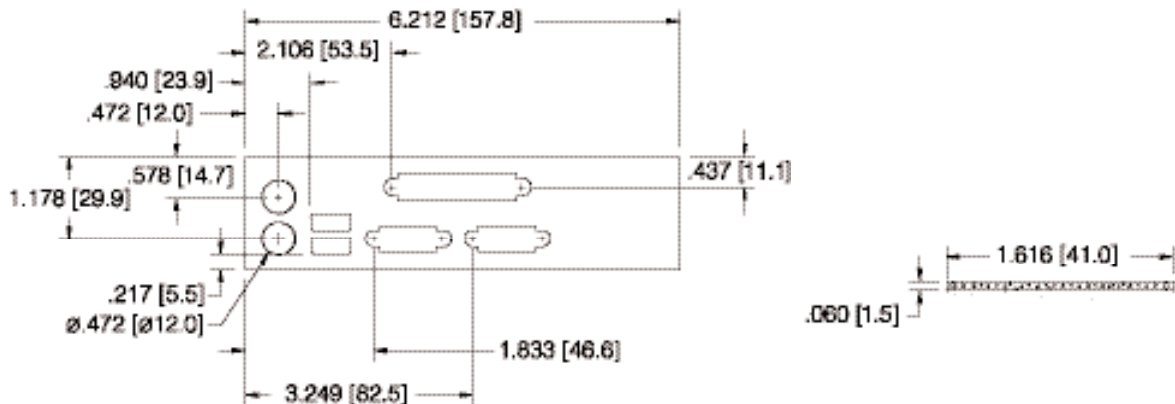

All dimensions shown are in inches (millimeters) unless otherwise specified.





### IEEE 1394 I/O 4 Pin Connector, Part Number 4051-EE

Usage: Plug-and-Play Serial Port (Digital Cameras, Printers, Keyboards, Mouse)

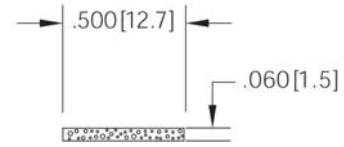
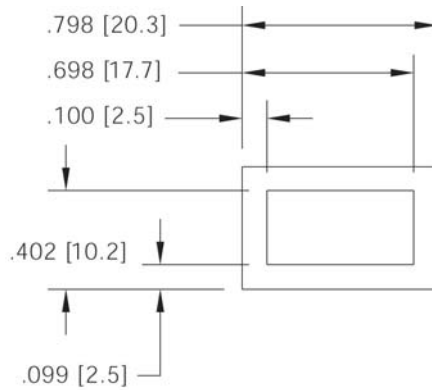

### SCSI + 50 Pin Connector, Part Number 4164-FE

Usage: Peripheral, Hard Disk, CD-ROM

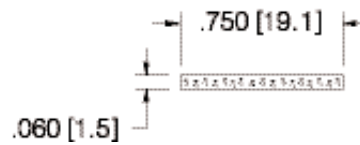
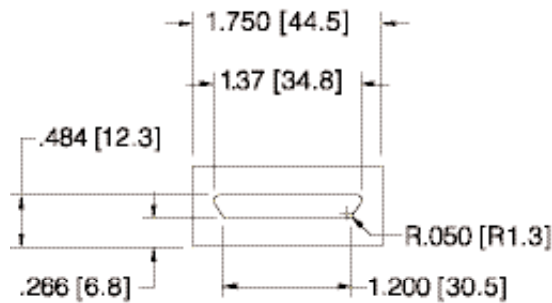

### RJ-11 Connector, Part Number 4164-FH

Usage: Telecom, Ethernet Networking

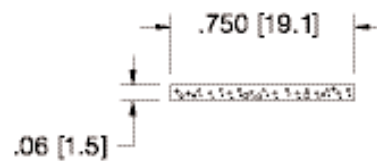
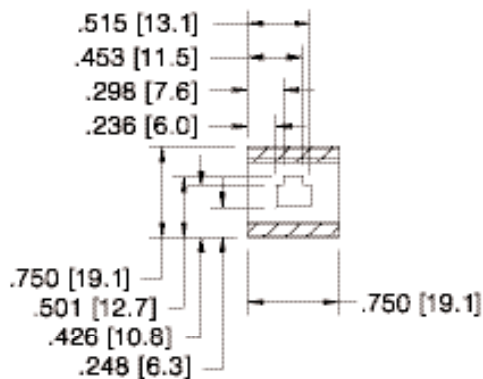



### SCSI + 68 Pin Connector, Part Number 4164-FF

Usage: Peripheral, External Hard Drive

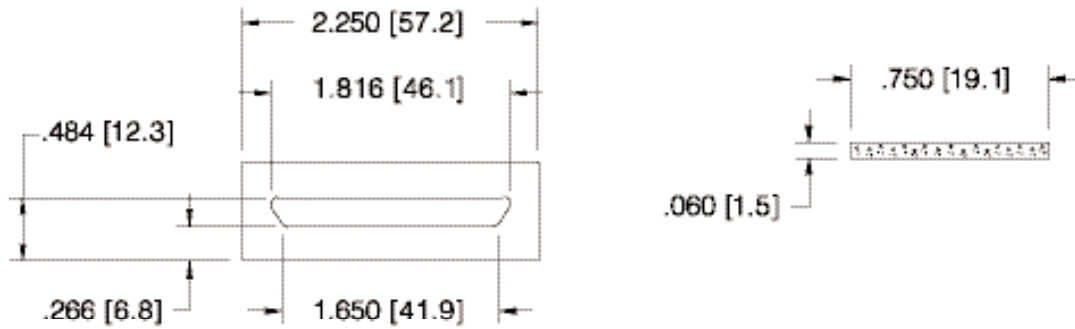

### USB Port Connector, Part Number 4080-FK

Usage: Peripheral Port

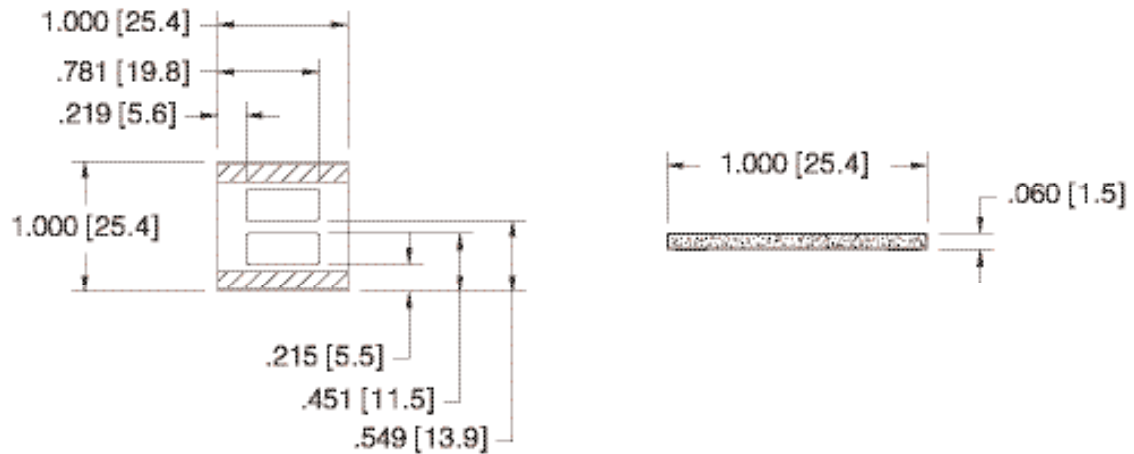



**Part Number Example:**

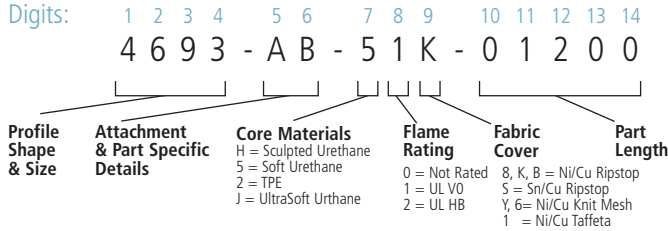

\* Certain combinations of materials may not be available for all Profiles or I/Os. Please consult the Engineering Department at Laird Technologies when unsure. See back cover for contact information.

**Digits 1 through 4**

Designate profile number. Select profile or I/O and sizes from pages 9-13 (Profile) or 15-17 (I/O).

**Digits 5 through 6**

Designate part-specific attributes of the product including cutouts, notches, tape width, tape position and a variety of other customized details. A B is the default and usually designates Pressure Sensitive Adhesive centered on base. These digits will be supplied by Laird Technologies' Engineering personnel.

**Digits 7 through 9**

Designate the core materials, flame rating and fabric cover combinations. Select these options from the recommended list in the table below. Other foam and fabric combinations are available, please consult Laird Technologies' Engineering Department. See page 8 for additional material performance data.

**Digits 10 through 14**

Designate the part length in inches to two decimal places. For the example shown above, the "01200" denotes a 12.00 inch (304.8mm) long gasket).

**Construction Options**

Part Number Suffix Digits (Digits 7,8,9)	Foam Core	Gasket UL94 Flame Rating	Metallized Fabric Type	Benefits	Target Gasket
J1K	Ultra Soft Urethane	UL94 V0	Ni/Cu Ripstop	Flame Retardant, High Shear Resistant, Low Compression Set, Low Compression Force	Profile
51K	Soft Urethane	UL94 V0	Ni/Cu Ripstop	Flame Retardant, High Shear Resistant, Low Compression Set	I/O or Profile
51Y	Soft Urethane	UL94 V0	Ni/Cu Knit Mesh	Flame Retardant, Low Compression Set	I/O
51S	Soft Urethane	UL94 V0	Sn/Cu Ripstop	Flame Retardant, Shear Resistant, Low Compression Set	I/O or Profile
H1K	Sculpted Urethane	UL94 V0	Ni/Cu Ripstop	Flame Retardant, Shear Resistant, Low Compression Set	Complex Shapes (C-Fold, T-Shaped, etc.)
221	TPE	UL94 HB	Ni/Cu Taffeta	Flame Retardant, Wide Variety of Profile Shapes	Profile
50B	Soft Urethane	Not Rated	Ni/Cu Ripstop	Low Cost, Shear Resistant, Low Compression Set	I/O or Profile
501	Soft Urethane	Not Rated	Ni/Cu Taffeta	Low Cost, Low Compression Set	Profile
506	Soft Urethane	Not Rated	Ni/Cu Knit Mesh	Low Cost, Low Compression Set	I/O

To order, contact our Sales Department at 1.800.843.4556



Laird Technologies' new Sculpted Foam UL94 V0 rated Fabric-Over-Foam product line offers unmatched compression set performance while providing a relatively soft Compression Load Deflection (CLD) curve.

Low compression set results promote better shielding performance over the life of the gasket. For extended periods at room temperature or elevated temperatures (days, weeks, months at 77°F and 158°F [25°C and 70° C]), sculpted foam products yield better compression set values compared to competition. In many cases, sculpted foam products perform 50% better.

Lower CLD properties further reduce the potential for distortion while in application. When the gasket is compressed greater than the recommended 50%, compression force is reduced by half. Typical applications include cabinet applications, servers, and networking equipment.

- Achieves UL94 V0 rating, in a bromine-free product offering. Compliant with European RoHS and WEEE Directives.
- Made with high quality abrasion resistant metallized Ripstop Fabric over open cell polyurethane foam.
- No plastic stiffener base required; gives same performance with a reduction in cost. Contact Engineering for deviations.
- Short lead times
- Quick sample turnaround
- Available as standard product in lengths from 1" - 96" (25.4 mm - 2438.4 mm)

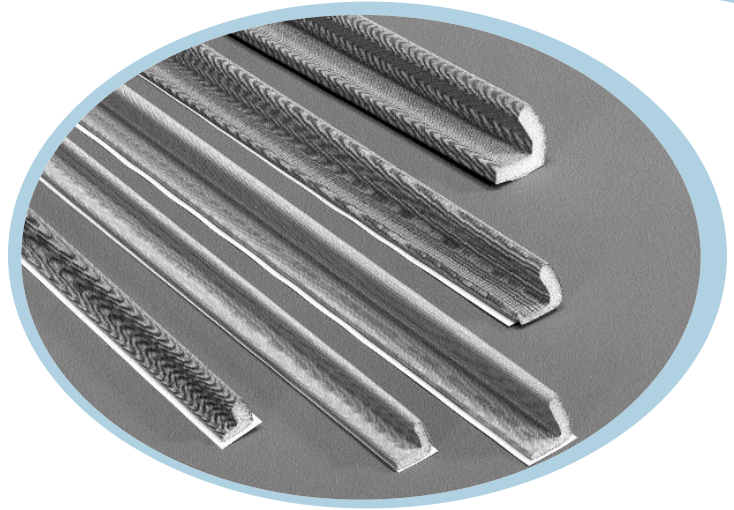

**Modified ASTM 3574 Compression Set Test  
LT 4697-AB-H1K C-Fold vs. Competitive Equivalent**

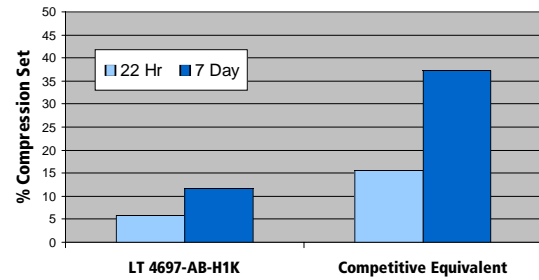

**Shielding Effectiveness Per Mil-Std-285  
Profile 4198**

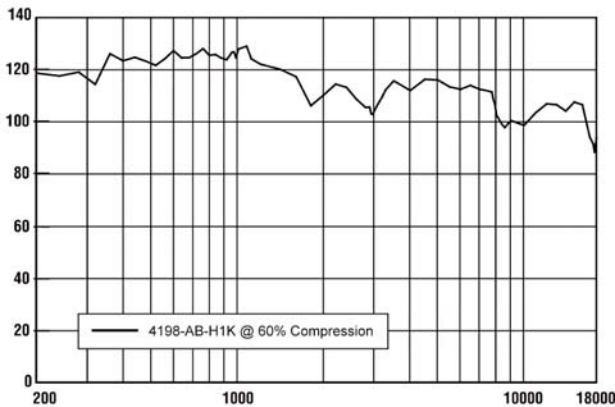

**Force Displacement Resistance Graph of  
LT 4243-AB-H1K vs. Competitive Equivalent**

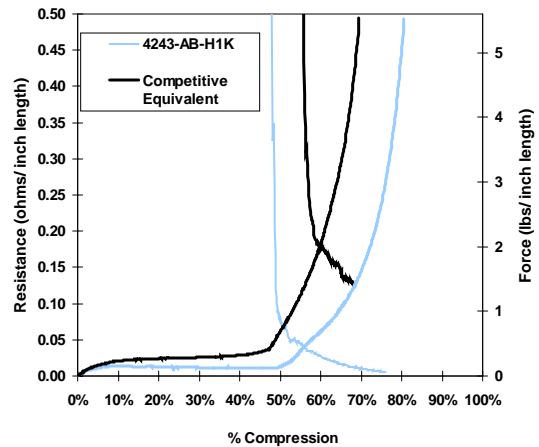

## C-Fold Shape

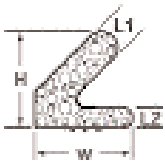

Profile Number	inches (mm) H	inches (mm) W	inches (mm) L1	inches (mm) L2
4593	0.250 (6.4)	0.280 (7.1)	0.125 (3.2)	0.060 (1.5)
4168	0.315 (8.0)	0.315 (8.0)	0.079 (2.0)	0.079 (2.0)
4198	0.385 (9.8)	0.420 (10.7)	0.115 (2.9)	0.060 (1.5)
4243	0.400 (10.2)	0.430 (10.9)	0.125 (3.2)	0.060 (1.0)
4600	0.415 (10.5)	0.450 (11.4)	0.135 (3.4)	0.065 (1.7)
4529	0.465 (11.8)	0.420 (10.7)	0.115 (2.9)	0.060 (1.5)
4697	0.675 (17.1)	0.590 (15.0)	0.165 (4.2)	0.156 (4.0)

\*Other shapes are available. Please contact Laird Technologies Engineering.

## Part Number Information

Example:

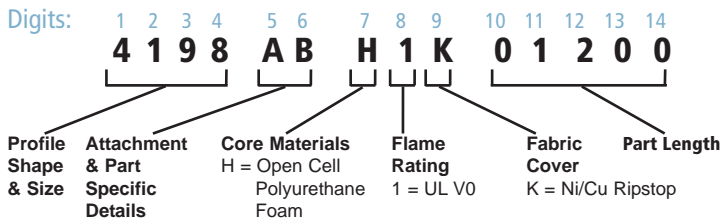

### Digit 1 through 4

Designate profile number. See dimensional chart shown above.

### Digits 5 through 6

Designates part-specific attributes of the product including cutouts, notches, tape width, tape position, and a variety of other customized details. A B is the default and usually designates Pressure Sensitive Adhesive centered on base. These digits will be supplied by Laird Technologies' Engineering personnel.

### Digits 7 through 9

Designates the core materials, flame rating, and fabric cover combinations. Other foam and fabric combinations may be available, please consult Laird Technologies' Engineering Department.

### Digit 10 through 11

Designates the part length in inches to two decimal places. In the above example, the "01200" denotes a 12.00 inch (304.8 mm) long gasket.



Conductive Foam offers an innovative approach to traditional shielding and grounding by providing X, Y, and Z-axis conductivity, which enhances the shielding effectiveness required to meet the increasing microprocessor speeds of today's computer, telecommunications, and aerospace equipment.

Conductive Foam is designed for low-cycling applications such as input/output (I/O) shielding and other non-shear standard connectors. Rectangular strips are available for perimeter gasketing applications.

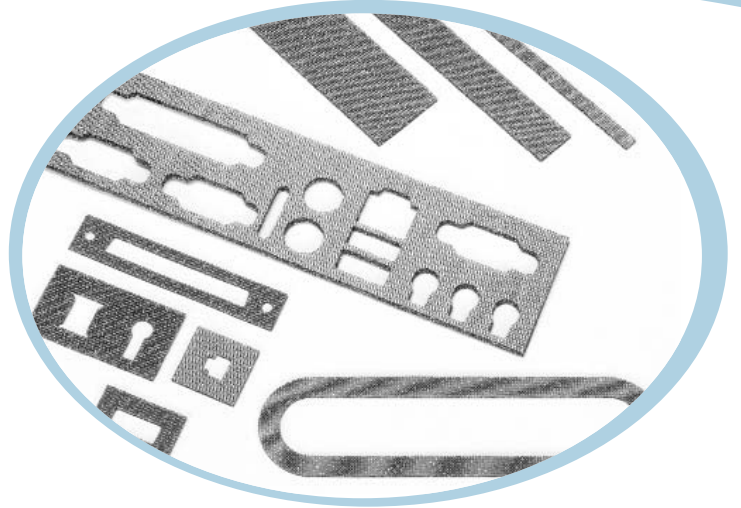

- **Halogen-free** conductive foam gaskets meet 2006 European Union Directives
- Improved Z-axis conductivity increases shielding effectiveness to over 90 dB across a wide range of frequencies.
- Available in 0.039" (1 mm), 0.060" (1.5 mm), 0.079" (2 mm), 0.098 (2.5 mm), 0.125" (3.2 mm), thicknesses and widths down to 0.250" (6.4 mm).
- Wide compression ranges of up to 60% of original uncompressed thicknesses.
- Available in both UL94 HB and V0 rated versions.
- Available in many standard configurations including D-sub, USB port, IEEE 1394, SCSI, and RJ 11 connector. Also available in sheet stock and rectangular profiles.
- Custom die-cut versions are also available.
- Die-cut I/O designs, Rectangle Strip gaskets and Backplane gaskets can be supplied with or without conductive adhesive.
- Conductive Foam has a low compression set ensuring long term gasket performance.
- The recommended operating compression for Conductive Foam EMI gaskets will vary depending on the size of the gasket. Typically gaskets should be compressed 30% - 60% of the original height.

**\*Product Performance / Physical Properties**

X-Y-Axis Surface Resistivity (ASTM F390)	< 0.5 ohms / square
Z-Axis Resistivity (APM 130)	< 0.2 ohms / square inch
Shielding Effectiveness (MIL-DTL-83528C Mod)	> 90 dB (200 MHz to 10 GHz)
Abrasion Resistance (ASTM D3886)	> 1,000,000 Cycles
Service Temperature	-40°F to 158°F (-40°C to 70°C)
Pressure Sensitive Adhesive (ASTM D3330 Mod.)	<i>Conductive:</i> 30 Ounces / Inch Width (Only when PSA is used)

\*Results vary depending on part design. Shielding effectiveness must be verified for specific applications. Contact Engineering for assistance.

**Force Displacement Resistance Graph**  
0.160" (4.0mm) Thick x 1" (25.4mm) Wide  
Ni/Cu Conductive Foam Gasket

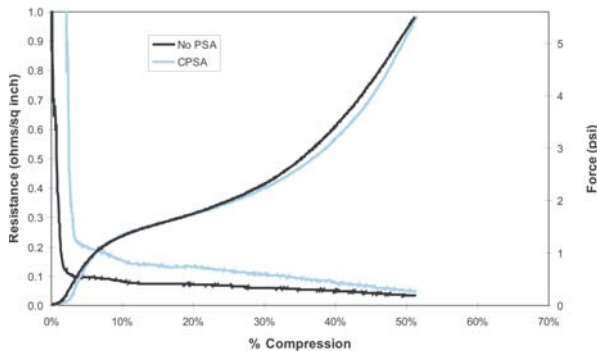

All dimensions shown are in inches (millimeters) unless otherwise specified.

Shielding Effectiveness per MIL-DTL-83528C  
V0 Conductive Foam

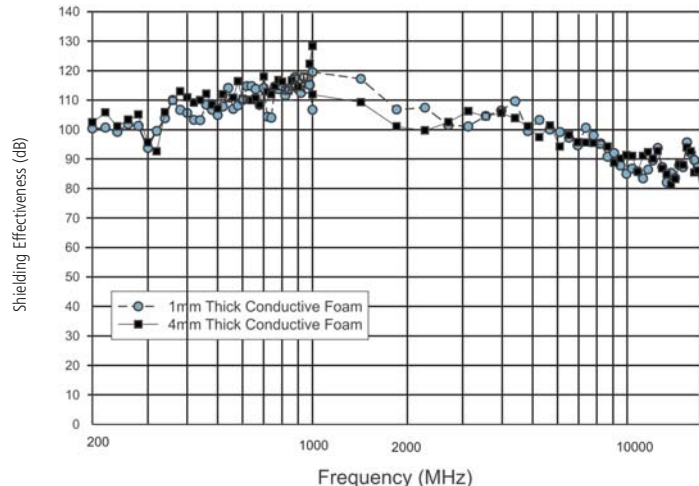

Conductive Foam Gasket Tolerances

Profile	Tolerance Inches (Millimeters)
Height & Width	± .020 (0.5) For Thicknesses ≤ 3.2 mm
<b>Length Inches (Millimeters)</b>	<b>Tolerance Inches (Millimeters)</b>
1 to 6 (25.4 – 152.4)	± .030 (0.8)
6 to 11 (152.4 – 279.4)	± .050 (1.3)
11 to 48 (279.4 – 1219.2)	± .100 (2.5)
48 to 70 (1219.2 – 1778.0)	± .187 (4.7)
70 to 96 (1778.0 – 2438.4)	± .250 (6.4)

For others consult with Engineering.

Pressure Sensitive Adhesive

Pressure Sensitive Adhesive	180° Peel Strength on Stainless Steel	Temperature Resistance	Application	Thickness
Conductive	30 oz/inch width	-40F to 158F (-40C to 70C)	I/O - Backplane Profile Gaskets	2 mils (.051)

Other Pressure Sensitive Adhesives can be provided. Contact Engineering to discuss requirements.

Conductive Foam Construction

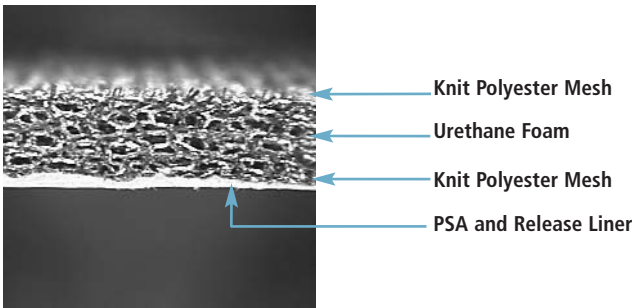

Cross Section  
100% Ni/Cu Metallized

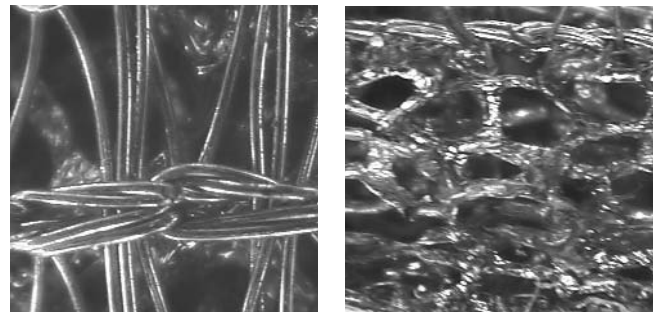

Top and Bottom Surfaces  
Ni/Cu Knit Polyester Mesh

Core  
Ni/Cu Metallized Urethane Foam

Conductive Foam Profile Selection Guide

Conductive Foam in a rectangular profile design provides an excellent alternative to standard Fabric-Over-Foam profile gaskets in low shear applications. Supplied in UL94 HB or UL94 V0 fire rated material, with or without conductive adhesive, Conductive Foam is a cost-effective solution for many perimeter shielding and grounding applications.

Rectangle Shaped

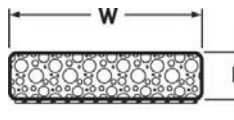

Profile Number	inches (mm) H	inches (mm) W
5286	0.040 (1.0)	1.850 (47.0)
5176	0.040 (1.0)	2.580 (65.5)
5100	0.040 (1.0)	3.346 (85.0)
5997	0.040 (1.0)	4.000 (101.6)
5157	0.060 (1.5)	0.480 (12.2)
5080	0.125 (3.2)	0.500 (12.7)
5023	0.060 (1.5)	1.500 (38.1)
5076	0.060 (1.5)	1.625 (41.3)
5220	0.060 (1.5)	2.205 (56.0)
5214	0.060 (1.5)	2.410 (61.2)
5167	0.060 (1.5)	2.540 (64.5)
5168	0.060 (1.5)	2.660 (67.6)

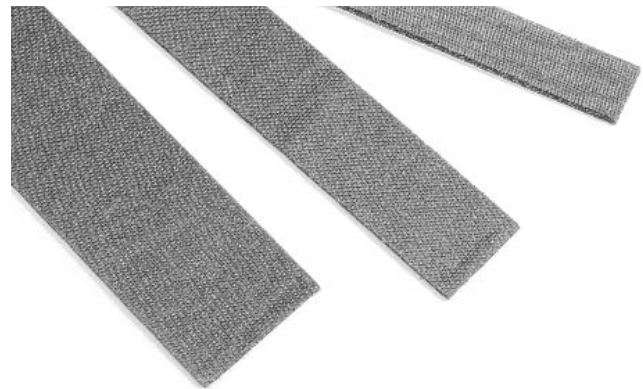

Profile Number	inches (mm) H	inches (mm) W
5078	0.060 (1.5)	2.835 (72.0)
5092	0.060 (1.5)	3.050 (77.8)
5104	0.060 (1.5)	3.400 (86.4)
5174	0.060 (1.5)	3.600 (91.4)
5015	0.060 (1.5)	4.380 (111.2)
5191	0.060 (1.5)	4.000 (101.6)
5125	0.125 (3.2)	0.394 (10.0)
5064	0.125 (3.2)	1.000 (25.4)
5219	0.125 (3.2)	1.500 (38.1)
5169	0.125 (3.2)	2.000 (51.0)
5221	0.125 (3.2)	2.205 (56.0)



For shielding and grounding, conductive foam is an excellent material for Input/Output (I/O) applications. Conductive Foam has excellent X, Y, and Z-axis conductivity and shielding effectiveness over 90 dB for a wide range of frequencies. Laird Technologies can help design custom gaskets to your specifications using a sketch, electronic drawing or your actual equipment.

Shown here are some examples of I/O gaskets designed for specific applications.

### Basic Conductive Foam I/O Gasket Design

- 1 Space between required cutouts and from the edge of the gasket to a cutout should match or exceed the thickness of the part and be greater than 0.060" (1.5 mm). In most cases, a slot can be used in place of a hole.
- 2 All cutouts and locations are designed per customer specifications.
- 3 Pressure-Sensitive Adhesive (PSA) and Extended Release Liner (ERL) can be applied in parallel with the long edge of the gasket.

#### Conductive Foam I/O Gasket Tolerances

Height tolerance:	± .020" (±0.5mm)
Width tolerance:	± .020" (±0.5mm)
Length tolerance:	± .020" (±0.5mm)
Cutout tolerance:	± .020" (±0.5mm)

### D-Sub Connector Series

Part No.	#Pins	A	B	C	D	E	Usage
5164-EE	9	1.320 (33.5)	.984 (25.0)	.650 (16.5)	.155 (3.9)	.310 (8.0)	Serial, Mouse, Com, Port
5164-EA	25	2.204 (56.0)	1.865 (47.4)	1.500 (38.1)	.155 (3.9)	.310 (7.9)	Parallel, Serial, Scanner, Printers
5164-EF	37	2.859 (72.6)	2.535 (64.4)	2.200 (55.9)	.155 (3.9)	.310 (7.9)	Serial Port

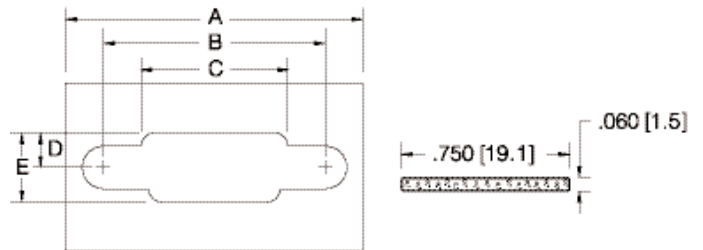

### USB Port 4 Pin Connector, Part Number 5068-EA

Usage: Multi-use, hot plug-and-play

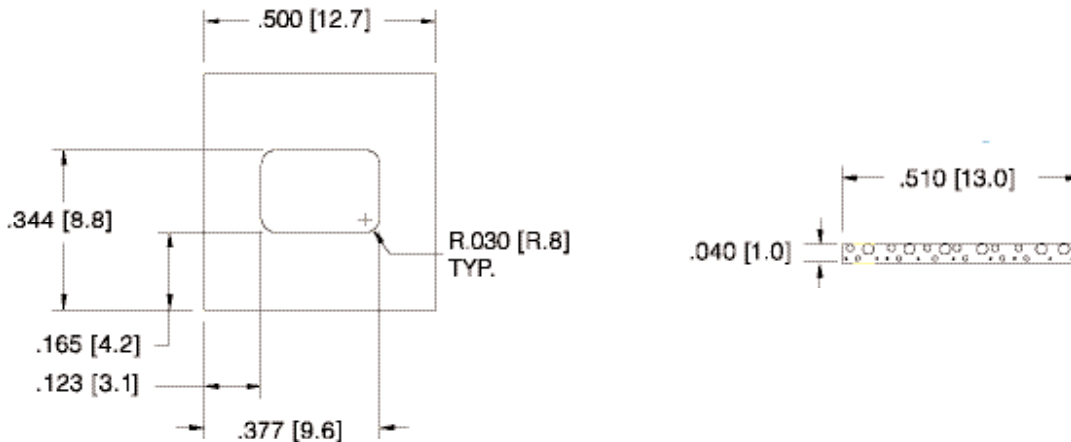



## USB Port Connector, Part Number 5037-EB

Usage: Peripheral Port

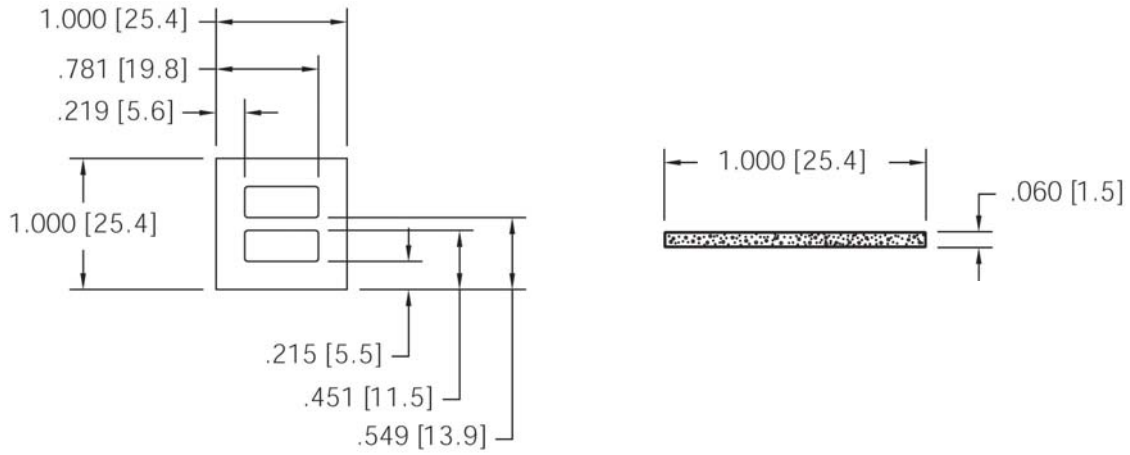

## I/O Connector, Part Number 5239-EG

Usage: Standard PC Motherboard/Main Board (MB) I/O Shield

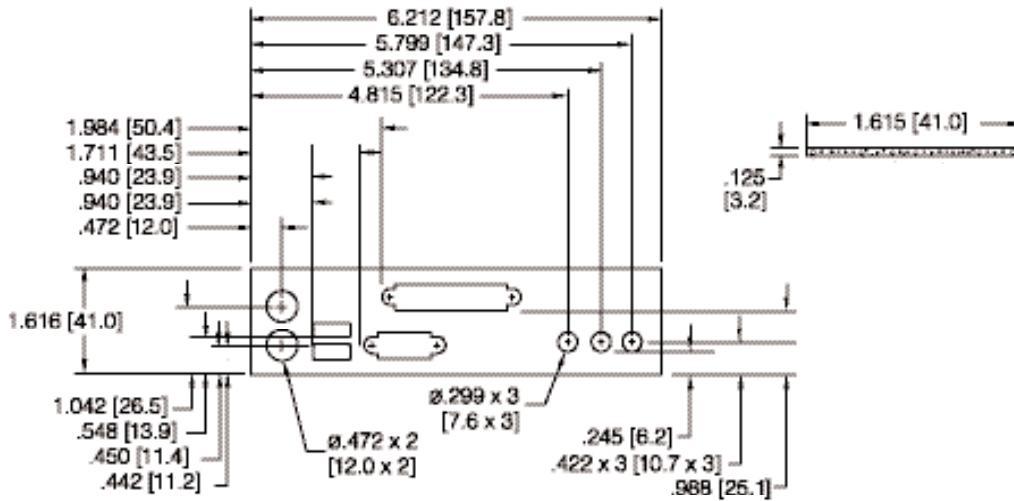



Conductive foam is a perfect material for any size server, router, or switch system. For example, die-cut solutions can be provided at any length by 54" (1370 mm) wide. As with standard I/O gaskets, Laird Technologies can help design a gasket that fits your application.

### Backplane Profile

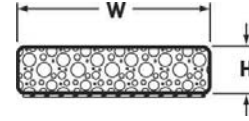

Profile Number	inches (mm) H	inches (mm) W
5010	0.060 (1.5)	6.000 (152.4)
5241	0.060 (1.5)	5.250 (133.4)
5248	0.060 (1.5)	5.630 (143.0)
5269	0.060 (1.5)	5.880 (149.4)
5264	0.060 (1.5)	7.874 (200.0)
5152	0.060 (1.5)	25.500 (647.7)
5044	0.125 (3.2)	6.157 (156.4)
5151	0.125 (3.2)	6.500 (165.1)
5213	0.125 (3.2)	5.819 (147.8)
5249	0.125 (3.2)	6.490 (164.8)
5268	0.125 (3.2)	6.750 (171.5)
5999	0.125 (3.2)	14.000 (355.6)

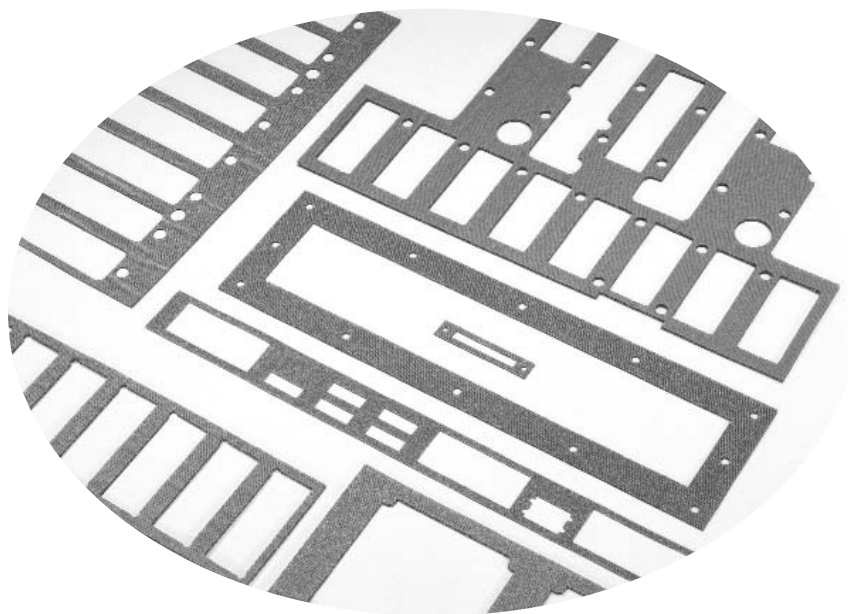

Examples of Large Backplane Gaskets



**Part Number Example:**

Digits:     1 2 3 4     5 6     7 8 9     10 11 12 13 14  
               5 2 3 9 - X X - G 2 W - 0 2 6 0 0

**Digit 1: Product Type**

Designates conductive foam (5).

**Digits 2 through 4: Drawing Number for Basic Profile**

Designate the part shape and size. In the example shown to the left, the "239" indicates a 0.125" (3.2mm) high by 1.615" (41.0mm) wide flat stock gasket. These digits are defined and supplied by Laird Technologies Engineering personnel.

**Digits 5 through 6: General Guidelines of Customized Options**

Designate part-specific attributes of the product including cutouts, notches, tape width, tape position and a variety of other customized details. These digits are also defined and supplied by Laird Technologies Engineering personnel.

**Digit 7: Core Material**

Designates the core material Nickel/Copper (Ni/Cu) foam (G).

**Digit 8: Flammability Rating**

Designates the fire rating:     (1) - UL94 V0  
    (2) - UL94 HB

**Digit 9: Cover Fabric**

Designates the outer covering  
   W = Ni/Cu Mesh with PSA  
   X = Ni/Cu Mesh

**Digits 10 through 14: Specific Cut Lengths**

Designates the part length in inches to two decimal places. In the example above, the "02600" denotes a 26.00 inch (660.40 mm) long gasket.

**Construction Options**

Part Number Suffix (Digits 7,8,9)	Metallized Fabric Type	Core Material	UL94 Fire Rating	General Benefits	Target Application
G1W	Ni/Cu Mesh with PSA	Ni/Cu Foam	UL94 V0	Flame Retardant, Low Compression Set, Adhesive	Profile, I/O, Sheet or Backplane
G2W	Ni/Cu Mesh with PSA	Ni/Cu Foam	UL94 HB	Flame Retardant, Low Compression Set, Adhesive	Profile, I/O, Sheet or Backplane
G1X	Ni/Cu Mesh	Ni/Cu Foam	UL94 V0	Flame Retardant, Low Compression Set	Profile, I/O, Sheet or Backplane
G2X	Ni/Cu Mesh	Ni/Cu Foam	UL94 HB	Flame Retardant, Low Compression Set	Profile, I/O, Sheet or Backplane

To order, contact our Sales Department at 1.800.843.4556



Flectron® metallized fabric combines highly conductive metals with lightweight fabric to meet a diverse range of EMI/RFI shielding requirements. Manufactured with Laird Technologies' patented technology, Flectron metallized fabric is available in various woven and non-woven substrate configurations.

Whether used as an architectural shielding product to shield complete rooms, or as the shielding material in EMI gaskets, tapes, and shield laminates, Flectron fabrics provide a highly effective shielding system that is cost-effective and easily applied.

Laird Technologies uses a patented technology for applying thin metal coatings of copper or nickel to woven and nonwoven fabrics. As a result, Flectron metallized materials have the flexibility, conformability and breathability of a fabric with the electrical properties of a metal. This means low surface and through resistivity and excellent shielding effectiveness.

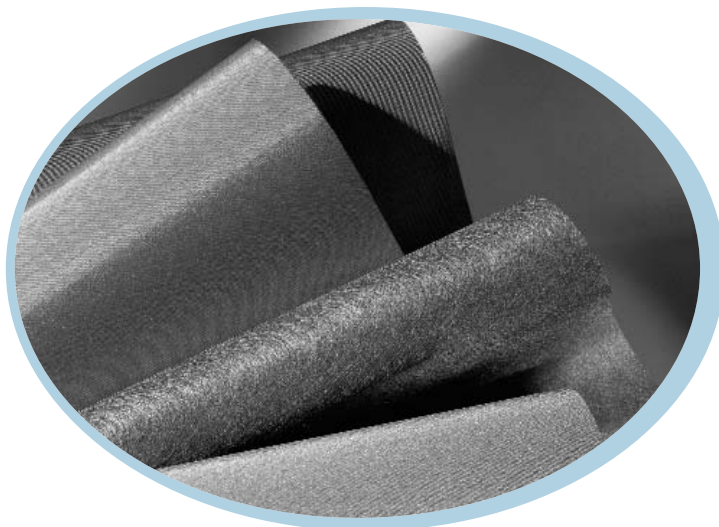

#### Flectron® Products Data Summary

	Product No.	Nominal Thickness Inches (mm)	Surface Resistivity <sup>1</sup> (Ohms / square) (ASTM F390)	Shielding <sup>2</sup> at 100 MHz/1GHz (dB) (Mil-Std 285)	Tensile Strength <sup>3</sup> CD/MD <sup>4</sup> (lb/in) (ASTM D5035)	Air Flow <sup>3</sup> (ft <sup>3</sup> /min/ft <sup>2</sup> )	Weight (oz / yd <sup>2</sup> ) (LT 500)	Max. Short Duration Temperature (°C)
<b>Cu Polyester Nonwoven</b>	3027-106	0.016 (0.4)	≤ 0.1	80/100	7.5/18.5	690	1.5 – 2.3	210
<b>Ni/Cu Polyester Nonwoven</b>	3027-217	0.016 (0.4)	≤ 0.07	105/90	7.5/18.5	690	1.8 – 3.0	210
<b>Ni/Cu Polyester Nonwoven UL94 VTM-0</b>	3027-235	0.016 (0.4)	≤ 0.07	100/100	7.5/18.5	690	13 <sup>†</sup>	210
<b>Ni/Cu Polyester Taffeta</b>	3035-213*	0.006 (0.2)	≤ 0.07	80/80	50/75	66	2.2 – 3.1	210
<b>Ni/Cu Polyester Taffeta UL94 V0</b>	3035-216*	0.008 (0.2)	≤ 0.07	80/70	50/75	NA	8 <sup>†</sup>	100
<b>Ni/Cu Polyester Ripstop</b>	3055-233*	0.007 (0.2)	≤ 0.07	80/70	60/65	68	2.3 – 3.3	210
<b>Ni/Cu Polyester Mesh</b>	3070-500	0.008 (0.2)	≤ 0.1	70/60	64/24	NA	1.3 – 2.3	210
<b>Cu Nylon Ripstop</b>	3050-113	0.005 (0.1)	≤ 0.1	70/70	52/56	97	1.4 – 1.9	200
<b>Ni/Cu Nylon Ripstop</b>	3050-226*	0.005 (0.1)	≤ 0.07	85/75	52/56	97	2.2 – 2.6	200
<b>Ni/Cu Nylon Ripstop UL94 V0</b>	3050-517*	0.008 (0.2)	≤ 0.07	85/75	52/56	NA	5.5 – 7.0	100
<b>Cu Polyester Ripstop</b>	3055-121	0.007 (0.2)	≤ 0.1	90/80	60/65	68	2.0 – 2.7	210

NA = Not Applicable

<sup>1</sup> Product Specifications

<sup>2</sup> Measured per MIL STD 285, Typical values

<sup>3</sup> Typical values for unplated fabric.

<sup>4</sup> CD = cross machine direction, MD = machine direction

<sup>†</sup> Nominal Value

\* Note: Optional anti-fray coating on Ni/Cu woven material.

All dimensions shown are in inches (millimeters) unless otherwise specified.



For specific material properties, see Data Summary Chart (page 27)

Product No.	Material	Description	Application
3027-106	Cu Polyester Nonwoven	Combines a highly conductive metal with the lightweight, flexibility, and breathability of a nonwoven material. Offers excellent surface conductivity, shielding effectiveness, and reflectivity.	Protects against EMI/RFI and ESD where weatherability is not a concern: architectural gaskets, tapes, shielding laminates, and grounding.
3027-217	Ni/Cu Polyester Nonwoven	The base layer is the highly conductive copper, with an outer layer of nickel for corrosion resistance. Combines the properties of these metals with the lightweight, flexibility and breathability of a nonwoven material. Offers excellent surface conductivity, shielding effectiveness, and corrosion resistance.	Protects against EMI/RFI and ESD for a variety of applications and environments: architectural shielding, gaskets, tapes, shielding materials and ribbon.
3027-235	Ni/Cu Polyester Nonwoven UL94 VTM-0	Combines highly conductive copper and corrosion resistant nickel with the lightweight, flexibility and breathability of a nonwoven material. Offers excellent surface conductivity, shielding effectiveness and corrosion resistance. This product achieves the UL94 VTM-0 flammability rating.	Protects against EMI/RFI and ESD for a variety of applications and environments: architectural shielding, gaskets, tapes, shielding laminates, and grounding.
3035-213*	Ni/Cu Polyester Taffeta	Combines highly conductive copper and corrosion resistant nickel with the lightweight, flexibility, conformability, strength and uniform appearance of a woven. Nickel/Copper Polyester Taffeta offers excellent surface conductivity, shielding effectiveness, and reflectivity.	Protects against EMI/RFI for a variety of applications and environments: enclosures, curtains, gaskets, cable wrap, tapes, shielding laminates, and grounding.
3035-216*	Ni/Cu Polyester Taffeta UL94 V0	Combines highly conductive copper and corrosion resistant nickel with the lightweight, flexibility, conformability, strength and uniform appearance of a woven material. Nickel/Copper Polyester Taffeta offers excellent surface conductivity shielding effectiveness, and reflectivity.	Protects against EMI/RFI for a variety of applications and environments: enclosures, curtains, gaskets, cable wrap, tapes, shielding laminates, and grounding.
3055-233*	Ni/Cu Polyester Ripstop	The base layer is the highly conductive copper, with an outer layer of nickel for corrosion resistance. Combines the properties of these metals with the lightweight, drapability, strength, and attractive appearance of a Polyester Ripstop. Nickel/Copper Polyester Ripstop offers excellent surface conductivity, shielding effectiveness, and corrosion resistance.	Protects against EMI/RFI and ESD for a variety of applications and environments: enclosures, cables, gaskets, tapes, and grounding.
3070-500	Ni/Cu Polyester Mesh	Combines highly conductive copper and corrosion resistant nickel with the lightweight, flexibility, conformability, breathability and uniform appearance of a knitted mesh. Mesh offers excellent surface conductivity, shielding effectiveness, and reflectivity for a variety of applications.	Protects against EMI/RFI for a variety of applications and environments: enclosures, curtains, gaskets, cable wrap, tapes, shielding laminates, and grounding.
3050-113	Cu Nylon Ripstop	This technology combines a highly conductive metal with the lightweight, drapability, strength, flexibility, conformability, and attractive appearance of a nylon ripstop. Copper Nylon Ripstop offers excellent surface conductivity, shielding effectiveness, and reflectivity.	Protects against EMI/RFI where weatherability is not a concern: enclosures, curtains, tapes, shielded laminates, infrared camouflage, and radar reflector.
3050-226*	Ni/Cu Nylon Ripstop	This technology combines highly conductive copper and corrosion resistant nickel with the lightweight, drapability, strength, flexibility, conformability, and attractive appearance of a Nylon Ripstop. Nickel/Copper Nylon Ripstop offers excellent surface conductivity, shielding effectiveness, and reflectivity.	Protects against EMI/RFI: enclosures, curtains, gaskets, tapes, shielded laminates, infrared camouflage, and radar reflector.
3050-517*	Ni/Cu Nylon Ripstop UL94 V0	This technology combines highly conductive copper and corrosive resistant nickel with the drapability, strength, flexibility, and attractive appearance of a Nylon Ripstop fabric. Provides excellent surface conductivity, shielding effectiveness, and UL94 V0 rating.	Protects against EMI/RFI: enclosures, cables, tapes, and grounding.
3055-121	Cu Polyester Ripstop	This technology combines a highly conductive metal with the lightweight drapability and attractive appearance of a Polyester Ripstop. Copper Polyester Ripstop offers excellent surface conductivity and shielding effectiveness.	Protects against EMI/RFI and ESD: enclosures, cables, tapes, grounding, infrared camouflage, and radar reflector.

\* Note: Optional anti-fray coating on Ni/Cu woven material.  
All dimensions shown are in inches (millimeters) unless otherwise specified.



### MRI "A" Fabric

Laird Technologies' MRI "A" Fabric is an EMI/RFI shielding product that is manufactured using a patented, proprietary technology. The base layer is a metallized non-woven fabric plated with highly conductive copper and nickel for corrosion resistance. This is bonded to a thin layer of solid aluminum. The resulting material is a lightweight architectural material with superior shielding effectiveness and outstanding resilience. Specifically, this product provides superior shielding effectiveness well in excess of industry standards throughout the MRI frequency range. The product can be applied using several standard construction techniques depending upon the installation requirements or specifications. Because of the relative ease of installation with this product, construction time and therefore, the time to get the MRI facility on-line is greatly reduced.

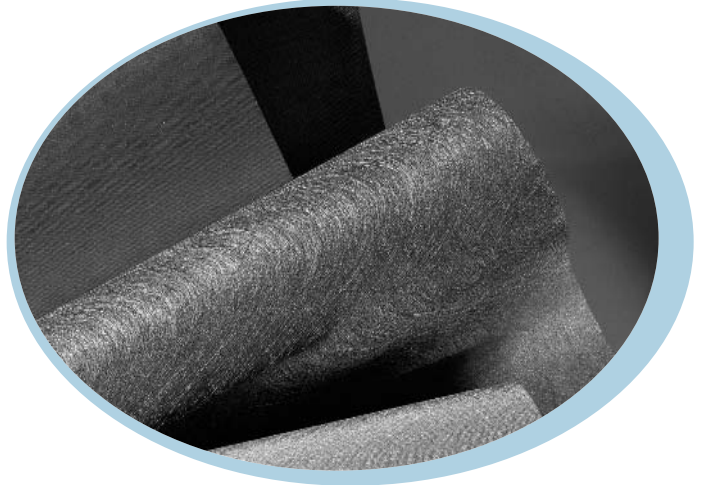

- Flexible and lightweight
- Corrosion resistant and highly conductive
- Provides excellent shielding
- Excellent electrical properties
- Fewer seams required

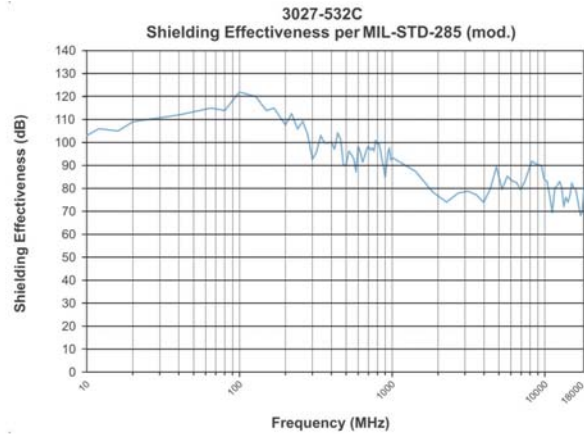

### Physical Properties

Substrate	Metal	Thickness (ASTM D1777)	Total Weight oz./yd <sup>2</sup>	Max. Short Duration Temp. (g/m <sup>2</sup> )	Standard Roll Width inches (cm)
Composite Polyester Non-woven Fabric and Foil	Fabric: Nickel/Copper Foil: Aluminum	0.016 +/- 0.002 (406 +/- 51)	7.5 +/- 1.3 (254 +/- 44)	194°F (90°C)	51 (130)

### Electrical Properties

Surface Resistivity ASTM F390 ohms/square	Shielding Effectiveness dB (typical)				
	25.4 MHz	64 MHz	100 MHz	168 MHz	400 MHz
< 0.07	>108*	>115*	>122*	>115*	>107*

\*Values exceed the dynamic range of the test equipment and were measured in actual MRI shielded enclosures.

### Mechanical Properties

Tensile Strength CMD/MD (ASTM D5035) lb./in (N/100mm)	Elongation, MD (ASTM D5035)
20/60 (350/1050)	8%

All dimensions shown are in inches (millimeters) unless otherwise specified.



### Conductive ElectroMask Tape

ElectroMask conductive foil tape with release mask is a tinned copper tape with peel off mask that allows for high temperature adhesion to withstand curing after painting.

The tape provides a conductive, non-corroding surface when applied to clean metal frames, doors, or panel surfaces where electrical conductivity is required. The release mask is easily removed from the foil layer after painting. The remaining foil leaves a clean, electrically conductive path as a mating surface for an EMI gasket.

- Simple installation.
- Eliminates plating the entire cabinet.
- Die-cut shapes can be provided for grounding points within the closure.

ElectroMask Tape with release mask is offered in continuous rolls of 108 feet (32,92 m), or custom die-cut shapes.

### Application Instructions For Release Mask Tape

1. Conductive surface must be clean and free of any residue. If required, re-new mounting surface with light emery cloth or proper solvent.
2. Apply release mask tape by removing protective paper backing. Press firmly and uniformly to ensure good adhesion. Proper alignment is important. Avoid removal and repositioning. Allow one hour for bonding prior to additional processing.
3. Use traditional methods to apply paint to masked area. Release mask tape will withstand baking temperatures up to 437°F (225°C) up to 60 minutes.
4. Remove mask as soon as the enclosure cools to room temperature by peeling backward, parallel to foil tape. If foil separates from the surface, simply press back in place.
5. Full adhesion is achieved after 24 hours.

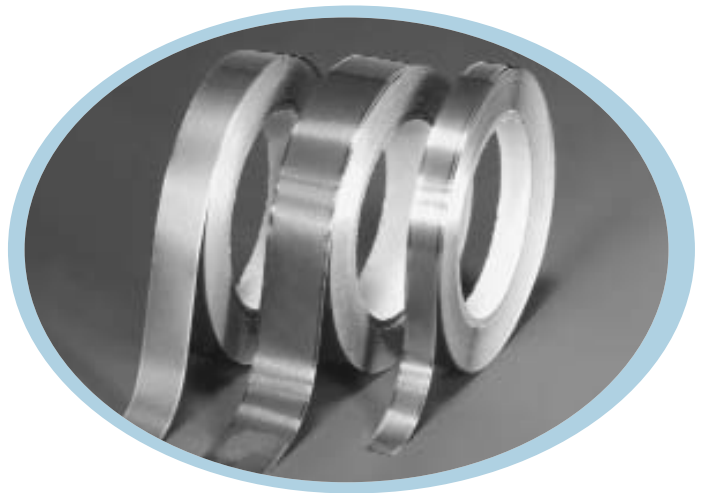

Part No.	Width	Description	Length of Rolls	Peel Adhesion	Temperature Range	Thickness	Shielding Effectiveness dB (Per MIL-STD-285)				
							100 KHz	1 MHz	500 MHz	1 GHz	18 GHz
8274-0050-76	0.50 (12,7)	Tin Plated Copper Foil Tape	108 ft.	35 oz./in.	40 – 437°F	0.0065	>141	137	102	116	87
8274-0075-76	0.75 (19,0)	with Release Mask and	(32,92 m)	(383,09 N/m)	(4.4 – 225°C)	(0,16)					
8274-0100-76	1.00 (25,4)	Conductive Adhesive									

For length and widths not shown, design assistance, samples, or further information, contact our sales department at 1.800.843.4556.



## High-Flex® Conductive Fabric Shielding Tape

High-Flex® conductive fabric shielding tapes offer exceptional conformability and conductivity for dynamic flex applications. High-Flex® tapes are constructed of Flectron® nickel/copper metallized ripstop with a conductive pressure sensitive adhesive (PSA). This reliable tape design provides outstanding shielding performance while offering superior abrasion and corrosion resistance under high dynamic flex conditions.

The proprietary anti-fray coating of High-Flex® EMI shielding tapes virtually eliminates concerns of loose conductive fibers and their potential to cause board level damage. Other significant advantages over other fabric and foil shielding tapes include:

- Thinner design provides superior flexibility and durability.
- High conductivity and shielding effectiveness.
- Adhesive system provides high peel strength.
- Easy die-cutting and processing.
- Superb adhesion of nickel copper plating.
- Eliminates the potential of injury due to the sharp edges of metal foil tapes.

High-Flex® EMI shielding tape is available in standard roll widths from 0.394" (10 mm) to 1.969" (50 mm) in 0.197" (5 mm) increments and roll lengths of 65.62' (20 M). Master rolls are available in sizes up to 1.4 meter widths and 300 meter lengths. For your unique design requirements, custom die-cut parts are also available.

Some typical applications for High-Flex® EMI shielding tapes include:

- Shielding cables on notebook computers, copiers or other electronic equipment.
- "Fix-it" applications in test laboratories.
- Shielding over a component in which high conformability is essential.
- Shielding or grounding in weight sensitive applications.
- Shielding or grounding for electronic equipment where vibration may be present during operation.

### Tape Construction

Carrier	Flectron® Nickel Copper Ripstop Fabric (1A)
Adhesive	Conductive Pressure Sensitive Acrylic Adhesive
Liner	Kraft Paper

### Performance Characteristics

	High-Flex® Tape
	1A = Nickel Copper Ripstop Fabric
Conductive Tape Thickness	0.006 inches (0.15 mm)
Liner Thickness	0.005 to 0.006 inches (0.13 mm to 0.15 mm)
Tensile Strength (ASTM D5035)	50 lb / in.
Weight (LT 500)	2.3 to 3.0 oz./sq. yard (78.0 to 118.7 grams/sq. Meter)
XY Sheet Resistivity (ASTM F390)	Below 0.08 ohms/sq. (Typically 0.03 ohms/sq.)
Peel Strength	48 oz./in. (52 N/100 mm)
Abrasion Resistance (ASTM D3886)	> 1,000,000 Cycles
Temperature Range	-40°F to 212°F (Min/Max) (-40°C to 100°C)
Shielding Effectiveness per Mil-Std-285 (Mod.)	> 70 dB up to 18GHz

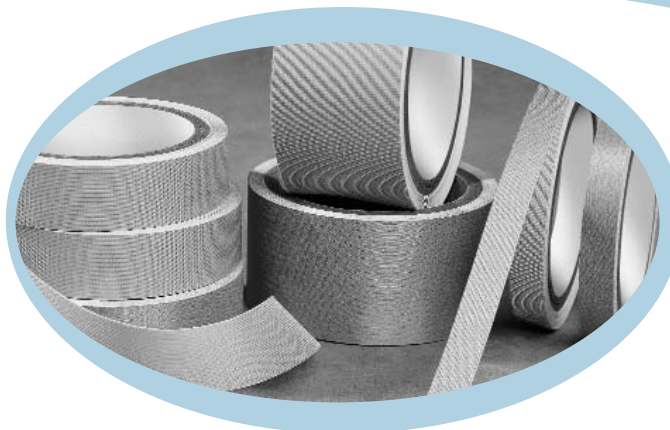

### Ordering Information:

Digits: 1 2 3 4 5 6 7 8 9 10 11  
1 A 0 2 5 0 R 0 2 0 0

#### Digits 1 and 2

Designate conductive tape product line and fabric options: 1A = Nickel Copper Ripstop Fabric

#### Digits 3 through 6

Designate width in millimeters to one decimal place. In the example shown above, the 0250 indicates a 25 mm wide roll).

#### Digit 7

Designates the form the tape is provided in:  
R = Roll K = Kiss-Cut in Pieces P = Pieces

#### Digits 8 through 11

Designate the roll length in meters to one decimal place. The above example 0200 indicates a roll length of 20 meters).

### Shielding Effectiveness

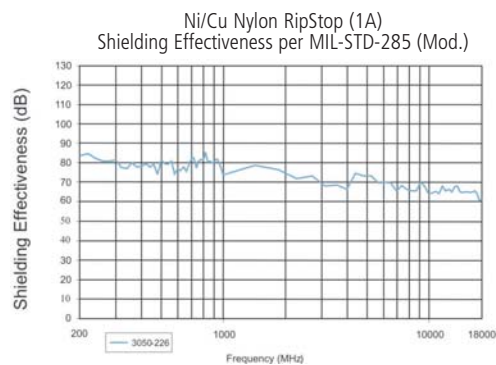







## **NORTH AMERICA**

Our USA toll-free telephone number is  
+1.800.843.4556

### **Delaware Water Gap, USA**

Shielding Way  
P.O. Box 650  
Delaware Water Gap, PA 18327  
Phone +1.570.424.8510  
Fax +1.570.424.6213

### **St. Louis, USA**

3481 Rider Trail South  
St. Louis, MO 63045  
Phone +1.314.344.9300  
Fax +1.314.344.9333

### **San Jose, USA**

2030 Fortune Drive  
Suite 100  
San Jose, CA 95131  
Phone +1.408.544.9500  
Fax +1.408.577.0691

### **San Marcos, USA**

1825 Diamond Street  
San Marcos, CA 92069  
Phone +1.760.736.7007  
Fax +1.760.736.7008

### **Schaumburg, USA**

1751 Wilkening Court  
Schaumburg, IL 60173  
Phone +1.847.839.6000  
Fax +1.847.519.9682

## **EUROPE**

### **Germany**

Äußere Oberaustraße 22  
83026  
Rosenheim, Germany  
Phone +49.8031.24600  
Fax +49.8031.246050

### **Czech Republic**

Prumyslova 497  
462 11 Liberec  
Czech Republic  
Phone +420.48.8575111  
Fax +420.48.8575301

### **France**

13-15 rue des Entrepreneurs  
91560 Crosne, France  
Phone +33.1.69497979  
Fax +33.1.69497980

### **United Kingdom**

Warner Drive  
Springwood Industrial Estate  
Braintree  
Essex CM7 2YW  
Phone +44.1376.342626  
Fax +44.1376.346442

## **ASIA**

### **Taiwan**

4F, No. 6  
Hou-Sheng Road  
Luchu, Taoyuan, Taiwan 338  
Phone +886.33.129292  
Fax +886.33.129090

### **Tokyo, Japan**

Shin Yokohama Business Center Building 7F  
2-6, Shin Yokohama 3-chome, Kohoku-ku  
Yokohama-shi, Kanagawa 222-0033, Japan  
Phone +81.45.4736808  
Fax +81.45.4736162

### **Yokohama, Japan**

2-12-8 Sachiura, Kanazawa-ku  
Yokohama-shi, 236-0003, Japan  
Phone +81.45.7851063  
Fax +81.45.7851064

### **Shanghai, China**

Building 1, Number 58  
Hua Ning Road, Lane 4018  
Shanghai, P.R. China 201108  
Phone +86.21.6442.8018  
Fax +86.21.6489.6055

### **Shenzhen, China**

No. 2 Building, 2nd Industry Park  
Tangxiayong Songgang Town  
Baoan District, Shenzhen City  
Guangdong Province  
China 518105  
Phone +86.755.2714.1166  
Fax +86.755.2714.1199

### **Suzhou, China**

No. 228 Tongyuan Road  
Suzhou Industry Park  
Suzhou, P.R.China 215006  
Phone +86.512.6252.6590  
Fax +86.512.6252.7226

### **Tianjin, China**

Building B, Fenghua Industrial Park  
66 on the Ninth Avenue, TEDA  
Tianjin, P.R. China 300457  
Phone +86.22.6629.8160  
Fax +86.22.6629.8158

### **Singapore**

750E Chai Chee Road #03-07/08  
Technopark@Chai Chee  
Singapore 469005  
Phone +65.624.38022  
Fax +65.624.38021

### **Korea**

2nd Floor, Hwasung Building  
34-2 Chunho-dong  
Kangdong-ku, Seoul, Korea  
Phone +82.2.4771390  
Fax +82.2.4771393

NOTICE: Although the information and recommendations set forth herein (hereinafter "information") are presented in good faith and believed to be correct as of the date hereof, Laird Technologies makes no representation or warranties as to the completeness or accuracy thereof. Information is supplied upon the condition that the persons receiving same will make their own determination as to its suitability for their purposes prior to use. In no event will Laird Technologies be responsible for damages of any nature whatsoever resulting from the use or reliance upon information or the product to which information refers. Nothing contained herein is to be construed as a recommendation to use any product, process, equipment or formulation in conflict with any patent, and Laird Technologies makes no representation or warranty, expressed or implied, that the use thereof will not infringe any patent. The data set forth in all tables, charts, graphs and figures herein are based on samples tested and are not guaranteed for all samples or applications. Such data are intended as guides and do not reflect product specifications for any particular product. NO REPRESENTATION OR WARRANTIES, EITHER EXPRESSED OR IMPLIED, OR MERCHANTABILITY, FITNESS FOR A PARTICULAR PURPOSE OR OF ANY OTHER NATURE ARE MADE HEREUNDER WITH RESPECT TO INFORMATION OR THE PRODUCT TO WHICH INFORMATION REFERS.

Ultrasoft®, Sticky Fingers®, Magnefil®, ElectroNit®, Contips®, Snap-Tite® and Grip-Tite® are registered trademarks of Laird Technologies.  
Poron® is a registered trademark of Rogers Corporation.

**global solutions :**  
**local support™**