

FEATURES

- RoHS compliant
- Maxim MAX253 compatible
- 3.3V and 5V versions
- Isolation to 4kV_{DC}
- Frequency range to 500kHz
- Toroidal construction
- Industry-standard pinout
- UL 94 V-0 package materials
- Fully encapsulated
- Low profile
- Surface mount option
- Industrial temperature range

DESCRIPTION

The 78253 series of converter transformers are specifically designed for use with the MAX253 chip set to provide isolated power supplies. The 5V version can supply 1W and the 3.3V version can supply 500mW. A centre tapped secondary winding allows for full bridge, half bridge or voltage doubling.

SELECTION GUIDE

| Order Code | Input Voltage | Output Voltage | Max. Output Current | Isolation Voltage | Turns Ratio | Package Style |
|-------------|---------------|----------------|---------------------|-------------------|-------------|---------------|
| | V | V | mA | V _{DC} | | |
| 78253/35C | 3.3 | 5.0 | 100 | 1500 | 1:2.27 | DIL |
| 78253/35MC | | | | | | SM |
| 78253/55C | 5.0 | 5.0 | 200 | 1500 | 1:1.31 | DIL |
| 78253/55MC | | | | | | SM |
| 78253/35VC | 3.3 | 5.0 | 100 | 4000 | 1:2.14 | DIL |
| 78253/35MVC | | | | | | SM |
| 78253/55VC | 5.0 | 5.0 | 200 | 4000 | 1:1.33 | DIL |
| 78253/55MVC | | | | | | SM |

78253/35(M)C CHARACTERISTICS

| Parameter | Conditions | Min. | Typ. | Max. | Units |
|---|---------------|------|------|------|-------|
| Primary Inductance, L _p | 100kHz, 250mV | 0.30 | 0.38 | 0.46 | mH |
| Secondary Inductance, L _s | 100kHz, 250mV | 1.60 | 2.00 | 2.40 | mH |
| Leakage Inductance, L _l | 100kHz, 250mV | | 0.30 | 1.00 | μH |
| Interwinding Capacitance, C _{ww} | 100kHz, 250mV | | 30 | 50 | pF |
| D.C. Resistance, R _{DC} | >0.1VDC | | 0.40 | 1.00 | Ω |
| Volt-time Product, Et | 5kHz, 5V | 30 | 35 | | Vμs |

78253/55(M)C CHARACTERISTICS

| Parameter | Conditions | Min. | Typ. | Max. | Units |
|---|---------------|------|------|------|-------|
| Primary Inductance, L _p | 100kHz, 250mV | 0.60 | 0.83 | 1.10 | mH |
| Secondary Inductance, L _s | 100kHz, 250mV | 1.10 | 1.40 | 1.70 | mH |
| Leakage Inductance, L _l | 100kHz, 250mV | | 0.35 | 1.00 | μH |
| Interwinding Capacitance, C _{ww} | 100kHz, 250mV | | 30 | 50 | pF |
| D.C. Resistance, R _{DC} | >0.1VDC | | 0.70 | 1.50 | Ω |
| Volt-time Product, Et | 5kHz, 5V | 40 | 50 | | Vμs |

78253/35(M)VC CHARACTERISTICS

| Parameter | Conditions | Min. | Typ. | Max. | Units |
|---|---------------|------|------|------|-------|
| Primary Inductance, L _p | 100kHz, 20mV | 110 | 142 | 185 | μH |
| Secondary Inductance, L _s | 100kHz, 20mV | 550 | 710 | 850 | μH |
| Leakage Inductance, L _l | 100kHz, 250mV | | 3.00 | 5.00 | μH |
| Interwinding Capacitance, C _{ww} | 100kHz, 250mV | | 4.20 | 8.00 | pF |
| D.C. Resistance, R _{DC} | >0.1VDC | | 0.30 | 0.50 | Ω |
| Volt-time Product, Et | 5kHz, 5V | 18 | 22 | | Vμs |

78253/55(M)VC CHARACTERISTICS

| Parameter | Conditions | Min. | Typ. | Max. | Units |
|---|---------------|------|------|------|-------|
| Primary Inductance, L _p | 100kHz, 20mV | 190 | 240 | 310 | μH |
| Secondary Inductance, L _s | 100kHz, 20mV | 350 | 444 | 540 | μH |
| Leakage Inductance, L _l | 100kHz, 250mV | | 5.20 | 8.00 | μH |
| Interwinding Capacitance, C _{ww} | 100kHz, 250mV | | 4.20 | 8.00 | pF |
| D.C. Resistance, R _{DC} | >0.1VDC | | 0.40 | 0.60 | Ω |
| Volt-time Product, Et | 5kHz, 5V | 25 | 28 | | Vμs |

All specifications typical at T_A=25°C



| ABSOLUTE MAXIMUM RATINGS | |
|---|----------------|
| Operating free air temperature range | -40°C to 85°C |
| Storage temperature range | -50°C to 125°C |
| Lead Temperature 1.5mm from case for 10 seconds | 300°C |
| Peak current I_{PK} | 400mA |
| Isolation voltage 78253/XX(M)C (flash tested for 1 second) | 1500Vdc |
| Isolation voltage 78253/XX(M)VC (flash tested for 1 second) | 4000Vdc |

PACKAGE SPECIFICATIONS

MECHANICAL DIMENSIONS

6 Pin DIL

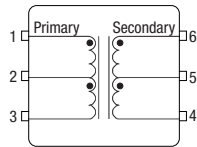
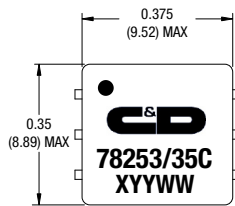

6 Pin SM

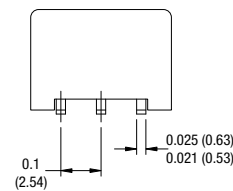
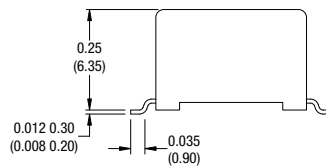
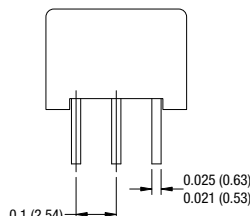
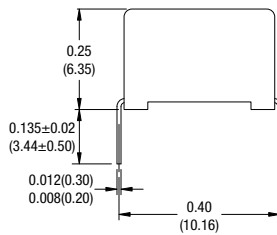
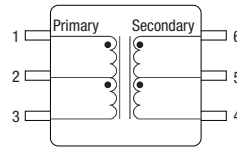
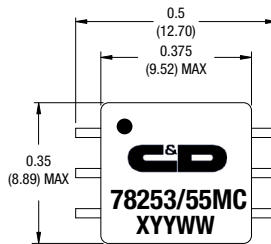

Unless otherwise stated all dimensions in inches (mm) ± 0.01 (0.25).
All pins on a 0.1 (2.54) pitch and within ± 0.01 (0.25) of true position.
Package weight 1.0g Typ.

RECOMMENDED FOOTPRINT DETAILS

6 Pin DIL

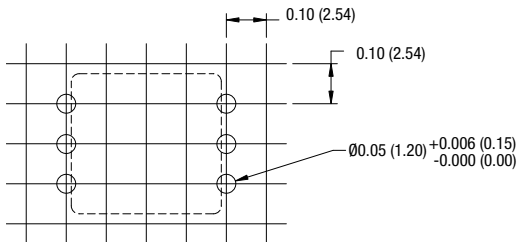

6 Pin SM

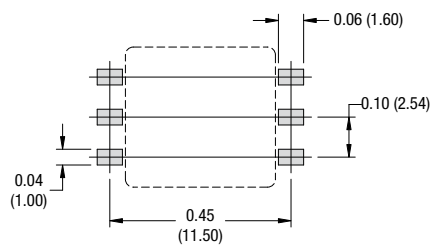

Unless otherwise stated all dimensions in inches (mm) ± 0.01 (0.25).
All pins on a 0.1 (2.54) pitch and within ± 0.01 (0.25) of true position.

TYPICAL CHARACTERISTICS (VOLTAGE CURVES)

VOLTAGE CURVES

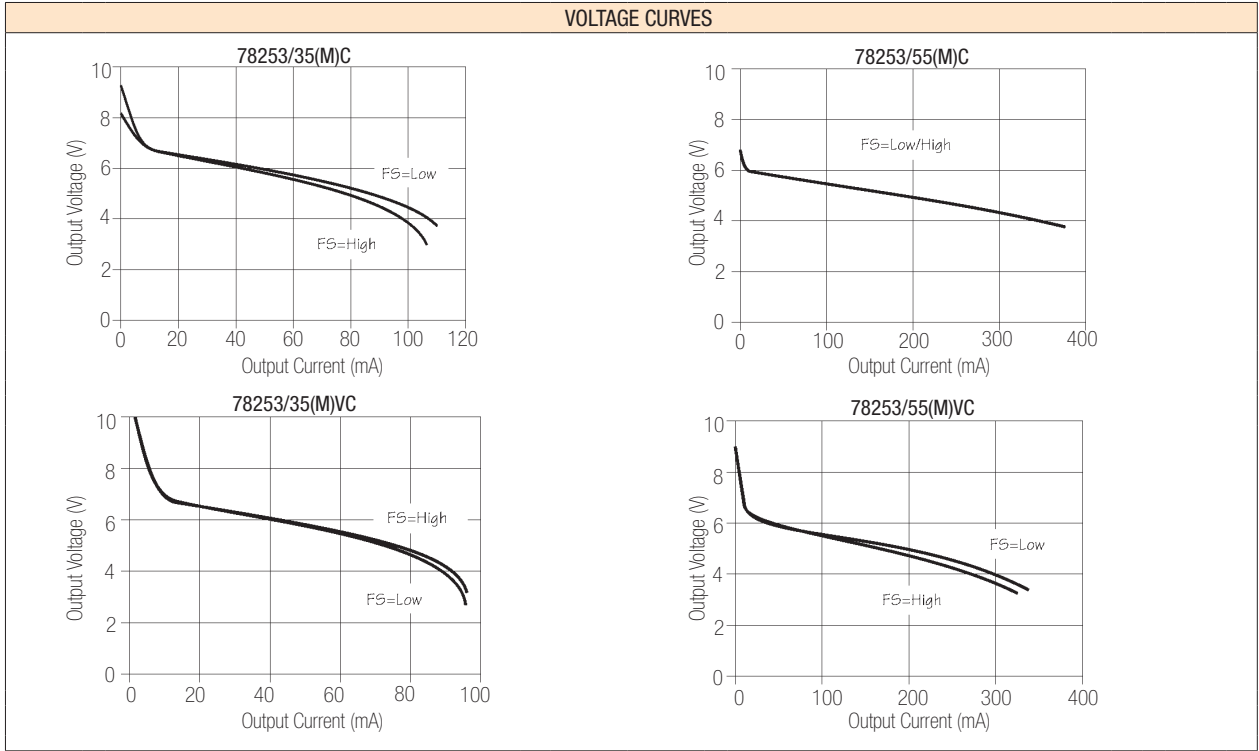

EFFICIENCY CURVES

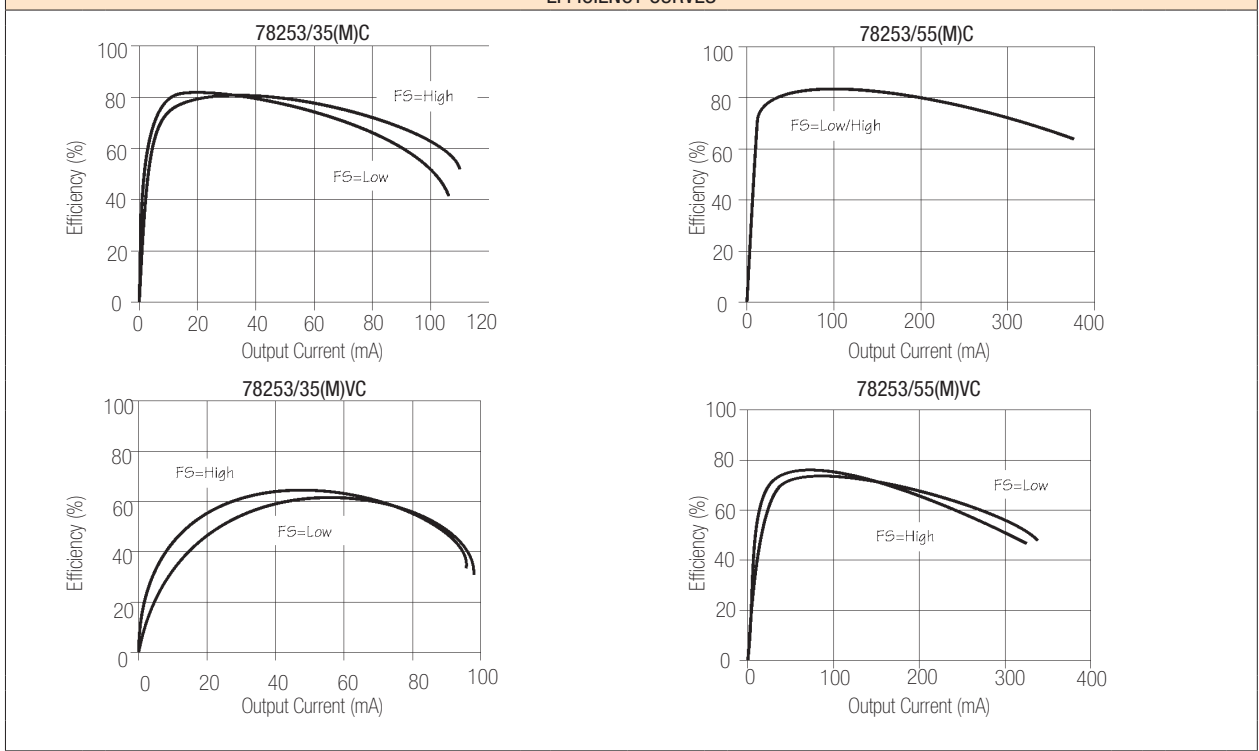

All curves are derived from testing with the Maxim MAX235 IC using the circuit shown in application note MPAN-03 (download at <http://www.cd4power.com/data/apnotes/mpan-03.pdf>).

TYPICAL CHARACTERISTICS (VOLTAGE CURVES) continued

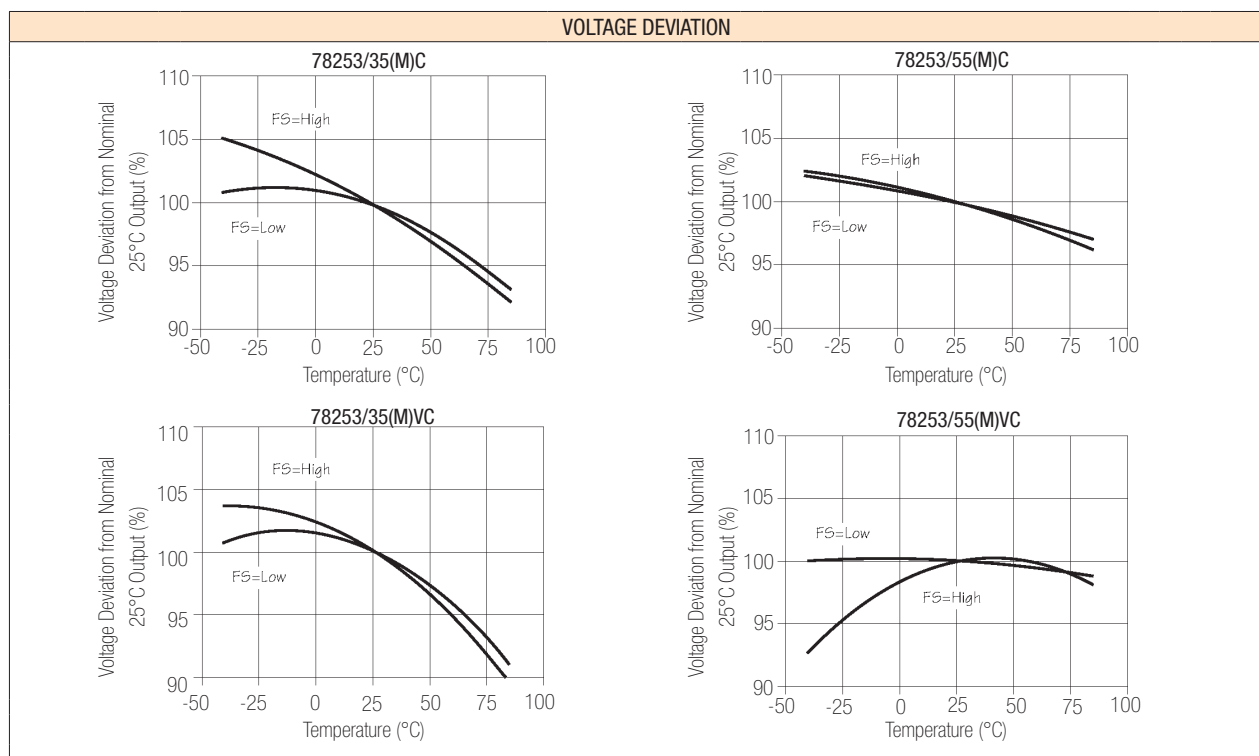

RoHS COMPLIANCE INFORMATION



For through-hole products a peak wave solder temperature of 300°C for 10 seconds is permitted. The pin termination finish on this product series is bright tin. All types are backward compatible with Sn/Pb soldering systems.

For further information, please visit www.cd4power.com/rohs

TUBE OUTLINE DIMENSIONS

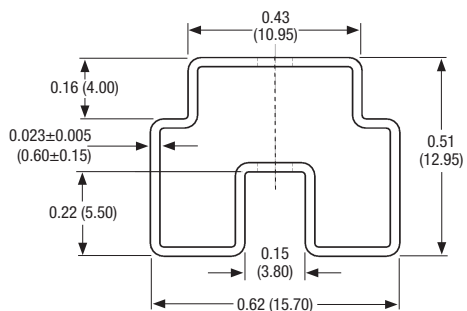

Tube length: 18.3±0.08 (465±2). Tube quantity: 50.

Tube material: Antistatic coated clear pvc.

Unless otherwise stated all dimensions in inches(mm) ±0.01 (0.25).

TECHNICAL NOTES

ISOLATION VOLTAGE

'Hi Pot Test', 'Flash Tested', 'Withstand Voltage', 'Proof Voltage', 'Dielectric Withstand Voltage' & 'Isolation Test Voltage' are all terms that relate to the same thing, a test voltage, applied for a specified time, across a component designed to provide electrical isolation, to verify the integrity of that isolation.

All products in this series are 100% production tested at their stated isolation voltage.

A question commonly asked is, "What is the continuous voltage that can be applied across the part in normal operation?"

For a part holding no specific agency approvals both input and output should normally be maintained within SELV limits i.e. less than 42.4V peak, or 60VDC. The isolation test voltage represents a measure of immunity to transient voltages and the part should never be used as an element of a safety isolation system. The part could be expected to function correctly with several hundred volts offset applied continuously across the isolation barrier; but then the circuitry on both sides of the barrier must be regarded as operating at an unsafe voltage and further isolation/insulation systems must form a barrier between these circuits and any user-accessible circuitry according to safety standard requirements.

REPEATED HIGH-VOLTAGE ISOLATION TESTING

It is well known that repeated high-voltage isolation testing of a barrier component can actually degrade isolation capability, to a lesser or greater degree depending on materials, construction and environment. This series has toroidal isolation transformers, with no additional insulation between primary and secondary windings of enameled wire. While parts can be expected to withstand several times the stated test voltage, the isolation capability does depend on the wire insulation. Any material, including this enamel (typically polyurethane) is susceptible to eventual chemical degradation when subject to very high applied voltages thus implying that the number of tests should be strictly limited. We therefore strongly advise against repeated high voltage isolation testing, but if it is absolutely required, that the voltage be reduced by 20% from specified test voltage.

This consideration equally applies to agency recognized parts rated for better than functional isolation where the wire enamel insulation is always supplemented by a further insulation system of physical spacing or barriers.

TAPE & REEL SPECIFICATIONS

REEL OUTLINE DIMENSIONS

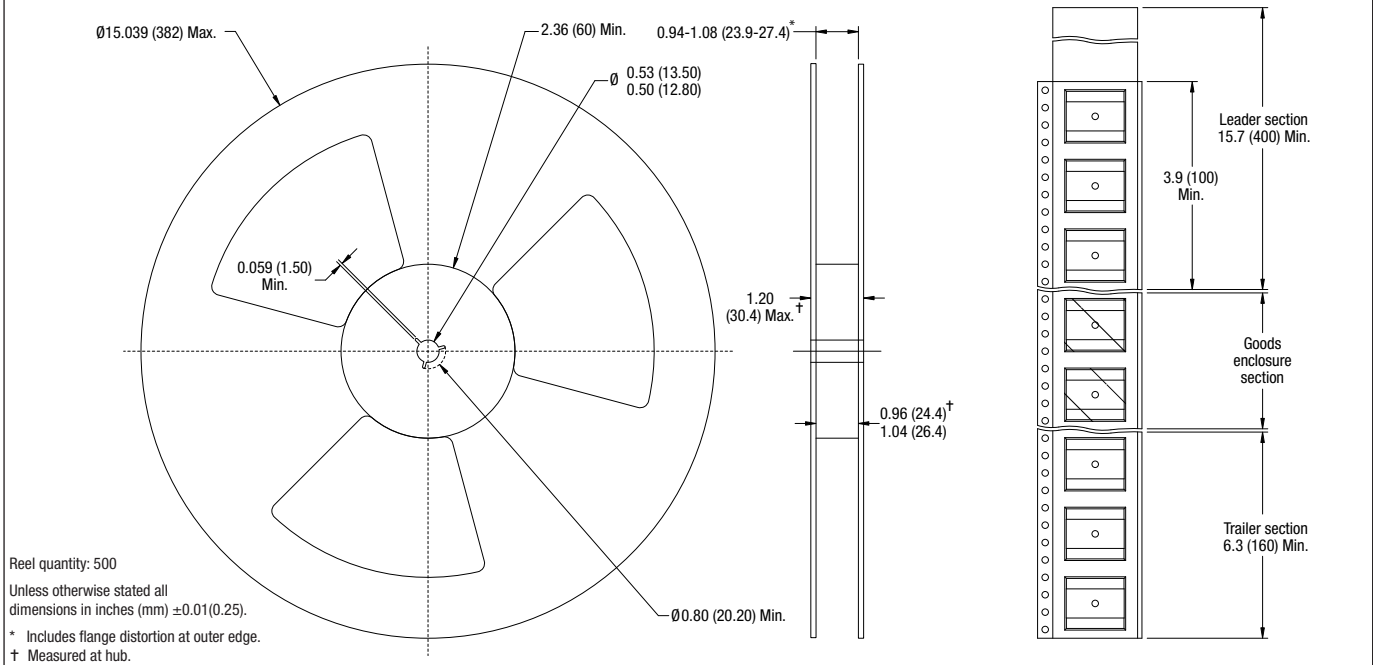

TAPE OUTLINE DIMENSIONS

