

# TP series

## Tiny washable momentary pushbutton switches

*Distinctive features and specifications*



### Sealed

- Single piece case
- O-ring seal between actuator and bushing
- Epoxy sealed terminals

### Wide variety of contact materials

### Same PCB layout as TL, TR and TG tiny switches

#### ELECTRICAL SPECIFICATIONS

- Max. current/voltage rating with resistive load :
  - gold plated contacts : 0,4VA 20V max. AC or DC
  - silver plated contacts : 0,5A 48V max. AC or DC
- Minimum load : 10mA 50mV - 10 $\mu$ A 5VDC
- Contact resistance : 50 m $\Omega$  max.
- Insulation resistance : 1.000 M $\Omega$  min. at 500VDC
- Dielectric strength :
  - 1.000 Vrms 50 Hz min. between terminals and frame
  - 500 Vrms 50 Hz min. between terminals
- Electrical life at full load :
  - gold plated contacts : 60.000 cycles
  - silver plated contacts : 20.000 cycles

#### GENERAL SPECIFICATIONS

- Total travel :
  - function 2 : 1 mm (.039)
  - function 3 : 0,8 mm (.031)
- Strength of terminals : pull-out force - 10N max.
- Operating temperature : -30°C to +85°C
- Moisture : 21 days 95 % (NFC 20-603 - IEC 68-2-3)
- Cleaning : solvents or water + detergent
- Wave soldering : 260°C - 5 sec.

#### MATERIALS

- Case : PBT
- Actuator : polyamide, glass filled
- Contacts and terminals :
  - 0 : brass, gold plated
  - 1 : brass, silver plated
  - 3 : brass, gold plated (1,27 micron gold)
  - 8 : contact brass, gold plated + tin plated terminals
  - 9 : contact brass, gold plated (1,27 micron gold) + tin plated terminals
- Terminal seal : epoxy

B

# TP series

## Tiny washable momentary pushbutton switches

Overview

MODEL  
STRUCTURE

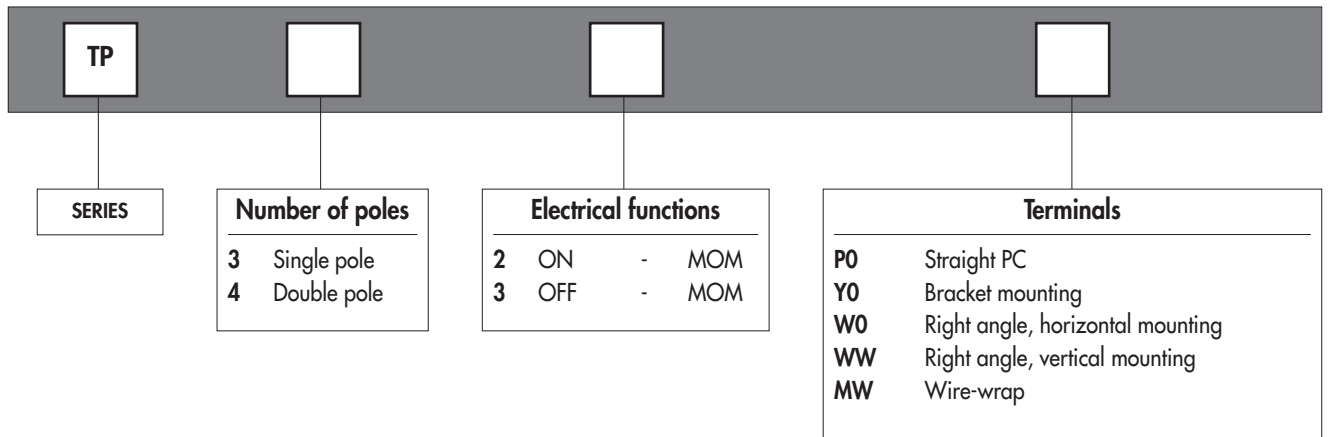

OPTIONS

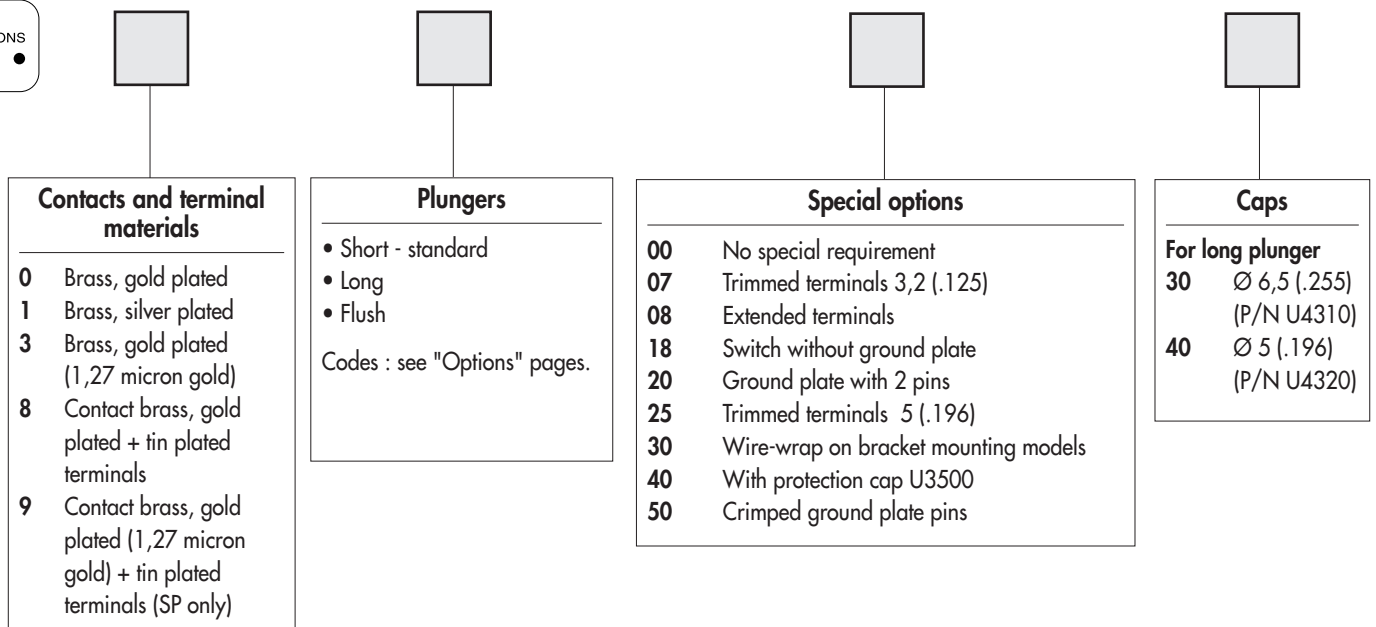

### ABOUT THIS SERIES

On the following pages, you will find successively :

- model structure of switches
- options in the same order as in above chart

**Dimensions** : first dimensions are in mm while inches are shown as bracketted numbers.



**NOTICE** : please note that not all combinations of above numbers are available. Refer to the following pages for further information.



**Packaging unit** : 100 pieces, except for models with WW terminals (50 pieces).



# TP series

## Tiny washable momentary pushbutton switches

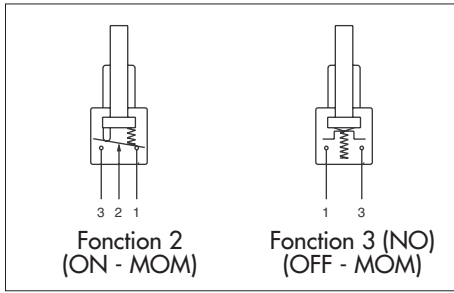

- Straight PC, right angle or wire-wrap terminals
- 1 and 2 pole configurations

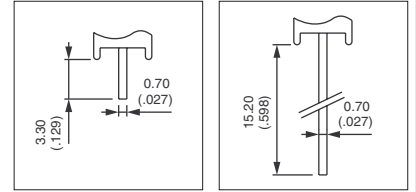

### MODEL STRUCTURE

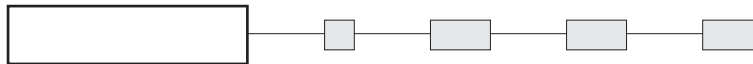

Shown in function 2, with standard plunger

### Straight PC terminals : TP..P0



Single pole	Double pole	ON	MOM
TP32P0	TP42P0	ON	MOM
TP33P0	TP43P0	OFF	MOM

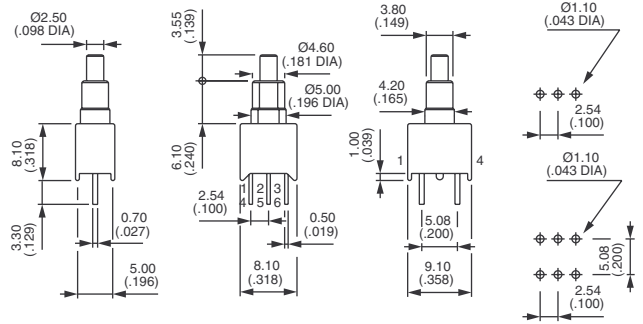

Function 3 has two terminals only (3 and 1) per pole

### Straight terminals - bracket mounting : TP..Y0



Single pole	Double pole	ON	MOM
TP32Y0	TP42Y0	ON	MOM
TP33Y0	TP43Y0	OFF	MOM

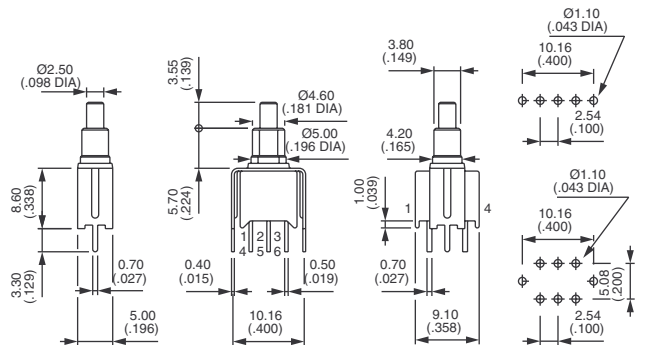

Function 3 has two terminals only (3 and 1) per pole

### Right angle terminals - horizontal mounting : TP..W0



Single pole	Double pole	ON	MOM
TP32W0	TP42W0	ON	MOM
TP33W0	TP43W0	OFF	MOM

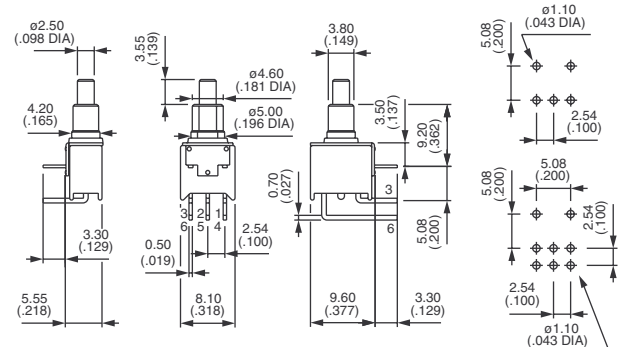

Function 3 has two terminals only (3 and 1) per pole

# TP series

Tiny washable momentary pushbutton switches

MODEL  
STRUCTURE

Shown in function 2, with standard plunger

## Right angle terminals - vertical mounting : TP..WW



Single pole	Double pole		
TP32WW	TP42WW	ON	MOM
TP33WW	TP43WW	OFF	MOM

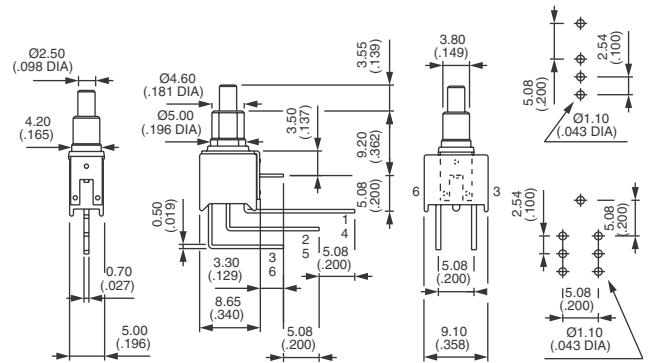

Function 3 has two terminals only (3 and 1) per pole

## Wire-wrap terminals : TP..MW



Single pole	Double pole		
TP32MW	TP42MW	ON	MOM
TP33MW	TP43MW	OFF	MOM

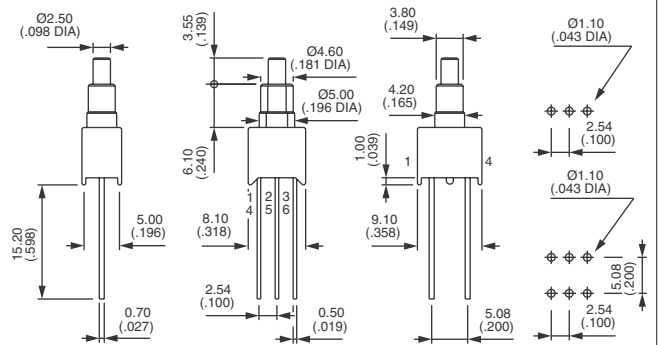

Function 3 has two terminals only (3 and 1) per pole

## PCB MOUNTING

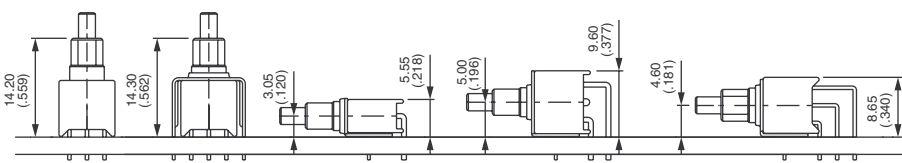

## CAP FOR PCB PROCESSING

Provide additional protection during PCB processing.  
Supplied separately. For cap mounted on the switch, see special option 40.  
Material : vinyl

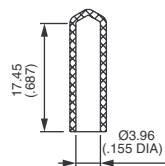

U3502

B



# TP series

## Tiny washable momentary pushbutton switches

### CONTACT AND TERMINAL MATERIALS

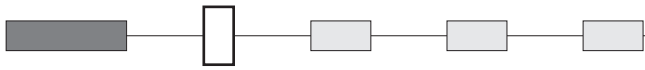

- 0 Brass, gold plated
- 1 Brass, silver plated
- 3 Brass, gold plated (1,27 micron gold)
- 8 Contact brass, gold plated + tin plated terminals
- 9 Contact brass, gold plated (1,27 micron gold) + tin plated terminals (single pole only)

### PLUNGERS



Standard plunger colour is black.

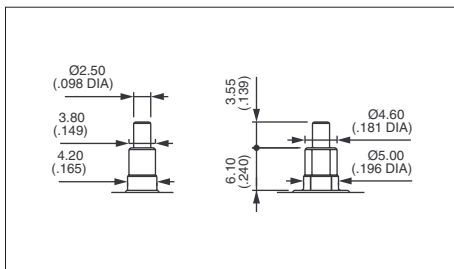

Short - standard

With blue  
case  
**30**

With black  
case  
**80**

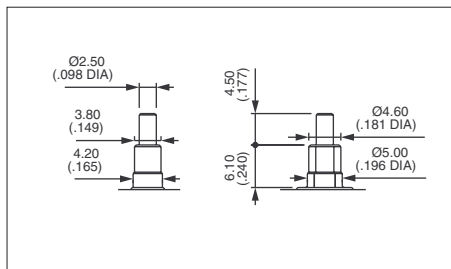

Long

With blue  
case  
**35**

With black  
case  
**85**

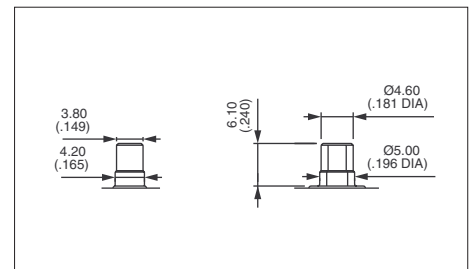

Flush

With black  
case  
**82**

### SPECIAL OPTIONS

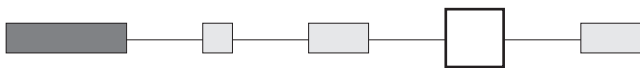

- 00 No special requirement
- 07 **Trimmed terminals** - length 3,2 mm (.125) for TP..WW models only
- 08 **Extended terminals** for TP..WO models only

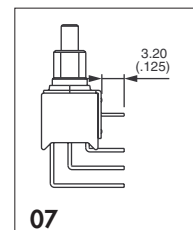

07

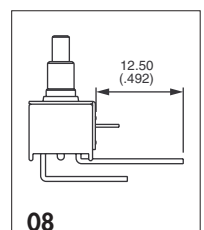

08

# TP series

Tiny washable momentary pushbutton switches

OPTIONS



## SPECIAL OPTIONS (continued)

- 18** Switch **without ground plate** for TP..WW models only
- 20** **Ground plate with 2 pins** for TP..WW models only
- 25** **Trimmed terminals** - length 5 mm (.196) for all models, except TP..WW
- 30** **Wire-wrap terminals** on models with mounting **bracket**
- 40** With cap U3500 mounted over plunger and bushing  
Further protects the switch during PCB processing
- 50** **Crimping of ground plate pins.**  
Retains switch on PC during handling and wave soldering.  
For models TP..WO, TP..WW and TP..YO single and double pole.

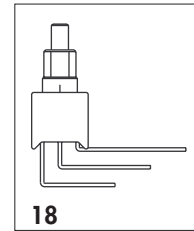

18

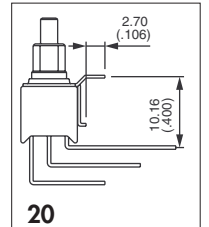

20

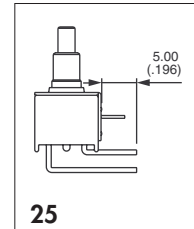

25

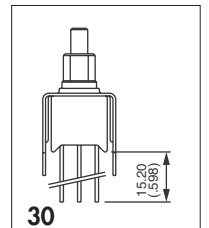

30

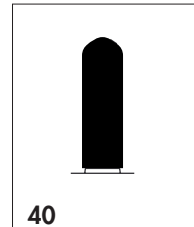

40

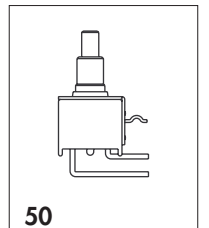

50

## CAPS

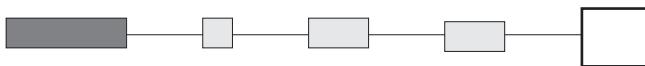

Blank Without cap

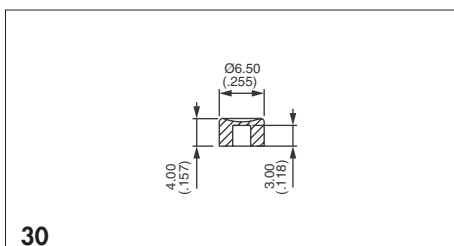

30

P/N U4310 - for long plunger only

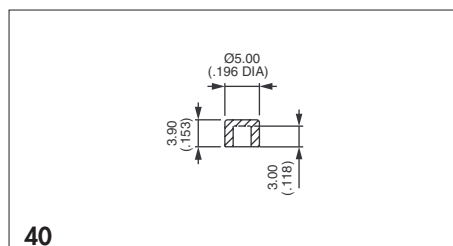

40

P/N U4320 - for long plunger only

To order caps separately, use their part number (U...).

### Cap colours

Replace "0" by number

- |     |           |
|-----|-----------|
| 1   | blue      |
| 1/4 | dark blue |
| 2   | black     |
| 3   | green     |
| 4   | grey      |
| 5   | yellow    |
| 6   | red       |
| 7   | ivory     |
| 7/1 | white     |
| 9   | orange    |