

REVISION AP

DO NOT SCALE FROM THIS PRINT

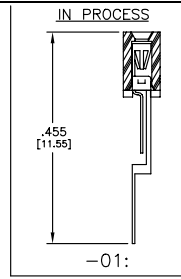
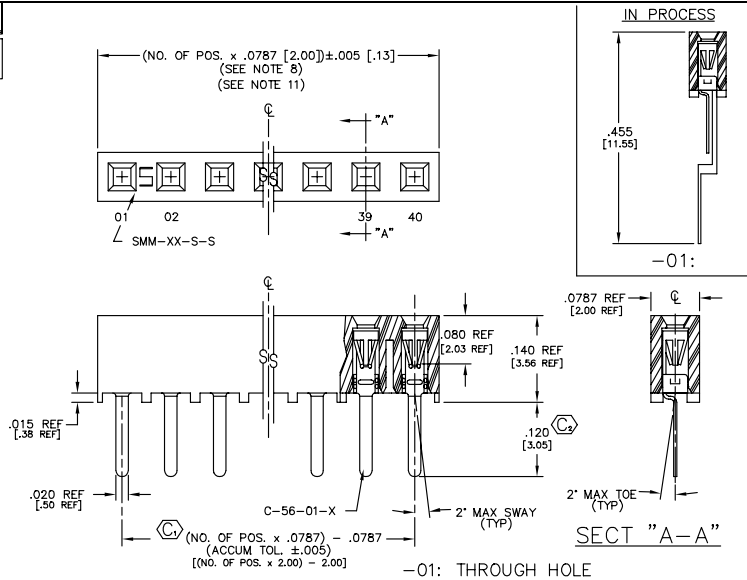

NOTES:

1. RETENTION FORCE IN BODY TO BE: 1 lbs. MIN
2. INSERTION FORCE TO BE: 3.0 oz. MAX.
3. WITHDRAWAL FORCE TO BE: 0.4 oz. MIN.
4. Ⓞ REPRESENTS CRITICAL DIMS. FOR STATISTICAL PROCESS CONTROL.
5. [] DIMS ARE IN METRIC AND ARE NOT CONTROLLING DIMS.
- 6.) SMM-105-01-X THRU SMM-140-01-X MUST USE PT-1-24-01-12.
- 7.) -LC" OPTION FOR A 02 POSITION WILL HAVE ONLY ONE LOCKING CLIP (LC-05-T).
- 8.) "END WALLS" AFTER CUTTING SHOULD BE .017±.005.
- 9.) ALL OPTIONS: PACKAGE POSITIONS -04 THRU -40 IN TUBES. LAYER PACKAGE POSITIONS -02 & -03 WITH NO OPTIONS.
- 10.) -02 THRU -05 POSITION WITH -K OR -P TO BE PACKAGED IN -TR ONLY. -06 THRU -40 POSITION AVAILABLE IN TUBE OR -TR PACKAGING.
- 11.) MAX CUT FLASH: .010[.25]

TUBE PACKAGING TABLE

LEAD STYLE	TUBE	PLUG
-01	PT-1-24-01-12	TP-12
-01-P	PT-1-24-02-29	TP-24
-02	PT-1-24-01-16	TP-12
-02-K, -02-LC, -02-LC-K	PT-1-24-02-29	TP-24
-02-P	PT-1-24-07-09	TP-24-02

DIMENSIONS ARE IN INCHES		UNLESS OTHERWISE NOTED		TOLERANCES ARE:		TITLE: 2 mm SOCKET STRIP (SINGLE ROW)		DWG NO: SMM-1XX-XX-XX-S-XX-X-XX-XX
ONE PLACE DECIMALS: ± .1	TWO PLACE DECIMALS: ± .01	THREE PLACE DECIMALS: ± .005	FOUR PLACE DECIMALS: ± .0020	ANGLES: ± 1°				SHEET 1 OF 1

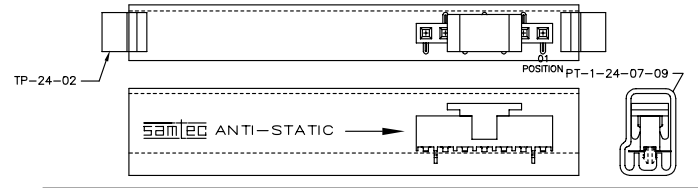
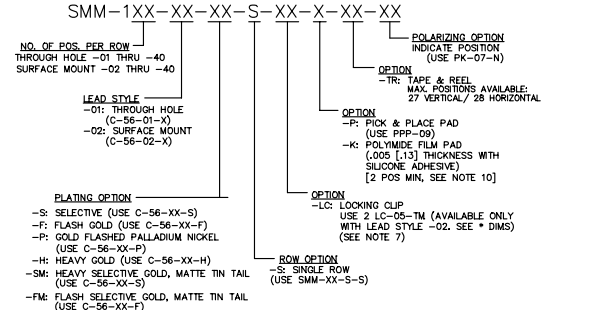

* PINS INTERLEAVED AND ORIENTED SAME DIRECTION FOR -01 ONLY

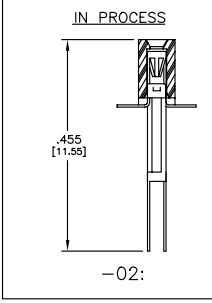
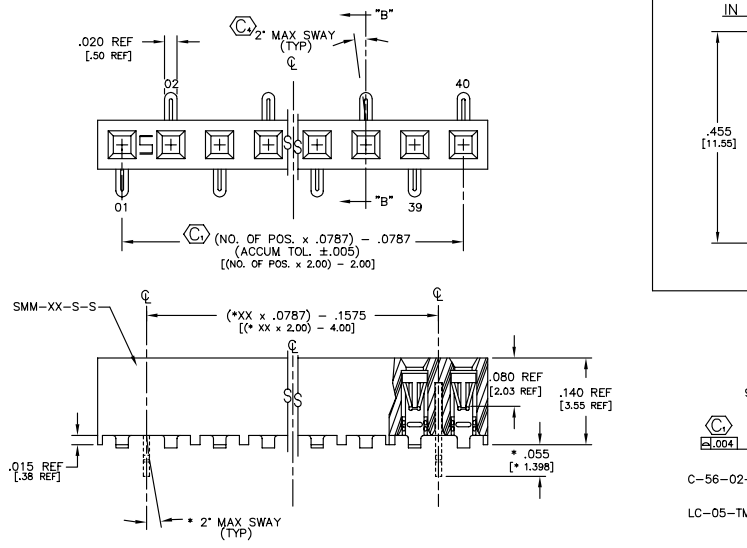

PACKAGE PARTS IN TUBE AS SHOWN (POSITION PARTS WITH POS. -01 TOWARD ARROW AS SHOWN)

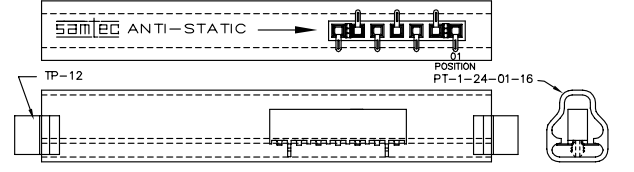

PROPRIETARY NOTE
THIS DOCUMENT CONTAINS PROPRIETARY INFORMATION AND IS NOT TO BE REPRODUCED OR TRANSMITTED IN ANY FORM OR BY ANY MEANS, ELECTRONIC OR MECHANICAL, INCLUDING PHOTOCOPYING, RECORDING, OR BY ANY INFORMATION STORAGE AND RETRIEVAL SYSTEM, WITHOUT THE WRITTEN CONSENT OF SAMTEC INC.

-02: SURFACE MOUNT

SECT "B-B"

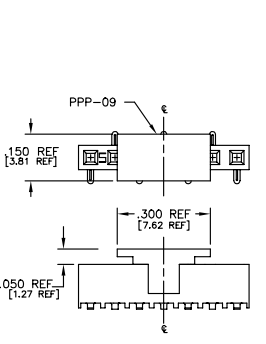

-P: PICK AND PLACE PAD (PLACE PPP-09 ABOUT C.L. AS SHOWN)

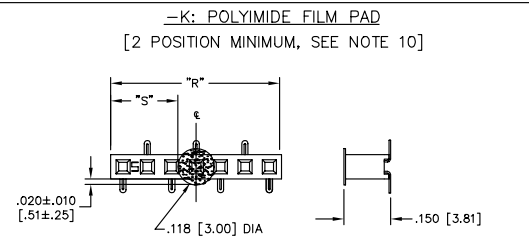

NOTE: "R" = USED MEASURED DIMENSION (REF)
"S" = {("R" - .118 [3.0]) / 2} ± .020 [.51]
1/2 SCALE

EXISPROD/ASSEMBLY/2MM/SMM/SM-SH-5

samtec

520 PARK EAST BLVD., NEW ALBANY, INDIANA 47150
PHONE (812) 944-6733 F.O. BOX 1147
CODE 55322

MADE BY: WATT, KOLB S-22-01
CHECKED BY: MCCARTIN

DESIGN APPROVAL: DEM

SMM-1XX-XX-XX-S-XX-X-XX-XX
SHEET 1 OF 1