

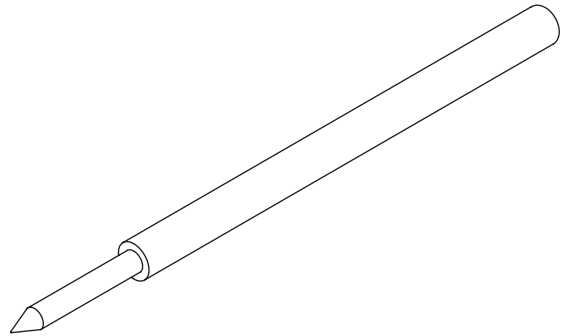

TSF-0,8-5

Set of five spring tips 0.8 mm



PMKs signature feature – spring loaded, needle sharp tips – for precise and safe measurements minimizing the risk of slipping off the board and producing a short circuit.

Materials: gold plated brass; CuBe alloy (Copper Beryllium)

Order-No. 891-005-803

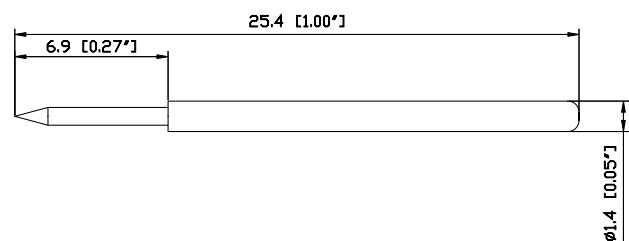

PMK GmbH
Mess- und
Kommunikationstechnik
Industriestr. 17
63150 Heusenstamm
Germany

Phone: +49 (0) 6104 6453
Fax: +49 (0) 6104 6457
Internet: www.pmk.de
E-Mail: sales@pmk.de
service@pmk.de