



USB PORT TRANSIENT SUPPRESSORS

FEATURES

- Design to Protect Submicron 3-V or 5-V Circuits from Noise Transients
- Port ESD Protection Capability Exceeds:
 - 15-kV Human Body Model
 - 2-kV Machine Model
- Available in a WCSP Chip-Scale Package
- Stand-Off Voltage . . . 6.0 V Min
- Low Current Leakage . . . 1 μ A Max at 6 V
- Low Capacitance . . . 35 pF Typ

DESCRIPTION

The SN65220 is a single transient voltage suppressor and the SN65240 and SN75240 are dual transient voltage suppressors designed to provide electrical noise transient protection to Universal Serial Bus (USB) 1.1 ports. Note that the input capacitance of the device makes it unsuitable for high-speed USB 2.0 applications.

Any cabled I/O can be subjected to electrical noise transients from various sources. These noise transients can cause damage to the USB transceiver and/or the USB ASIC if they are of sufficient magnitude and duration.

USB ports are typically implemented in 3-V or 5-V digital CMOS with very limited ESD protection. The SN65220, SN65240, and SN75240 can significantly increase the port ESD protection level and reduce the risk of damage to the circuits of the USB port.

The IEC1000-4-2 ESD performance of the SN65220, SN65240, and SN75240 is measured at the system level. Therefore, system design impacts the results of these tests. A high compliance level may be attained with proper board design and layout.

EQUIVALENT SCHEMATIC DIAGRAM

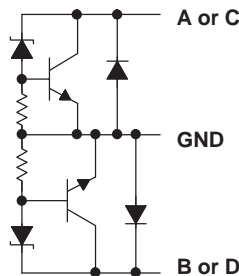

(One Suppressor Shown)

NOTE: All GND terminals should be connected to ground.

APPLICATIONS

- USB 1.1 Host, Hub, or Peripheral Ports

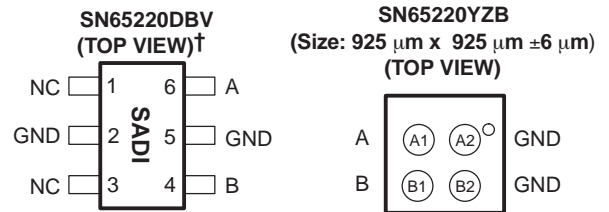

NC – No internal connection
†When read horizontally, Pin 1 is the bottom left pin.

SN65240P, SN65240PW
SN75240P, SN75240PW
(TOP VIEW)



CURRENT vs VOLTAGE

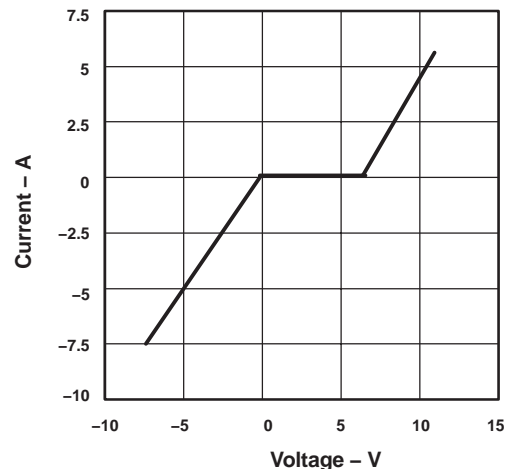

NOTE A: Typical current versus voltage curve was derived using the IEC 1.2/50- μ s surge waveform.



Please be aware that an important notice concerning availability, standard warranty, and use in critical applications of Texas Instruments semiconductor products and disclaimers thereto appears at the end of this data sheet.



This integrated circuit can be damaged by ESD. Texas Instruments recommends that all integrated circuits be handled with appropriate precautions. Failure to observe proper handling and installation procedures can cause damage.

IEC1000-4-2 COMPLIANCE LEVEL

IEC1000-4-2 COMPLIANCE LEVEL	MAXIMUM TEST VOLTAGE	
	CONTACT DISCHARGE (kV)	AIR DISCHARGE (kV)
1	2	2
2	4	4
3	6	8
4	8	15

PACKAGE/ORDERING INFORMATION

PRODUCT	SUPRESSORS	T _A	PACKAGE	PACKAGE DESIGNATOR	MARKED AS	ORDER NUMBER
SN65220	1	-40°C to 85°C	WCSP-4	YZB	NWP or 65220	SN65220YZBR (Reel)
						SN65220YZBT (Mini Reel)
			SOT23-6	DBV	SADI	SN65220DBVR (Mini Reel)
						SN65220DBVT (Mini Reel)
SN65240	2	-40°C to 85°C	DIP-8	P	A65240	SN65240P (Rail)
			TSSOP-8	PW		SN65240PW (Rail)
						SN65240PWR (Reel)
SN75240	2	0°C to 70°C	DIP-8	P	A75240	SN75240P (Rail)
			TSSOP-8	PW		SN75240PW (Rail)
						SN75240PWR (Reel)

ABSOLUTE MAXIMUM RATINGS

over operating free-air temperature range unless otherwise noted⁽¹⁾

	UNIT
Continuous power dissipation	See Dissipation Rating Table
Electrostatic discharge	15 kV ⁽²⁾ , 2 kV ⁽³⁾
Peak power dissipation, P _{D(peak)}	60 W
Peak forward surge current, I _{FSM}	3 A
Peak reverse surge current, I _{RSM}	-9 A
Storage temperature range, T _{stg}	-65°C to 150°C

(1) Stresses above these ratings may cause permanent damage. Exposure to absolute maximum conditions for extended periods may degrade device reliability. These are stress ratings only, and functional operation of the device at these or any other conditions beyond those specified is not implied.

(2) Human Body Model – Tested in accordance with JEDEC Standard 22, Test Method A114-A.

(3) Charged Device Model – Tested in accordance with JEDEC Standard 22, Test Method C101.

DISSIPATION RATING TABLE

PACKAGE	T _A ≤ 25°C POWER RATING	DERATING FACTOR ABOVE T _A = 25°C‡	T _A = 70°C POWER RATING	T _A = 85°C POWER RATING
DBV	385 mW	3.1 mW/°C	246 mW	200 mW
P	1150 mW	9.2 mW/°C	736 mW	598 mW
PW	520 mW	4.2 mW/°C	331 mW	268 mW

‡ This is the inverse of the junction-to-ambient thermal resistance when board-mounted and with no air flow.

recommended operating conditions

		MIN	MAX	UNIT
Operating free-air temperature, T _A	SN75240	0	70	°C
	SN65220, SN65240	-40	85	

electrical characteristics over recommended operating conditions (unless otherwise noted)

PARAMETER	TEST CONDITIONS	MIN	TYP	MAX	UNIT
I _{lkg} Leakage current	V _I = 6 V at A, B, C, or D terminals			1	μA
V _(BR) Breakdown voltage	V _I = 1 mA at A, B, C, or D terminals	6.5	7	8	V
C _{IN} Input capacitance to ground	V _I = 0.4 sin(4E6πt) + 0.5 V		35		pF

APPLICATION INFORMATION

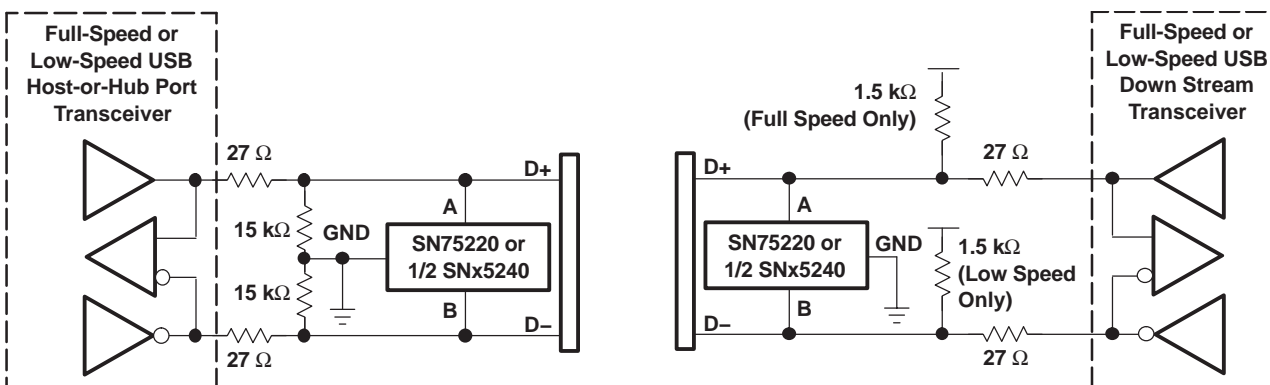

P (R-PDIP-T8)

PLASTIC DUAL-IN-LINE



- NOTES: A. All linear dimensions are in inches (millimeters).
 B. This drawing is subject to change without notice.
 C. Falls within JEDEC MS-001

For the latest package information, go to http://www.ti.com/sc/docs/package/pkg_info.htm



PW (R-PDSO-G**)

PLASTIC SMALL-OUTLINE PACKAGE

14 PINS SHOWN





4040064/F 01/97

- NOTES: A. All linear dimensions are in millimeters.
 B. This drawing is subject to change without notice.
 C. Body dimensions do not include mold flash or protrusion not to exceed 0,15.
 D. Falls within JEDEC MO-153

YZB (S-XBGA-N4)

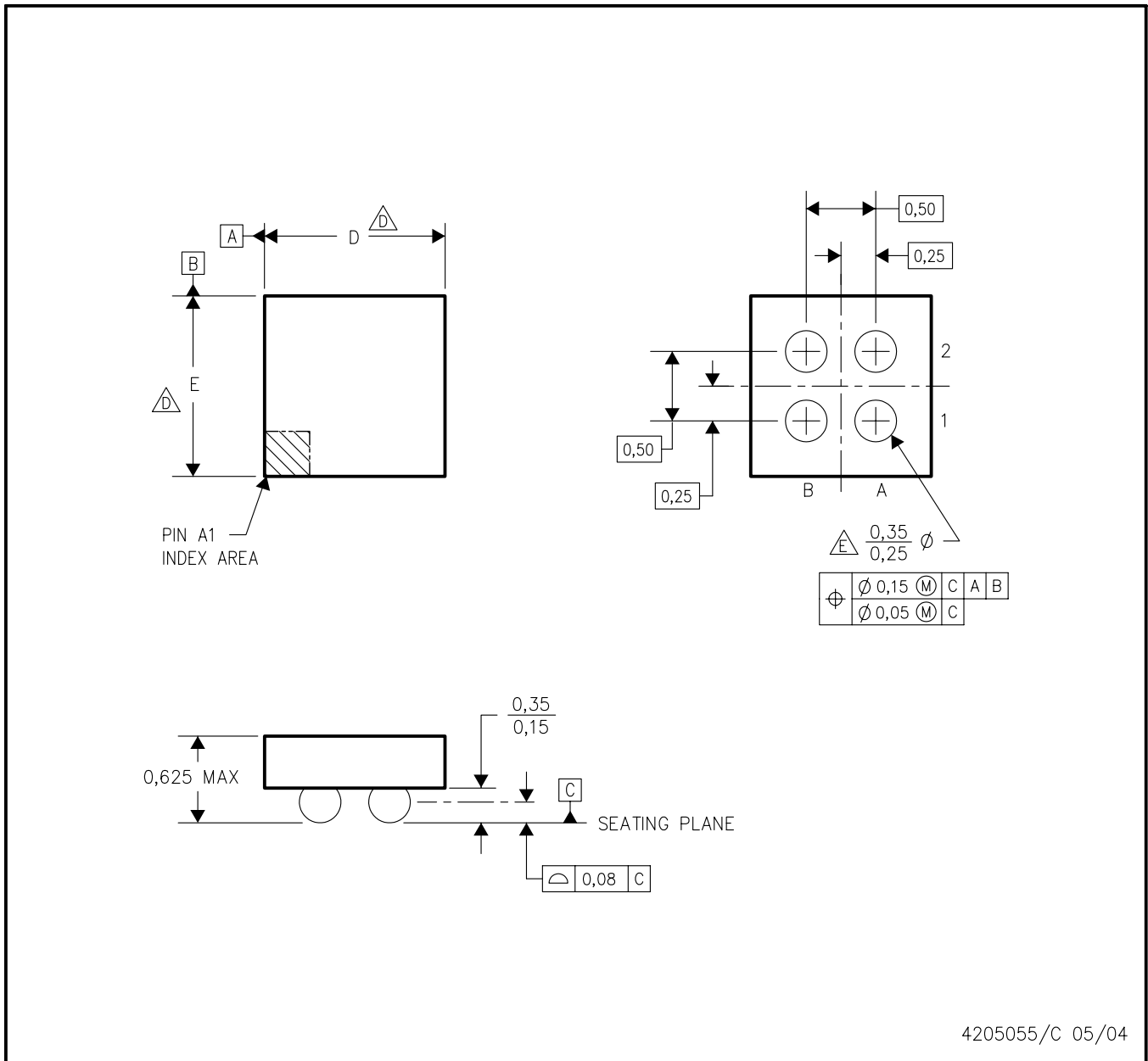
DIE-SIZE BALL GRID ARRAY



- NOTES:
- A. All linear dimensions are in millimeters.
 - B. This drawing is subject to change without notice.
 - C. NanoFree™ package configuration.
 -  D. Devices in YZB package can have dimension D ranging from 0.85 to 1.65 mm and dimension E ranging from 0.85 to 1.65 mm. To determine the exact package size of a particular device, refer to the device datasheet or contact a local TI representative.
 -  E. Reference Product Data Sheet for array population. 2 x 2 matrix is shown for illustration only.
 - F. This package contains lead-free balls. Refer to YEB (Drawing #4204178) for tin-lead (SnPb) balls.

IMPORTANT NOTICE

Texas Instruments Incorporated and its subsidiaries (TI) reserve the right to make corrections, modifications, enhancements, improvements, and other changes to its products and services at any time and to discontinue any product or service without notice. Customers should obtain the latest relevant information before placing orders and should verify that such information is current and complete. All products are sold subject to TI's terms and conditions of sale supplied at the time of order acknowledgment.

TI warrants performance of its hardware products to the specifications applicable at the time of sale in accordance with TI's standard warranty. Testing and other quality control techniques are used to the extent TI deems necessary to support this warranty. Except where mandated by government requirements, testing of all parameters of each product is not necessarily performed.

TI assumes no liability for applications assistance or customer product design. Customers are responsible for their products and applications using TI components. To minimize the risks associated with customer products and applications, customers should provide adequate design and operating safeguards.

TI does not warrant or represent that any license, either express or implied, is granted under any TI patent right, copyright, mask work right, or other TI intellectual property right relating to any combination, machine, or process in which TI products or services are used. Information published by TI regarding third-party products or services does not constitute a license from TI to use such products or services or a warranty or endorsement thereof. Use of such information may require a license from a third party under the patents or other intellectual property of the third party, or a license from TI under the patents or other intellectual property of TI.

Reproduction of information in TI data books or data sheets is permissible only if reproduction is without alteration and is accompanied by all associated warranties, conditions, limitations, and notices. Reproduction of this information with alteration is an unfair and deceptive business practice. TI is not responsible or liable for such altered documentation.

Resale of TI products or services with statements different from or beyond the parameters stated by TI for that product or service voids all express and any implied warranties for the associated TI product or service and is an unfair and deceptive business practice. TI is not responsible or liable for any such statements.

Following are URLs where you can obtain information on other Texas Instruments products and application solutions:

Products		Applications	
Amplifiers	amplifier.ti.com	Audio	www.ti.com/audio
Data Converters	dataconverter.ti.com	Automotive	www.ti.com/automotive
DSP	dsp.ti.com	Broadband	www.ti.com/broadband
Interface	interface.ti.com	Digital Control	www.ti.com/digitalcontrol
Logic	logic.ti.com	Military	www.ti.com/military
Power Mgmt	power.ti.com	Optical Networking	www.ti.com/opticalnetwork
Microcontrollers	microcontroller.ti.com	Security	www.ti.com/security
		Telephony	www.ti.com/telephony
		Video & Imaging	www.ti.com/video
		Wireless	www.ti.com/wireless

Mailing Address: Texas Instruments
Post Office Box 655303 Dallas, Texas 75265