

Blinking LED in \varnothing 5 mm Plastic Package

Features

- Plastic case, colored diffuse
- Vibration resistant
- Built-in blink-function P-MOS IC $f \approx 3$ Hz
- Supply voltage $V_S = 5$ V
- Wide viewing angle $\varphi = \pm 40^\circ$
- Cycle start in lighted phase
- Built-in current limiter
- Lead-free device

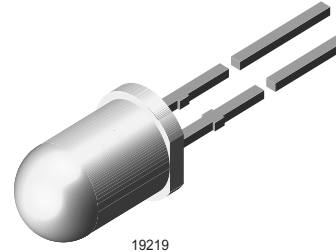

19219



Applications

Blink function display

Parts Table

Part	Color, Luminous Intensity	Angle of Half Intensity ($\pm\varphi$)	Technology
TLBR5410	Red, $I_V > 1$ mcd	40°	GaAsP on GaAsP/P-MOS

Absolute Maximum Ratings

$T_{amb} = 25^\circ\text{C}$, unless otherwise specified

TLBR5410

Parameter	Test condition	Symbol	Value	Unit
Reverse voltage	Pin $+V_S$	V_R	0.4	V
Supply voltage	Pin $+V_S$	V_S	7	V
Total power dissipation	$T_{amb} \leq 70^\circ\text{C}$	P_{tot}	200	mW
Junction temperature		T_j	100	$^\circ\text{C}$
Operating temperature range		T_{amb}	- 40 to + 70	$^\circ\text{C}$
Storage temperature range		T_{stg}	- 55 to + 100	$^\circ\text{C}$
Soldering temperature	$t \leq 5$ s, 2 mm from case	T_{sd}	260	$^\circ\text{C}$

Optical and Electrical Characteristics

$T_{amb} = 25\text{ }^{\circ}\text{C}$, unless otherwise specified

Red

TLBR5410

Parameter	Test condition	Symbol	Min	Typ.	Max	Unit
Luminous intensity ¹⁾	$V_S = 5\text{ V}$	I_V	1	1.6		mcd
Peak wavelength	$V_S = 5\text{ V}$	λ_p		640		nm
Spectral line half width	$V_S = 5\text{ V}$	$\Delta\lambda$		20		nm
Angle of half intensity	$V_S = 5\text{ V}$	φ		± 40		deg
Supply voltage range	$V_S = 5\text{ V}$	V_S	4.75		7	V
Supply current	$V_S = 5\text{ V}$	I_{Son}	10		30	mA
		I_{Soff}			2	mA
Blink frequency	$T_{amb} = 25\text{ }^{\circ}\text{C}$	f_{bl}	1.3		5.2	Hz
	$T_{amb} = (-40\text{ to }+70)\text{ }^{\circ}\text{C}$	f_{bl}	1.1		7.2	Hz
ON/OFF-ratio		t_{on}/t_{off}		33 to 67		%

¹⁾ in one Packing Unit $I_{Vmin}/I_{Vmax} \leq 0.5$

Typical Characteristics ($T_{amb} = 25\text{ }^{\circ}\text{C}$ unless otherwise specified)

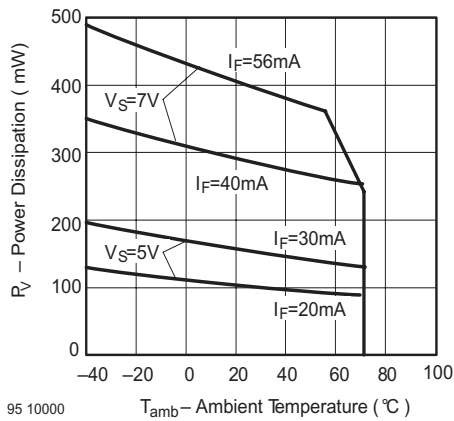

Figure 1. Power Dissipation vs. Ambient Temperature

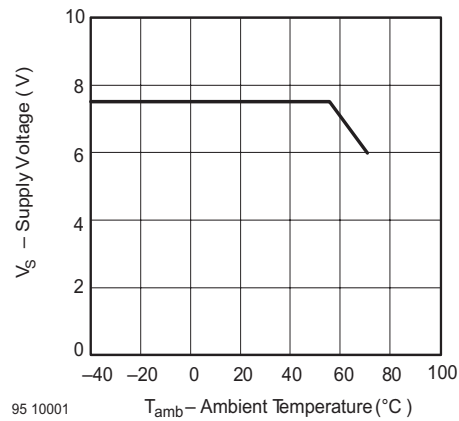

Figure 2. Supply Voltage vs. Ambient Temperature

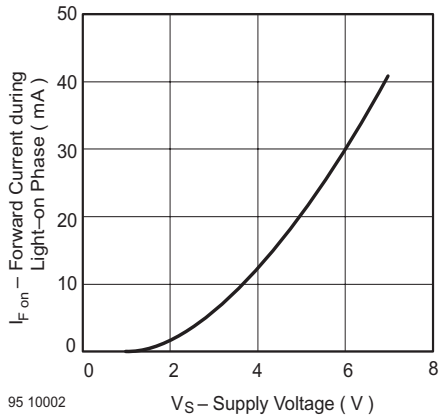

Figure 3. Forward Current (Light On) vs. Supply Voltage

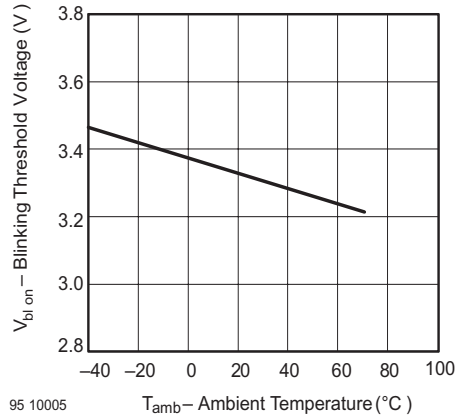

Figure 6. Blinking Threshold Voltage vs. Amb. Temperature

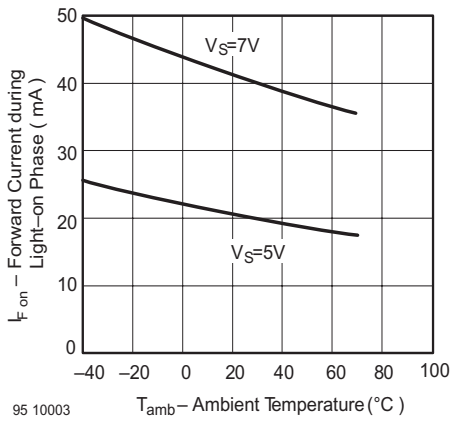

Figure 4. Forward Current (Light On) vs. Amb. Temperature

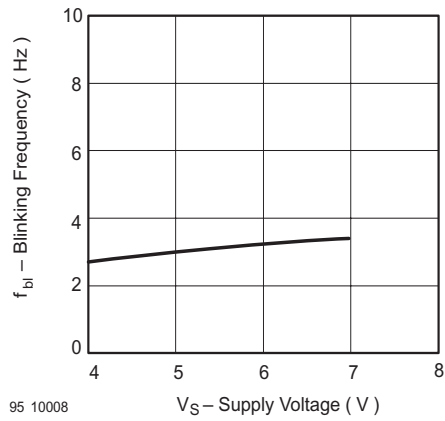

Figure 7. Blinking Frequency vs. Supply Voltage

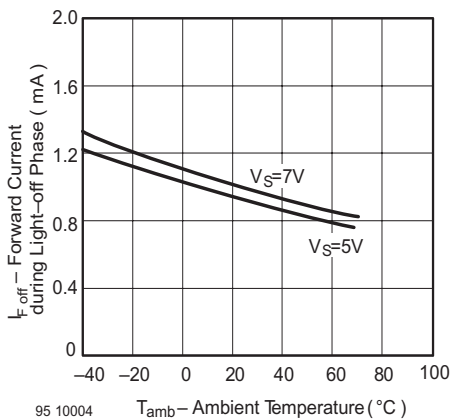

Figure 5. Forward Current (Light Off) vs. Amb. Temperature

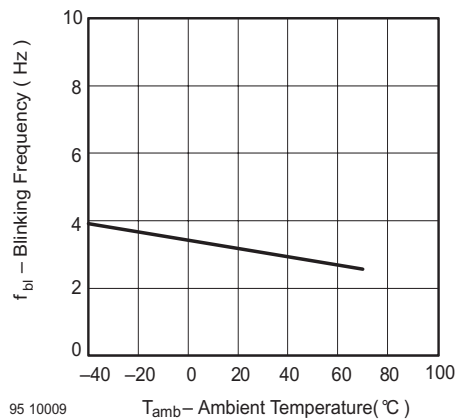

Figure 8. Blinking Frequency vs. Ambient Temperature

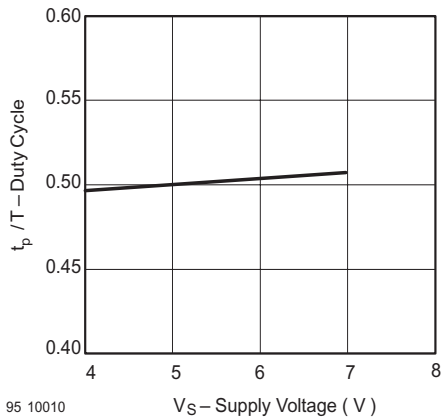

Figure 9. Duty Cycle vs. Supply Voltage

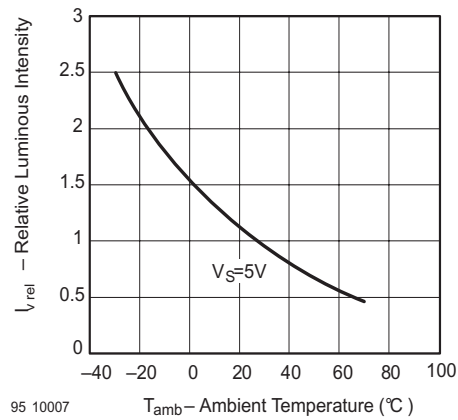

Figure 12. Relative Luminous Intensity vs. Amb. Temperature

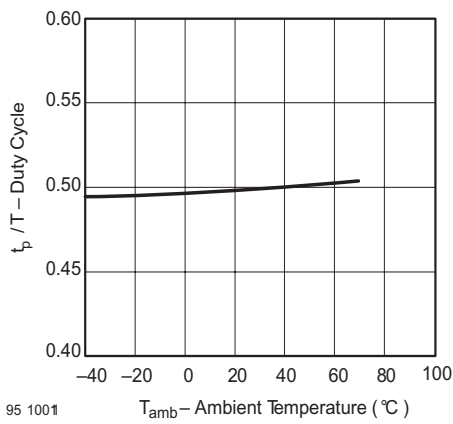

Figure 10. Duty Cycle vs. Ambient Temperature

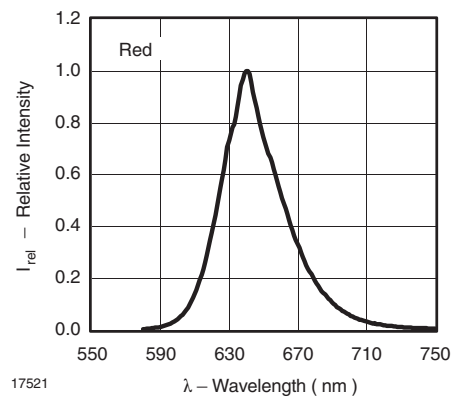

Figure 13. Relative Intensity vs. Wavelength

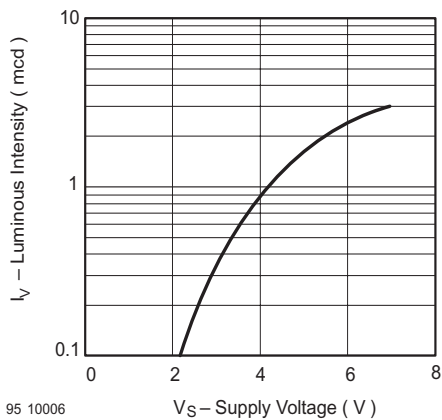

Figure 11. Luminous Intensity vs. Supply Voltage

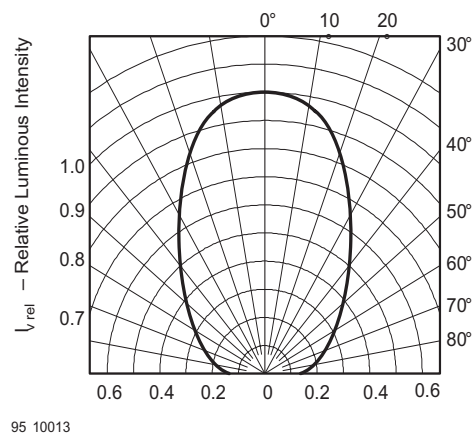
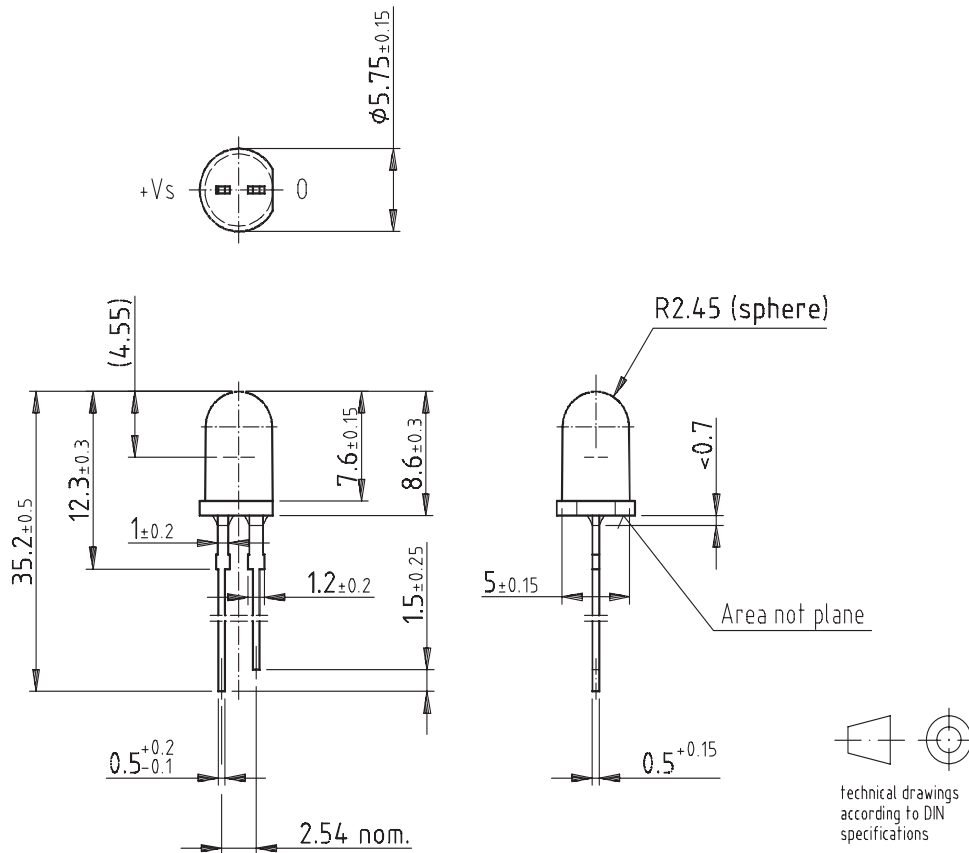

Figure 14. Rel. Luminous Intensity vs. Angular Displacement

Package Dimensions in mm



95 11264

Ozone Depleting Substances Policy Statement

It is the policy of **Vishay Semiconductor GmbH** to

1. Meet all present and future national and international statutory requirements.
2. Regularly and continuously improve the performance of our products, processes, distribution and operating systems with respect to their impact on the health and safety of our employees and the public, as well as their impact on the environment.

It is particular concern to control or eliminate releases of those substances into the atmosphere which are known as ozone depleting substances (ODSs).

The Montreal Protocol (1987) and its London Amendments (1990) intend to severely restrict the use of ODSs and forbid their use within the next ten years. Various national and international initiatives are pressing for an earlier ban on these substances.

Vishay Semiconductor GmbH has been able to use its policy of continuous improvements to eliminate the use of ODSs listed in the following documents.

1. Annex A, B and list of transitional substances of the Montreal Protocol and the London Amendments respectively
2. Class I and II ozone depleting substances in the Clean Air Act Amendments of 1990 by the Environmental Protection Agency (EPA) in the USA
3. Council Decision 88/540/EEC and 91/690/EEC Annex A, B and C (transitional substances) respectively.

Vishay Semiconductor GmbH can certify that our semiconductors are not manufactured with ozone depleting substances and do not contain such substances.

**We reserve the right to make changes to improve technical design
and may do so without further notice.**

Parameters can vary in different applications. All operating parameters must be validated for each customer application by the customer. Should the buyer use Vishay Semiconductors products for any unintended or unauthorized application, the buyer shall indemnify Vishay Semiconductors against all claims, costs, damages, and expenses, arising out of, directly or indirectly, any claim of personal damage, injury or death associated with such unintended or unauthorized use.

Vishay Semiconductor GmbH, P.O.B. 3535, D-74025 Heilbronn, Germany
Telephone: 49 (0)7131 67 2831, Fax number: 49 (0)7131 67 2423



Notice

Specifications of the products displayed herein are subject to change without notice. Vishay Intertechnology, Inc., or anyone on its behalf, assumes no responsibility or liability for any errors or inaccuracies.

Information contained herein is intended to provide a product description only. No license, express or implied, by estoppel or otherwise, to any intellectual property rights is granted by this document. Except as provided in Vishay's terms and conditions of sale for such products, Vishay assumes no liability whatsoever, and disclaims any express or implied warranty, relating to sale and/or use of Vishay products including liability or warranties relating to fitness for a particular purpose, merchantability, or infringement of any patent, copyright, or other intellectual property right.

The products shown herein are not designed for use in medical, life-saving, or life-sustaining applications. Customers using or selling these products for use in such applications do so at their own risk and agree to fully indemnify Vishay for any damages resulting from such improper use or sale.