

# MCAK102BSSSWPMM

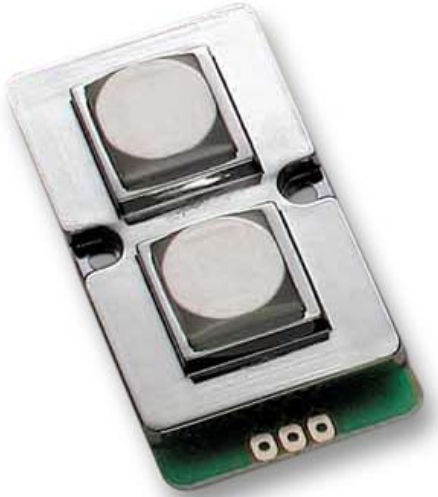

## Keypads



### Specifications:

Contact Rating	: 20mA, 24V dc.
Maximum Contact Resistance	: 200Ω.
Life	: 2,000,000 cycles per key.
Operating Temperature	: -20°C to +60°C.
Storage Temperature	: -40°C to +65°C.

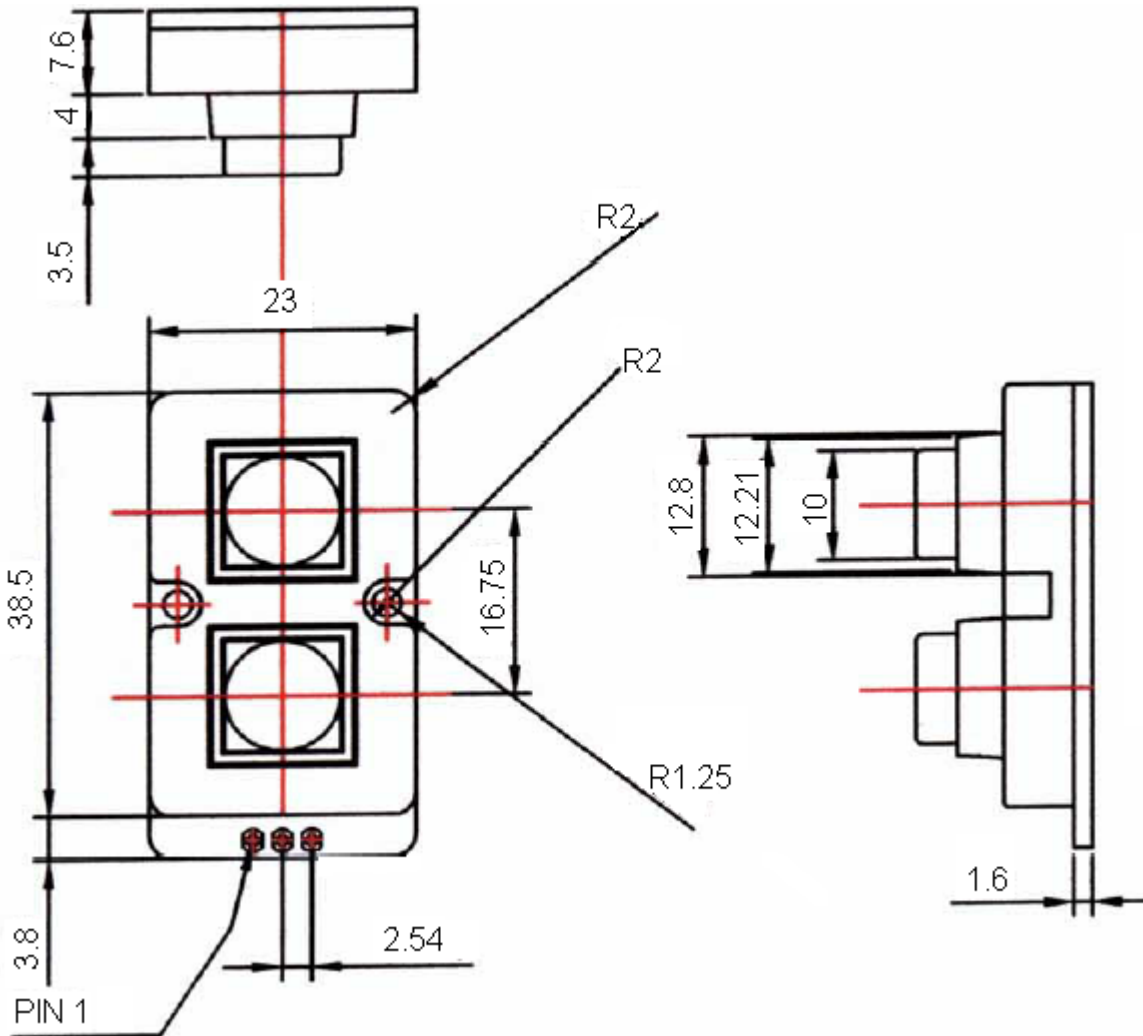

Dimensions : Millimetres



# MCAK102BSSSWPMM



## Keypads

### Part Number Table

Description	Part Number
Keypad, Metal IP67 1 x 2	MCAK102BSSSWPMM



### Notes:

### International Sales Offices:



**AUSTRALIA – Farnell InOne**  
Tel No: ++ 61 2 9645 8888  
Fax No: ++ 61 2 9644 7898



**FINLAND – Farnell InOne**  
Tel No: ++ 358 9 560 7780  
Fax No: ++ 358 9 345 5411



**NETHERLANDS – Farnell InOne**  
Tel No: ++ 31 30 241 7373  
Fax No: ++ 31 30 241 7333



**SWITZERLAND – Farnell InOne**  
Tel No: ++ 41 1 204 64 64  
Fax No: ++ 41 1 204 64 54



**AUSTRIA – Farnell InOne**  
Tel No: ++ 43 662 2180 680  
Fax No: ++ 43 662 2180 670



**FRANCE – Farnell InOne**  
Tel No: ++ 33 474 68 99 99  
Fax No: ++ 33 474 68 99 90



**NEW ZEALAND – Farnell InOne**  
Tel No: ++ 64 9 357 0646  
Fax No: ++ 64 9 357 0656



**UK – Farnell InOne**  
Tel No: ++ 44 8701 200 200  
Fax No: ++ 44 8701 200 201



**BELGIUM – Farnell InOne**  
Tel No: ++ 32 3 475 2810  
Fax No: ++ 32 3 227 3648



**GERMANY – Farnell InOne**  
Tel No: ++ 49 89 61 39 39 39  
Fax No: ++ 49 89 613 59 01



**NORWAY – Farnell InOne**  
Tel No: ++ 45 44 53 66 66  
Fax No: ++ 45 44 53 66 02



**UK – BuckHickman InOne**  
++ 44 8450 510 150  
++ 44 8450 510 130



**BRAZIL – Farnell-Newark InOne**  
Tel No: ++ 55 11 4066 9400  
Fax No: ++ 55 11 4066 9410



**HONG KONG – Farnell-Newark InOne**  
Tel No: ++ 852 2268 9888  
Fax No: ++ 852 2268 9899



**PORTUGAL – Farnell InOne**  
Tel No: ++ 34 93 475 8804  
Fax No: ++ 34 93 474 5288



**UK – CPC**  
++ 44 8701 202 530  
++ 44 8701 202 531



**CHINA – Farnell-Newark InOne**  
Tel No: ++86 10 6238 5152  
Fax No: ++86 10 6238 5022



**IRELAND – Farnell InOne**  
Tel No: ++ 353 1 830 9277  
Fax No: ++ 353 1 830 9016



**SINGAPORE – Farnell-Newark InOne**  
Tel No: ++ 65 6788 0200  
Fax No: ++ 65 6788 0300



**EXPORT – Farnell InOne**  
Tel No: ++ 44 8701 200 208  
Fax No: ++ 44 8701 200 209

For enquiries from all other markets



**DENMARK – Farnell InOne**  
Tel No: ++ 45 44 53 66 44  
Fax No: ++ 45 44 53 66 06



**ITALY – Farnell InOne**  
Tel No: ++ 39 02 93 995 200  
Fax No: ++ 39 02 93 995 300



**SPAIN – Farnell InOne**  
Tel No: ++ 34 93 475 8805  
Fax No: ++ 34 93 474 5107



**ESTONIA – Farnell InOne**  
Tel No: ++ 358 9 560 7780  
Fax No: ++ 358 9 345 5411



**MALAYSIA – Farnell-Newark InOne**  
Tel No: ++ 60 3 7873 8000  
Fax No: ++ 60 3 7873 7000



**SWEDEN – Farnell InOne**  
Tel No: ++ 46 8 730 50 00  
Fax No: ++ 46 8 83 52 62

<http://www.farnellinone.com>

<http://www.buckhickmaninone.com>

<http://www.cpc.co.uk>

**Disclaimer** This data sheet and its contents (the "Information") belong to the Premier Farnell Group (the "Group") or are licensed to it. No licence is granted for the use of it other than for information purposes in connection with the products to which it relates. No licence of any intellectual property rights is granted. The Information is subject to change without notice and replaces all data sheets previously supplied. The Information supplied is believed to be accurate but the Group assumes no responsibility for its accuracy or completeness, any error in or omission from it or for any use made of it. Users of this data sheet should check for themselves the Information and the suitability of the products for their purpose and not make any assumptions based on information included or omitted. Liability for loss or damage resulting from any reliance on the Information or use of it (including liability resulting from negligence or where the Group was aware of the possibility of such loss or damage arising) is excluded. This will not operate to limit or restrict the Group's liability for death or personal injury resulting from its negligence. Multicomp is the registered trademark of the Group. © Premier Farnell plc 2004.