

A Full Line of Highly Functional Models with a Variety of Fiber Units

- Four amplifier models available for covering a wide range of applications.



Features

High-sensitivity Model

E3X-H
High-sensitivity Optical Fiber Photoelectric Sensor



1. Senses Distances Twice as Far as those of Conventional Model

The E3X-H senses distances twice as far as those of the E3X-A. For example, the maximum sensing distance of the through-beam M4 fiber model is 700 mm and that of the reflective model is 200 mm.

2. Incorporates Variable Hysteresis Function

E3X-A11+E32-T11L
Through-beam M4 fiber

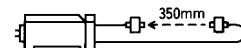

E3X-H11+E32-T11L
Through-beam M4 fiber

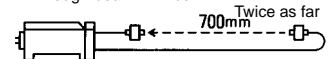

Standard Model

E3X-A
Optical Fiber Photoelectric Sensor



Eight-turn Sensitivity Adjuster Ensures Fine Sensitivity Adjustments

A maximum sensing distance of 350 mm is possible if the long-distance M4 fiber model is used. The E3X-A ensures a high-speed response of 200 μ s, which is ideal for a wide variety of applications.

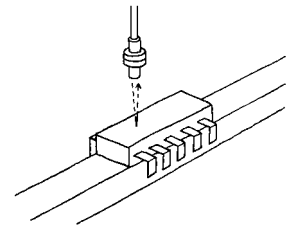

High-speed Model

E3X-F
Optical Fiber Photoelectric Sensor



Pulse Lighting Mechanism Enables a High-speed Response of 20 μ s

The E3X-F has excellent optical characteristics to withstand external disturbance. This model is ideal for the high-speed positioning and detection of minute sensing objects. For example, the E3X-F detects with ease a 1-mm mark on an object on a high-speed line that moves at the rate of 30 m per second.

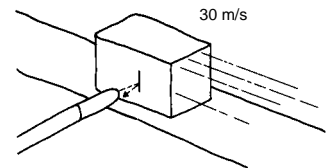

Mark Sensor Model

E3X-VG
Optical Fiber Photoelectric Sensor



Green Light Source Accurately Senses Subtle Differences in Color

Furthermore, the E3X-VG ensures a high-speed response of 200 μ s.

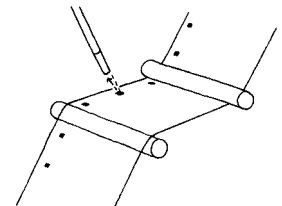

OMRON's unique Fiber Units are available in a wide variety of models that includes 68 standard models and 362 modified models with or without special sleeves.

■ Common Characteristics

Ideal for Worldwide Use

The E3X models other than the E3X-H and E3X-VG have NPN or PNP open collector output, thus ensuring worldwide use with ease. All E3X models are available from OMRON's 44 representatives in 25 countries.

A Series of E3X Models Incorporates a Variable Timer Function

(Except the E3X-H11, which has a built-in 40-ms fixed timer)

A minute, high-speed signal is prolonged by the built-in OFF-delay timer for a certain period, which makes it possible to input the signal directly to Programmable Controllers in various lengths. (The variable timer function is built into the self-diagnostic model.)



Easy Maintenance Ensured by Optical Monitoring

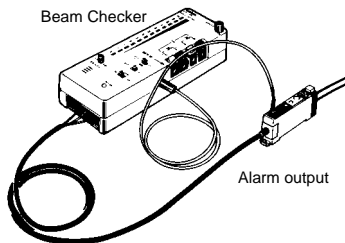

Push Lever Ensures Easy Fiber Connections



IEC60529 IP66 Water-resistant



Flashing Function Ensures Easy Optical Axis Adjustments

The emitter is ON in the operating range and flashes outside the operating range.

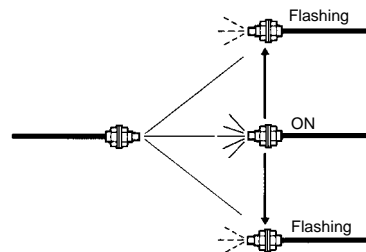

Eight-turn Sensitivity Adjuster Ensures Fine Sensitivity Adjustments

The E3X incorporates an eight-turn sensitivity adjuster and an easy-to-see sensitivity indicator.

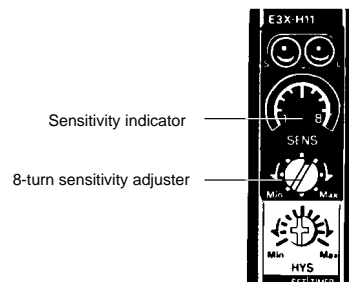

■ LED Indicator Lighting Tests are Possible (E3X-A11-8)

- The E3X-A11-8 makes it possible to conduct lighting tests of LED indicators incorporated by equipment.
- Red flames can be checked as well.

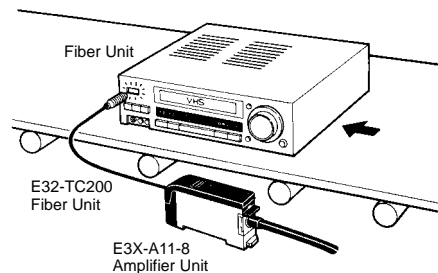

Ordering Information

Model Number Legend:

E3X-□□□□
 1 2 3 4

1. Classification

H: High-sensitivity
 A: General-purpose
 F: Shorter response time
 V: For mark sensor

2. Light Source

None: Red (standard)
 G: Green

3. Outputs

1: NPN (without self-diagnosis)
 2: NPN (with self-diagnosis)
 4: PNP (without self-diagnosis)
 5: PNP (with self-diagnosis)

4. Output Form

1: Cable

■ Accessories

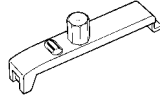
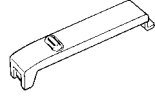
Item	Manual Sensitivity Adjustment Knob	Protective Cover
Application	Makes adjustment possible without screwdriver. Water-resistance lost when used (degree of protection reduced to IEC60529 IP50).	Replacement part for cover supplied with Amplifier Unit.
Model	E39-G3 (see note)	E39-G4 (see note)
Appearance		
Applicable Amplifier Unit	E3X-A/-F/-VG E3X-H	
Sold together/separately	Sold separately	Sold together

Note: The above accessories are not available to the following push-type model.

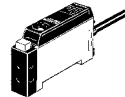

■ Amplifier Units

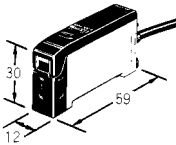

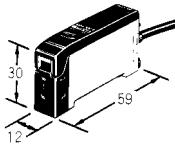







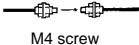

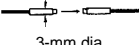

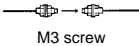

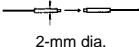

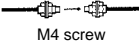

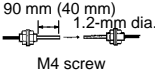

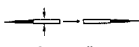
Item	High-sensitivity
Model	E3X-H11
Appearance	
Light source	Red LED (660 nm)
Power supply voltage	10 to 30 VDC \pm 10%, ripple (p-p) 10% max.
Current consumption	35 mA max.
Response time	1 ms max.
Control output	100 mA max. at 30 VDC, NPN open collector, residual output voltage of 1 V max.
Timer function	OFF-delay timer (fixed to 40 ms), switch selectable
Variable hysteresis function	0% to 20%
Alarm output	---
External check input	---

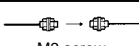
Item		General-purpose		Shorter response time	For mark sensing		
		---	Timer, alarm, and external check functions incorporated	Timer, alarm, and external check functions incorporated	---	Timer, alarm, and external check functions incorporated	
Model	NPN	E3X-A11	E3X-A21	E3X-F21	E3X-VG11	E3X-VG21	
	PNP	E3X-A41	E3X-A51	E3X-F51	---	---	
Appearance							
Light source		Red (660 nm)			Green (565 nm)		
Power supply voltage		10 to 30 VDC ripple (p-p) 10% max.		12 to 24 VDC \pm 10% ripple (p-p) 10% max.	10 to 30 VDC ripple (p-p) 10% max.		
Current consumption		35 mA max.		40 mA max.			
Response time		200 μ s max.		ON: 20 μ s max. OFF: 30 μ s max.	200 μ s max.		
Control output		Open collector output of 100 mA at 30 VDC with a residual voltage of 1 V max.					
Timer function		---	OFF-delay timer (0.01 to 0.1 s; adjustable), Switch selectable	---	OFF-delay timer (0.01 to 0.1 s; adjustable), Switch selectable		
Alarm output		---	50 mA, 30 VDC max. Residual voltage: 1 VDC max.		---	50 mA, 30 VDC max. Residual voltage: 1 VDC max.	
External check input	Input voltage	---	Light OFF: NPN: 1.5 V max; short current: 0.2 mA max. PNP: \pm 1.5 V max.; short current: 0.2 mA max. Light ON: NPN: Open; 3.5 V min. (max. input: 5 V) PNP: Open; \pm 3.5 VDC max. (max. input: 5 V)		---	Light OFF: 1.5 V max; short current: 0.2 mA max. Light ON: Open; 3.5 V min. (max. input: 5 V)	
	Response delay	---	400 μ s	200 μ s	---	400 μ s	

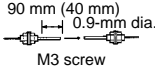
■ Fiber Unit

Through-beam (Separate) Sensor

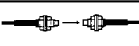

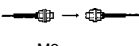











 Indicates models that allow free cutting. Models without this mark do not allow free cutting.

Model	Appearance	Sensing distance (standard object: opaque) (H: E3X-H11; A: E3X-A□□; F: E3X-F□□; V: E3X-VG□□)	Min. sensing object (opaque objects)	Features
E32-T11L 	 M4 screw	H: 700 mm (2,000 mm ^{*1}) (1.4-mm dia. min.) A: 350 mm (1,000 mm ^{*1}) (1.4-mm dia. min.) F: 150 mm (1.4-mm dia. min.) V: 40 mm (120 mm ^{*1}) (1.4-mm dia. min.)	0.5-mm dia.	Long distance
E32-T12L 	 3-mm dia.	H: 700 mm (1.4-mm dia. min.) A: 350 mm (1.4-mm dia. min.) F: 150 mm (1.4-mm dia. min.) V: 40 mm (1.4-mm dia. min.)	0.5-mm dia.	Long distance
E32-T21L 	 M3 screw	H: 200 mm (0.9-mm dia. min.) A: 100 mm (0.9-mm dia. min.) F: 50 mm (0.9-mm dia. min.) V: 10 mm (0.9-mm dia. min.)	0.2-mm dia.	Long distance with thin fiber
E32-T22L 	 2-mm dia.	H: 200 mm (0.9-mm dia. min.) A: 100 mm (0.9-mm dia. min.) F: 50 mm (0.9-mm dia. min.) V: 10 mm (0.9-mm dia. min.)	0.2-mm dia.	Long distance with thin fiber
E32-TC200 	 M4 screw	H: 400 mm (3,000 mm ^{*1}) (1-mm dia. min.) A: 200 mm (1,500 mm ^{*1}) (1-mm dia. min.) F: 80 mm (1-mm dia. min.) V: 28 mm (190 mm ^{*1}) (1-mm dia. min.)	0.2-mm dia.	General-purpose
E32-TC200B E32-TC200B4 	 90 mm (40 mm) 1.2-mm dia. M4 screw Figures in parentheses are for the B4 model.	H: 400 mm (1-mm dia. min.) A: 180 mm (1-mm dia. min.) F: 80 mm (1-mm dia. min.) V: 28 mm (1-mm dia. min.)	0.2-mm dia.	General-purpose
E32-T22 	 2-mm dia.	H: 100 mm (0.5-mm dia. min.) A: 50 mm (0.5-mm dia. min.) F: 26 mm (0.5-mm dia. min.) V: 7 mm (0.5-mm dia. min.)	0.1-mm dia.	General-purpose
E32-TC200E 	 M3 screw	H: 100 mm (0.5-mm dia. min.) A: 50 mm (0.5-mm dia. min.) F: 26 mm (0.5-mm dia. min.) V: 8 mm (0.5-mm dia. min.)	0.1-mm dia.	General-purpose
E32-TC200F E32-TC200F4 	 90 mm (40 mm) 0.9-mm dia. M3 screw Figures in parentheses are for the F4 model.	H: 100 mm (0.5-mm dia. min.) A: 50 mm (0.5-mm dia. min.) F: 26 mm (0.5-mm dia. min.) V: 8 mm (0.5-mm dia. min.)	0.1-mm dia.	General-purpose
E32-TC200A 	 M3 screw	H: 360 mm (1-mm dia. min.) A: 180 mm (1-mm dia. min.) F: 80 mm (1-mm dia. min.) V: 28 mm (1-mm dia. min.)	H: 0.3-mm dia. A: 0.2-mm dia. F: 0.2-mm dia. V: 0.2-mm dia.	For attachment E39-F5
E32-T11 	 M4 screw	H: 360 mm (1-mm dia. min.) A: 180 mm (1,000 mm ^{*1}) (1-mm dia. min.) F: 80 mm (1-mm dia. min.) V: 10 mm (120 mm ^{*1}) (1-mm dia. min.)	H: 0.3-mm dia. A: 0.2-mm dia. F: 0.2-mm dia. V: 0.2-mm dia.	Flexible (resists breaking)
E32-T21 	 M3 screw	H: 100 mm (0.5-mm dia. min.) A: 50 mm (0.5-mm dia. min.) F: 26 mm (0.5-mm dia. min.) V: 6 mm (0.5-mm dia. min.)	0.1-mm dia.	Flexible (resists breaking)

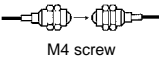
Note: Curled-cord type is also available for through-beam and reflective models.

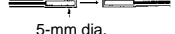
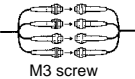
*1 For the E39-F1

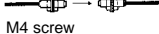
 Indicates models that allow free cutting. Models without this mark do not allow free cutting.

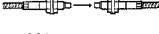
Model	Appearance	Sensing distance (standard object: opaque) (H: E3X-H11; A: E3X-A□□; F: E3X-F□□; V: E3X-VG□□)	Min. sensing object (opaque objects)	Features
E32-T14L 	3-mm dia. 	H: 240 mm (1-mm dia. min.) A: 120 mm (1-mm dia. min.) F: 30 mm (1-mm dia. min.) V: 10 mm (1-mm dia. min.)	H: 0.2-mm dia. A: 0.1-mm dia. F: 0.2-mm dia. V: 0.1-mm dia.	Side-view; long distance
E32-T24 	1-mm dia. 	H: 90 mm (0.5-mm dia. min.) A: 45 mm (0.5-mm dia. min.) F: 15 mm (0.5-mm dia. min.) V: 2 mm (0.5-mm dia. min.)	H: 0.1-mm dia. A: 0.1-mm dia. F: 0.3-mm dia. V: 0.2-mm dia.	Side-view; save space
E32-T14 		H: 1,800 mm (4-mm dia. min.) A: 900 mm (4-mm dia. min.) F: 380 mm (4-mm dia. min.) V: 80 mm (4-mm dia. min.)	0.2-mm dia.	Side-view, screw tightening type
E32-T14F 	5-mm dia. 	H: 200 mm (3-mm dia.) A: 100 mm (3-mm dia.)	H: 0.9-mm dia. A: 0.7-mm dia.	Teflon covered* ² ; side-view; withstands chemicals and harsh environments
E32-T17L 	 M4 screw	H: 14,000 mm (10-mm dia. min.) A: 7,000 mm (10-mm dia. min.) F: 3,000 mm (10-mm dia. min.) V: 800 mm (10-mm dia. min.)	H: 2.1-mm dia. A: 0.8-mm dia. F: 1.5-mm dia. V: 2.1-mm dia.	Through-beam with lens, ideal for explosion-proof applications
E32-T12F 	5-mm dia. E32-T14F Teflon Side-view is also available. 	H: 1,600 mm (4-mm dia. min.) A: 800 mm (4-mm dia. min.) F: 300 mm (4-mm dia. min.) V: 70 mm (4-mm dia. min.)	H: 0.7-mm dia. A: 0.9-mm dia. F: 0.7-mm dia. V: 0.6-mm dia.	Teflon-covered* ³ ; withstands chemicals and harsh environments
E32-M21	 M3 screw	H: 300 mm (2-mm dia. min.) A: 150 mm (2-mm dia. min.) F: 65 mm (2-mm dia. min.) V: 20 mm (2-mm dia. min.)	H: 0.4-mm dia. A: 0.3-mm dia. F: 0.3-mm dia. V: 0.3-mm dia.	4-head; 4-point sensing
E32-T51 	M4 screw E32-T54 Heat-resisting Side-view is also available. 	H: 400 mm (1.5-mm dia. min.) A: 200 mm (1.5-mm dia. min.) F: 80 mm (1.5-mm dia. min.) V: 20 mm (1.5-mm dia. min.)	1.0-mm dia.	Heat-resistive; resists 150°C
E32-T54 	2-mm dia. 	H: 130 mm (1-mm dia. min.) A: 60 mm (1-mm dia. min.)	H: 0.3-mm dia. A: 0.2-mm dia.	Heat-resistive; side-view; resists 150°C
E32-T61	 M4 screw	H: 300 mm (3,000 mm* ²) (1.0-mm dia. min.) A: 150 mm (1,500 mm* ²) (1.0-mm dia. min.) F: 60 mm (450 mm) (1.0-mm dia. min.) V: 18 mm (130 mm* ²) (1.0-mm dia. min.)	H: 0.3-mm dia. A: 0.2-mm dia. F: 0.5-mm dia. V: 0.5-mm dia.	Heat-resistive; resists 300°C* ⁴

*1 An ambient operating temperature range between -40°C and 130°C will apply if the E32-T51 is used continuously.













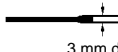



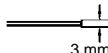

*2 Values in parentheses and an ambient operating temperature range between -40°C and 200°C will apply if the E39-F1 Lens Unit is used.

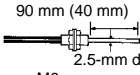
*3 Teflon is a registered trademark of the Dupont Company and the Mitsui Dupont Chemical Company for their fluoride resin.



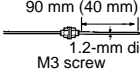







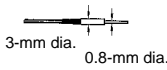





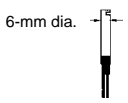

*4 The resistive temperature varies with the part of the Fiber Unit. For details, refer to *Dimensions*.

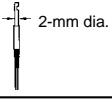
Reflective Sensors

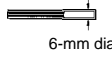
 Indicates models that allow free cutting. Models without this mark do not allow free cutting.

Model	Appearance	Sensing distance (H: E3X-H11; A: E3X-A□□; F: E3X-F□□; V: E3X-VG□□)			Min. sensing object (copper wire)	Features
		White paper	Black paper	Standard object		
E32-D11L 	 M6 screw	H: 200 mm A: 100 mm F: 45 mm V: 10 mm	H: 60 mm A: 30 mm F: 8 mm V: ---	H: 20 x 20 cm A: 10 x 10 cm F: 5 x 5 cm V: 2.5 x 2.5 cm	H: 0.015-mm dia. A: 0.015-mm dia. F: 0.2-mm dia. V: 3.0-mm dia.	Long distance
E32-D12 	 3 mm dia.	H: 120 mm A: 60 mm F: 15 mm V: 2 mm	H: 32 mm A: 16 mm F: 3 mm V: ---	H: 20 x 20 cm A: 10 x 10 cm F: 2.5 x 2.5 cm V: 2.5 x 2.5 cm	H: 0.015-mm dia. A: 0.04-mm dia. F: 2.4-mm dia. V: 1.6-mm dia.	Long distance
E32-D21L 	 M4 screw	H: 50 mm A: 25 mm F: 11 mm V: 1 mm	H: 14 mm A: 7 mm F: 2 mm V: ---	H: 5 x 5 cm A: 2.5 x 2.5 cm F: 2.5 x 2.5 cm V: 2.5 x 2.5 cm	H: 0.015-mm dia. A: 0.03-mm dia. F: 0.26-mm dia. V: 1.0-mm dia.	Long distance
E32-D22L 	 3 mm dia.	H: 50 mm A: 25 mm F: 11 mm V: 1 mm	H: 14 mm A: 7 mm F: 2 mm V: ---	H: 5 x 5 cm A: 2.5 x 2.5 cm F: 2.5 x 2.5 cm V: 2.5 x 2.5 cm	H: 0.015-mm dia. A: 0.03-mm dia. F: 0.26-mm dia. V: 1.0-mm dia.	Long distance
E32-DC200 	 M6 screw	H: 150 mm A: 75 mm F: 33 mm V: 10 mm	H: 30 mm A: 15 mm F: 5 mm V: ---	H: 20 x 20 cm A: 10 x 10 cm F: 5 x 5 cm V: 2.5 x 2.5 cm	H: 0.015-mm dia. A: 0.015-mm dia. F: 0.015-mm dia. V: 0.2-mm dia.	General-purpose
E32-DC200B E32-DC200B4 	 90 mm (40 mm) 2.5-mm dia. M6 screw Figures in parentheses are for the B4 model.	H: 150 mm A: 75 mm F: 33 mm V: 10 mm	H: 30 mm A: 15 mm F: 5 mm V: ---	H: 20 x 20 cm A: 10 x 10 cm F: 5 x 5 cm V: 2.5 x 2.5 cm	H: 0.015-mm dia. A: 0.03-mm dia. F: 0.03-mm dia. V: 1.0-mm dia.	General-purpose
E32-DC200E 	 M3 screw	H: 36 mm A: 18 mm F: 8 mm V: 2 mm	H: 7.2 mm A: 3.6 mm F: 1.5 mm V: ---	H: 5 x 5 cm A: 2.5 x 2.5 cm F: 2.5 x 2.5 cm V: 2.5 x 2.5 cm	H: 0.015-mm dia. A: 0.03-mm dia. F: 0.03-mm dia. V: 1.0-mm dia.	General-purpose
E32-DC200F E32-DC200F4 	 90 mm (40 mm) 1.2-mm dia. M3 screw Figures in parentheses are for the F4 model.	H: 36 mm A: 18 mm F: 8 mm V: 2 mm	H: 7.2 mm A: 3.6 mm F: 1.5 mm V: ---	H: 5 x 5 cm A: 2.5 x 2.5 cm F: 2.5 x 2.5 cm V: 2.5 x 2.5 cm	H: 0.015-mm dia. A: 0.03-mm dia. F: 0.03-mm dia. V: 1.0-mm dia.	General-purpose
E32-D11 	 M6 screw	H: 90 mm A: 45 mm F: 20 mm V: 7 mm	H: 20 mm A: 10 mm F: 5 mm V: ---	H: 10 x 10 cm A: 5 x 5 cm F: 2.5 x 2.5 cm V: 2.5 x 2.5 cm	H: 0.015-mm dia. A: 0.03-mm dia. F: 0.03-mm dia. V: 0.5-mm dia.	Flexible (resists breaking)
E32-D21 	 M3 screw	H: 14 mm A: 7 mm F: 3 mm V: 1 mm	H: 3 mm A: 1.5 mm F: --- V: ---	2.5 x 2.5 cm	H: 0.015-mm dia. A: 0.03-mm dia. F: 0.03-mm dia. V: 1.0-mm dia.	Flexible (resists breaking)

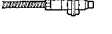
 Indicates models that allow free cutting. Models without this mark do not allow free cutting.

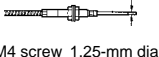
Model	Appearance	Sensing distance (H: E3X-H11; A: E3X-A□□; F: E3X-F□□; V: E3X-VG□□)			Min. sensing object (copper wire)	Features
		White paper	Black paper	Standard object		
E32-D33 	 3-mm dia. 0.8-mm dia.	H: 10 mm A: 5 mm F: 1.8 mm V: ---	H: 2 mm A: --- F: --- V: ---	2.5 x 2.5 cm	H: 0.015-mm dia. A: 0.015-mm dia. F: 0.03-mm dia. V: ---	Super-thin; detail sensing
E32-CC200 	 M6 screw	H: 150 mm A: 75 mm F: 33 mm V: 10 mm	H: 30 mm A: 15 mm F: 6 mm V: 2 mm	H: 20 x 20 cm A: 10 x 10 cm F: 5 x 5 cm V: 2.5 x 2.5 cm	H: 0.015-mm dia. A: 0.03-mm dia. F: 0.03-mm dia. V: 0.5-mm dia.	Coaxial; positioning accuracy
E32-D32 	 2-mm dia.	H: 40 mm A: 20 mm F: 9 mm V: 2.5 mm	H: 8 mm A: 4 mm F: 1.5 mm V: ---	H: 5 x 5 cm A: 2.5 x 2.5 cm F: 2.5 x 2.5 cm V: 2.5 x 2.5 cm	H: 0.015-mm dia. A: 0.03-mm dia. F: 0.03-mm dia. V: 0.5-mm dia.	Coaxial; positioning accuracy
E32-D32L 	 3-mm dia.	H: 80 mm A: 40 mm F: 11 mm V: 4 mm	H: 16 mm A: 8 mm F: 4 mm V: ---	H: 10 x 10 cm A: 5 x 5 cm F: 2.5 x 2.5 cm V: 2.5 x 2.5 cm	H: 0.015-mm dia. A: 0.04-mm dia. F: 1.1-mm dia. V: 1-mm dia.	Coaxial; positioning accuracy
E32-D14L 	 6-mm dia.	H: 40 mm A: 40 mm F: 12 mm V: 1.5 mm	H: 8 mm A: 8 mm F: 2 mm V: ---	H: 5 x 5 cm A: 5 x 5 cm F: 2.5 x 2.5 cm V: 2.5 x 2.5 cm	H: 0.03-mm dia. A: 0.03-mm dia. F: 0.5-mm dia. V: 1.0-mm dia.	Side-view; long distance
E32-D24 	 2-mm dia.	H: 15 mm A: 15 mm F: 4 mm V: 1.6 mm	H: 2.5 mm A: 2.5 mm F: --- V: ---	2.5 x 2.5 cm	H: 0.03-mm dia. A: 0.03-mm dia. F: 0.03-mm dia. V: 1.0-mm dia.	Side-view; save space
E32-D12F 	 6-mm dia.	H: 50 mm A: 50 mm F: 20 mm V: 4 mm	H: 15 mm A: 15 mm F: 6 mm V: ---	H: 5 x 5 cm A: 5 x 5 cm F: 2.5 x 2.5 cm V: 2.5 x 2.5 cm	H: 0.03-mm dia. A: 0.03-mm dia. F: 0.5-mm dia. V: 0.5-mm dia.	Teflon-covered* ¹ ; withstands chemi- cals and harsh en- vironments
E32-D51 	 M6 screw	H: 120 mm A: 60 mm F: 26 mm V: 5 mm	H: 24 mm A: 12 mm F: 5 mm V: ---	H: 20 x 20 cm A: 10 x 10 cm F: 5 x 5 cm V: 2.5 x 2.5 cm	H: 0.03 mm dia. A: 0.03-mm dia. F: 0.03-mm dia. V: 1.0-mm dia.	Heat-resistive; resists 150°C* ²
E32-D61 	 M6 screw	H: 45 mm A: 45 mm F: 20 mm V: 5 mm	H: 9 mm A: 9 mm F: 4 mm V: ---	H: 5 x 5 cm A: 5 x 5 cm F: 2.5 x 2.5 cm V: 2.5 x 2.5 cm	H: 0.03-mm dia. A: 0.03-mm dia. F: 0.03-mm dia. V: 1.0-mm dia.	Heat-resistive; resists 300°C* ³
E32-D73 	 M4 screw 1.25-mm dia.	H: 30 mm A: 30 mm F: 17 mm V: 3 mm	H: 6 mm A: 6 mm F: 3 mm V: ---	H: 5 x 5 cm A: 5 x 5 cm F: 2.5 x 2.5 cm V: 2.5 x 2.5 cm	H: 0.03-mm dia. A: 0.03-mm dia. F: 0.2-mm dia. V: 1.0-mm dia.	Heat-resistive; resists 400°C* ³







Note: Setting the sensitivity adjuster to its maximum level may cause a change to the light reception state. In such a case, lower the sensitivity adjuster level.

*1 Teflon is a registered trademark of the Dupont Company and the Mitsui Dupont Chemical Company for their fluoride resin.

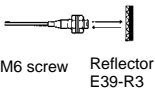
*2 An ambient temperature range between -40°C and 130°C will apply if the Sensor is used continuously.

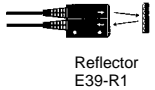
*3 The resistive temperature varies with the part of the Fiber Unit. For details, refer to *Dimensions*.

 Indicates models that allow free cutting. Models without this mark do not allow free cutting.





Model	Appearance	Sensing distance (H: E3X-H11; A: E3X-A□□; F: E3X-F□□)			Min. sensing object (copper wire)	Features
		White paper	Black paper	Standard object		
E32-R21 /E39-R3* ¹ 	 M6 screw Reflector E39-R3	H: 10 to 250 mm A: 10 to 250 mm F: 20 to 230 mm	---	35-mm dia. min.* ²	H: 0.3-mm dia. A: 0.3-mm dia. F: 0.5-mm dia.	Retroreflective models (with MSR function)* ⁴
E32-R16 /E39-R1* ¹ 	 Reflector E39-R1	H: 150 to 1,500 mm A: 150 to 1,500 mm F: 50 to 700 mm	---	35-mm dia. min.* ²	0.6-mm dia.	Transparent objects sensing
E32-L25* ³ 		3.3 mm	---	2.5 x 2.5 cm	H: 0.015-mm dia. A: 0.03-mm dia. F: 0.5-mm dia.	Limited reflective; senses wafers and small difference in height
E32-L25A * ³ 		3.3 mm	---	2.5 x 2.5 cm	H: 0.015-mm dia. A: 0.03-mm dia. F: 0.5-mm dia.	Limited reflective; senses wafers and small difference in height

*¹ The ambient temperature of the attached Reflector is the same as the one for E32-R21 and E32-R16.

*² Standard object: opaque

*³ For standard sensing distances, refer to *Dimensions*.

*⁴ MSR function (Mirror Face Rejection) ensures stable sensing for objects with glossy surfaces.



Model	Appearance	Sensing distance (H: E3X-H11; A: E3X-A□□; F: E3X-F□□)			Min. sensing object (copper wire)	Features
		White paper	Black paper	Standard object		
E32-L25L* ^{1, 2} 		H: 7.2±1.8 mm A: 7.2±1.8 mm F: 7.2±1.0 mm	---	2.5 x 2.5 cm* ¹	0.015-mm dia.	Limited reflective, long distance; senses wafers and small difference in height
E32-L24L* ^{1, 2} 		H: 4±2 mm A: 4±2 mm F: 4±2 mm	---	H: 2.5 x 2.5 cm A: 2.5 x 2.5 cm F: 2.5 x 2.5 cm	0.015-mm dia.	Limited reflective, long distance, side-view; senses wafers and small difference in height

*¹ For standard sensing distances, refer to *Dimensions*.

*² An ambient temperature range between -40°C and 90°C will apply if the Sensor is used continuously.

Slot Sensors

 Indicates models that allow free cutting. Models without this mark do not allow free cutting.

Model	Appearance	Sensing distance (standard object: opaque)	Min. sensing object (opaque objects)	Features
E32-G14 		10 mm (slot width) (4-mm dia. min.)	H: 1.0-mm dia. A: 0.5-mm dia. F: 0.6-mm dia. V: 0.6-mm dia.	Groove; no optical axis adjustment required

Liquid Level Fiber Unit

Liquid Contact Model

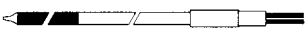
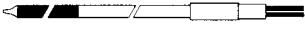
Model	Appearance	Standard sensing object	Sensing object angle range	Repeat frequency	Applicable Amplifier Unit
E32-D82F1	 Diffuse reflective	Pure water at a temperature of 25°C.	±10° max.	0.5 mm max.	E3X-NT/NM* E3X-NV E3X-H
E32-D82F2					





Note: *When using the E32-D82F1 or E82-D82F2 with the E3X-A, cut the plastic fiber part to 0.5 m, otherwise the energy of the light received by the E3X-A will be insufficient.

Pipe Mounting Model

Model	Appearance	Standard sensing object	Repeat frequency	Applicable Amplifier Unit
E32-L25T		Liquid (Opaque liquids may not be sensed)	1 mm max.	E3X-NT/NM E3X-A/H

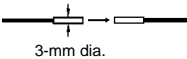
Note: Also available is a Photomicrosensor for sensing liquid levels. Refer to the *EE-SPX311/411 Datasheet (Cat. No. E245-E1)*.

Fine Through-beam

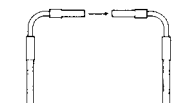
Model	Appearance	Sensing distance (standard object: opaque)	Min. sensing object (opaque objects)	Features
E32-T22S 	 3-mm dia.	H: 1,000 mm (1.7-mm dia. min.)* ¹	H: 0.5-mm dia.	General purpose, sensing the wafers in cassettes (Fine, long beam sensor)
E32-T24S 	 3.5 x 3 mm dia.	H: 700 mm (2.0-mm dia. min.)* ¹	H: 0.5-mm dia.	Side-view, sensing the wafers in cassettes (Fine, long beam sensor)
E32-T84S 		H: 700 mm (1.7-mm dia. min.)	H: 0.4-mm dia.	Sensing the wafers in cassettes (Fine, long beam sensor resisting 200°C)* ²

*¹ Use the E32-T22S and E32-T24S in combination with the E3X-H11 Amplifier for stable wafer sensing.

*² The resistive temperature varies with the part of the Fiber Unit. For details, refer to *Dimensions*.

Sensitivity Adjustment

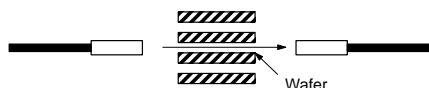

Combination with E3X-H11

1. Set the hysteresis adjuster to Min.
2. Adjust the sensitivity by turning the hysteresis adjuster clockwise with no wafers located in the sensing range until stable light reception is barely ensured and both light reception and stability indicators are ON.

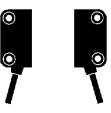

High-precision Screen Sensors

 Indicates models that allow free cutting. Models without this mark do not allow free cutting.

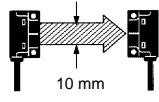
Model	Appearance	Slit width	Sensing distance (H: E3X-H11; A: E3X-A□□; F: E3X-F□□; V: E3X-VG□□)	Min. sensing object (horizontal beam)
E32-T16P 	Through-beam  (Visual field: 2 x 11 mm)	Not used	H: 600 mm A: 300 mm	H: 1.3-mm dia. (1.1-mm dia.) A: 2.0-mm dia. (0.9-mm dia.)
		0.5 mm wide	H: 100 mm A: 50 mm	H: 1.3-mm dia. (0.4-mm dia.) A: 2.0-mm dia. (0.7-mm dia.)
		1.0 mm wide	H: 200 mm A: 100 mm	H: 1.3-mm dia. (0.6-mm dia.) A: 2.0-mm dia. (0.8-mm dia.)
E32-T16 	Screen Through-beam  (Visual field: 2 x 10 mm)	Not used	H: 1,500 mm A: 750 mm F: 330 mm V: 150 mm	H: 6.0-mm dia. A: 6.0-mm dia. F: 7.0-mm dia. V: 7.0 mm dia.
		0.5 mm wide	H: 900 mm A: 450 mm F: 120 mm V: 20 mm	H: 5.0-mm dia. A: 5.0-mm dia. F: 7.0-mm dia. V: 7.0-mm dia.
		1.0 mm wide	H: 1,200 mm A: 600 mm F: 250 mm V: 60 mm	H: 6.0-mm dia. A: 6.0-mm dia. F: 7.0-mm dia. V: 7.0-mm dia.

Note: Values not in parentheses represent sensing objects within the 11-mm sensing area and values in parentheses represent sensing objects in the center of the E32-T16P sensing area. The diameters of sensing objects in the above table represent sensing object sizes, on condition that the objects are not moving.

Sensing Method

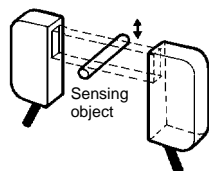

Specifications

Amplifier Units

Indicator	Light indicator (red), Stability indicator (green)
Sensitivity adjuster	8 turns with indicator
Circuit protection	Reverse polarity, Output short-circuit
Ambient illumination	Sunlight: 10,000 lx max.; Incandescent lamp: 3,000 lx max.
Ambient temperature	Operating: -25°C to 55°C (with no icing) Storage: -40°C to 70°C
Ambient humidity	35% to 85% (with no condensation)
Insulation resistance	20 MΩ min. (at 500 VDC)
Dielectric strength	1,000 VAC, 50/60 Hz for 1 min
Degree of protection	IEC60529 IP66 (with Protective Cover in place) (see note)
Material	Case: Heat-resistant ABS; Cover: Polycarbonate
Weight (with 2-m cord)	Approx. 100 g

Note: The degree of protection is IP65 if the Fiber Unit connected is a fine-beam model, high-temperature model (E32-T61, E32-D61, E32-D73), direct sleeve model, or the E32-M21. The degree of protection is IP50 without the Protective Cover.

Fiber Unit

Through-beam (Separate) Sensors

Model	Ambient temperature	Ambient humidity	Permissible bending radius	Material	Degree of protection
E32-T11L	Operating: -40°C to 70°C (with no icing)	Operating: 35% to 85%	25 mm min.	Black polyethylene	IEC60529 IP67
E32-T12L					
E32-T21L					
E32-T22L					
E32-TC200					
E32-TC200B					
E32-TC200B4					
E32-T22					
E32-TC200E					
E32-TC200F					
E32-TC200F4					
E32-TC200A					
E32-T11					
E32-T21					
E32-T14L	Operating: -30°C to 70°C (with no icing)	Operating: 35% to 85%	4 mm min.	Vinyl chloride	IEC60529 IP67
E32-T24					
E32-T14					
E32-T17L					
E32-T12F					
E32-T14F					
E32-M21					
E32-T51					
E32-T54					
E32-T61					
E32-T54			Operating: -40°C to 150°C* ¹ (with no icing)	Operating: 35% to 85%	
E32-T54					
E32-T61	Operating: -40°C to 300°C* ² (with no icing)	Operating: 35% to 85%	40 mm min.	Teflon-covered black polyethylene	IEC60529 IP67
E32-T61					
E32-T61	Operating: -40°C to 300°C* ² (with no icing)	Operating: 35% to 85%	25 mm min.	Black polyethylene	IEC60529 IP67
E32-T61					
E32-T61	Operating: -40°C to 300°C* ² (with no icing)	Operating: 35% to 85%	35 mm min.	Fluoride resin	IEC60529 IP67
E32-T61					
E32-T61	Operating: -40°C to 300°C* ² (with no icing)	Operating: 35% to 85%	25 mm min.	SUS	IEC60529 IP67
E32-T61					

*¹ When used continuously between -40°C and 130°C.

*² The resistive temperature varies with the part of the Fiber Unit. For details, refer to *Dimensions*.

Reflective Sensors

Model	Differential travel	Ambient temperature	Ambient humidity	Permissible bending radius	Material	Degree of protection				
E32-D11L	20% of max. of sensing distance (Adjustable in a range of 0% to 20% when the E3X-H11 is used.)	Operating: -40°C to 70°C (with no icing)	Operating: 35% to 85%	25 mm min.	Black polyethylene	IEC60529 IP67				
E32-D12										
E32-D21L										
E32-D22L										
E32-DC200										
E32-DC200B										
E32-DC200B4										
E32-DC200E										
E32-DC200F										
E32-DC200F4										
E32-D11										
E32-D21										
E32-D33										
E32-CC200										
E32-D32										
E32-D32L										
E32-D14L										
E32-D24										
E32-D12F	Max. of 5% of the sensing distance	Operating: -30°C to 70°C (with no icing)	40 mm min.	40 mm min.	Teflon-covered black polyethylene	IEC60529 IP66				
E32-D51										
E32-D61										
E32-D73										
E32-R21/ E39-R3										
E32-R16/ E39-R1										
E32-L25*4										
E32-L25A*4										
E32-L25L*4										
E32-L24L*4										
E32-D11		Max. of 5% of the sensing distance			Operating: -40°C to 70°C (with no icing)		Operating: 35% to 85%	4 mm min.	Vinyl chloride	IEC60529 IP50
E32-D21										
E32-D33										
E32-CC200										
E32-D32										
E32-D32L										
E32-D14L										
E32-D24										
E32-D12F										
E32-D51										
E32-D61										
E32-D73										
E32-R21/ E39-R3										
E32-R16/ E39-R1										
E32-L25*4										
E32-L25A*4										
E32-L25L*4										
E32-L24L*4										
E32-D11	Max. of 5% of the sensing distance	Operating: -40°C to 70°C (with no icing)	Operating: 35% to 85%	35 mm min.	Fluoride resin	IEC60529 IP66				
E32-D21										
E32-D33										
E32-CC200										
E32-D32										
E32-D32L										
E32-D14L										
E32-D24										
E32-D12F										
E32-D51										
E32-D61										
E32-D73										
E32-R21/ E39-R3										
E32-R16/ E39-R1										
E32-L25*4										
E32-L25A*4										
E32-L25L*4										
E32-L24L*4										
E32-D11	Max. of 5% of the sensing distance	Operating: -40°C to 70°C (with no icing)	Operating: 35% to 85%	25 mm min.	SUS	IEC60529 IP66				
E32-D21										
E32-D33										
E32-CC200										
E32-D32										
E32-D32L										
E32-D14L										
E32-D24										
E32-D12F										
E32-D51										
E32-D61										
E32-D73										
E32-R21/ E39-R3										
E32-R16/ E39-R1										
E32-L25*4										
E32-L25A*4										
E32-L25L*4										
E32-L24L*4										
E32-D11	Max. of 5% of the sensing distance	Operating: -40°C to 70°C (with no icing)	Operating: 35% to 85%	10 mm min. (average at 10% decrease of sensing distance)	Reinforced polyethylene	IEC60529 IP50				
E32-D21										
E32-D33										
E32-CC200										
E32-D32										
E32-D32L										
E32-D14L										
E32-D24										
E32-D12F										
E32-D51										
E32-D61										
E32-D73										
E32-R21/ E39-R3										
E32-R16/ E39-R1										
E32-L25*4										
E32-L25A*4										
E32-L25L*4										
E32-L24L*4										

*1 When used continuously between -40°C and 130°C.

*2 The resistive temperature varies with the part of the Fiber Unit. For details, refer to *Dimensions*.

*3 An ambient temperature range between -40°C and 90°C will apply if the Sensor is used continuously.

*4 Beam size: 2-mm dia.

Slot Sensors

Model	Ambient temperature	Ambient humidity	Permissible bending radius	Material	Degree of protection
E32-G14	Operating: -40°C to 70°C (with no icing)	Operating: 35% to 85%	25 mm min.	Black polyethylene	IEC60529 IP67

Liquid Contact Model

Model	Differential travel	Ambient temperature	Ambient humidity	Ambient pressure	Permissible bending radius (10% decrease of sensing distance)	Material	Degree of protection
E32-D82F1	3.0 mm max.	Teflon part within 1.5 m of fiber tip* ¹ : -40°C to 200°C (with no icing) Parts other than above: -40°C to 85°C (with no icing)	Operating: 35% to 85%	-50 kpa (-0.49 kgf/cm ²) to 500 kpa (4.9 kgf/cm ²)	40 mm min. (plastic fiber: 25 mm min.) Bending-prohibited part: E32-D82F1: Within 150 mm of fiber tip E32-D82F2: Within 350 mm of fiber tip	Sensing head: Teflon* ¹ (PFA) Fiber sheath: Black polyethylene Connector: Nickel-coated brass	IEC60529 IP68* ²
E32-D82F2							

*1 Teflon is a registered trademark of the Dupont Company and the Mitsui Dupont Chemical Company for their fluoride resin.

*2 The Teflon part located 10 cm underwater must not generate air bubbles when air is injected into the Teflon part for 30 seconds with a pressure of 98 kpa (1 kgf/cm²).

Pipe Mounting Model

Model	Suitable pipe	Pipe material	Ambient temperature	Ambient humidity	Permissible bending radius	Material	Degree of protection	Fiber length
E32-L25T	Transparent pipes with an outer diameter of 8 to 10 mm and thickness of 1 mm	FEP transparent pipes or equivalent	Operating: -40°C to 70°C (with no icing)	Operating: 35% to 85%	10 mm min.	Sensing head: Poly-carbonate Fiber: Polyethylene-covered plastic	IEC60529 IP50	2 m (free cut)

Fine Through-beam Sensors



Model	Beam size	Differential travel	Horizontal positioning accuracy	Ambient temperature	Ambient humidity	Permissible bending radius*	Material	Degree of protection
E32-T22S	13 mm dia. (at a distance of 200 mm)	---	---	Operating: -40°C to 70°C (with no icing)	Operating: 35% to 85%	10 mm min.	Reinforced laminated vinyl chloride	IEC60529 IP67
E32-T24S								
E32-T84S				Operating: -40°C to 200°C (with no icing)		25 mm min.	SUS	

*Average at 10% decrease of sensing distance.

High-precision Screen Sensors

Model	Ambient temperature	Ambient humidity	Permissible bending radius	Material	Degree of protection
E32-T16P	Operating: -40°C to 70°C (with no icing)	Operating: 35% to 85%	R10 mm min.	Sensing head: Heat-resistive ABS Fiber sheath: Vinyl chloride	IEC60529 IP50
E32-T16			25 mm min.	Sensing head: Heat-resistive ABS Sensing surface: PMMA Fiber sheath: Black polyethylene	

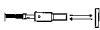

Attachments

Name		Small Spot Lens Unit	Long Distance Lens Unit		
Applications		0.5-mm-dia. beam spot	Increasing sensing distance		
Model		E39-F3A	E39-F1		
Appearance		Reflective 	Through-beam (separate) 		
Applicable fibers		E32-D32	E32-T11L	E32-TC200 E32-T61	E32-T11
With E3X-H11	Sensing distance	20 mm	2,000 mm	3,000 mm	2,000 mm
	Standard object	White paper 2.5 x 2.5 cm	Opaque objects: 4-mm dia. min.		
With E3X-A□□	Sensing distance	20 mm	1,000 mm	1,500 mm	1,000 mm
	Standard object	White paper 2.5 x 2.5 cm	Opaque objects: 4-mm dia. min.		
With E3X-F□□	Sensing distance	16 mm	550 mm	670 mm* ¹	400 mm
	Standard object	White paper 2.5 x 2.5 cm	Opaque objects: 4-mm dia. min.		
With E3X-VG□□	Sensing distance	---	120 mm	190 mm* ²	120 mm
	Standard object	---	Opaque objects: 4-mm dia. min.		
Directional angle		---	5° to 40°		
Differential travel		20% max. of sensing distance	---		
Ambient temperature		Operating: -40°C to 70°C	Operating: -40°C to 200°C (with no icing)* ³		
Material	Shaft	Aluminum	Brass		
	Lens	Optical glass			
	Base	---			
	Reflector	---			

Name		Side-view Unit		
Applications		Changing the sensing direction to side view		
Model		E39-F2		
Appearance		Through-beam (separate) 		
Applicable fibers		E32-T11L	E32-TC200	E32-T61/11
With E3X-H11	Sensing distance	400 mm	500 mm	400 mm
	Standard object	Opaque objects: 3-mm dia. min.		
With E3X-A□□	Sensing distance	200 mm	250 mm	200 mm
	Standard object	Opaque objects: 3-mm dia. min.		
With E3X-F□□	Sensing distance	60 mm	100 mm	60 mm
	Standard object	Opaque objects: 3-mm dia. min.		
With E3X-VG□□	Sensing distance	10 mm	19 mm	10 mm
	Standard object	Opaque objects: 4-mm dia. min.	Opaque objects: 3-mm dia. min.	
Directional angle		20° to 60°		
Differential travel		---		
Ambient temperature		Operating: -40°C to 200°C (with no icing)* ³		
Material	Shaft	Brass		
	Lens	Optical glass		
	Base	---		
	Reflector	---		

*¹ E32-T61: 450 mm.*² E32-T61: 130 mm.*³ Be sure to use within the temperature range specified for the Fiber to be used. When using in combination with the E32-T61, the Unit must be used within the temperature range of -40°C and 200°C.

Name			Lens-equipped Reflective Unit		
Applications			Converting through-beam sensors to reflective sensors		
Model			E39-F3		
Appearance			 Reflective		
Applicable fibers			E32-T11L	E32-TC200	E32-T61
With E3X-H11	Sensing distance (standard object)	White paper	10 to 300 mm (20 x 20 cm)	35 to 180 mm (20 x 20 cm)	
		Black paper	---	5 to 120 mm (20 x 20 cm)	5 to 80 mm (20 x 20 cm)
With E3X-A□□	Sensing distance (standard object)	White paper	10 to 150 mm (20 x 20 cm)	35 to 90 mm (10 x 10 cm)	
		Black paper	---	5 to 60 mm (10 x 10 cm)	5 to 40 mm (10 x 10 cm)
With E3X-F□□	Sensing distance (standard object)	White paper	10 to 65 mm (10 x 10 cm)	20 to 40 mm (5 x 5 cm)	20 to 35 mm (5 x 5 cm)
		Black paper	---	10 to 20 mm (5 x 5 cm)	---
With E3X-VG□□	Sensing distance (standard object)	White paper	---	10 to 15 mm (2.5 x 2.5 cm)	---
		Black paper	---	---	---
Directional angle			---		
Differential travel			20% max. of sensing distance		
Ambient temperature			Operating: -40°C to 200°C (Do not exceed the operating temperature of the fiber.)		
Material	Shaft	Brass			
	Lens	Optical glass			
	Base	Aluminum			
	Reflector	---			

Name			Lens-equipped Reflective Unit	Side-view Reflective Unit
Applications			Converting through-beam sensors to reflective sensors	Converting through-beam to reflective sensor
Model			E39-F3	E39-F5
Appearance			 Reflective	 Reflective
Applicable fibers			E32-T11	E32-TC200A
With E3X-H11	Sensing distance (standard object)	White paper	35 to 180 mm (20 x 20 cm)	60 mm (10 x 10 cm)
		Black paper	5 to 70 mm (20 x 20 cm)	5 to 20 mm (10 x 10 cm)
With E3X-A□□	Sensing distance (standard object)	White paper	35 to 90 mm (10 x 10 cm)	30 mm (5 x 5 cm)
		Black paper	5 to 35 mm (10 x 10 cm)	5 to 10 mm (5 x 5 cm)
With E3X-F□□	Sensing distance (standard object)	White paper	20 to 40 mm (5 x 5 cm)	13 mm (2.5 x 2.5 cm)
		Black paper	---	---
With E3X-VG□□	Sensing distance (standard object)	White paper	---	---
		Black paper	---	---
Directional angle			---	
Differential travel			20% max. of sensing distance	
Ambient temperature			Operating: -40°C to 200°C (Do not exceed the operating temperature of the fiber.)	Operating: -40°C to 70°C
Material	Shaft	Brass		---
	Lens	Optical glass		---
	Base	Aluminum		Brass
	Reflector	---		Stainless

Beam Spot Characteristics E39-F3A

*Common to the E3X-N and E3X Series.

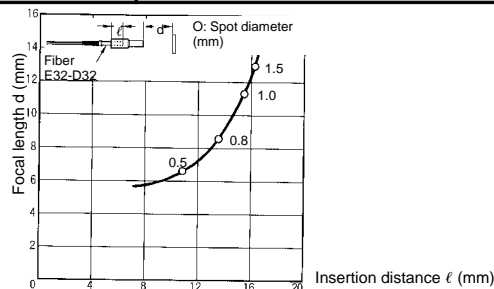

Engineering Data

■ Excess Gain Ratio vs. Distance (Typical)

Sensing Object: Standard Sensing Object

E3X-H11

E32-TC200

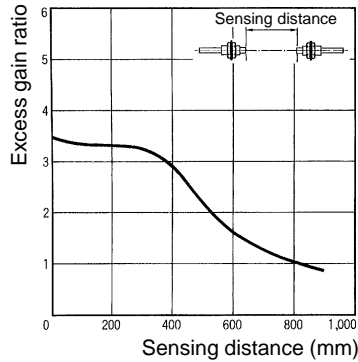

E32-TC200 + E39-F1

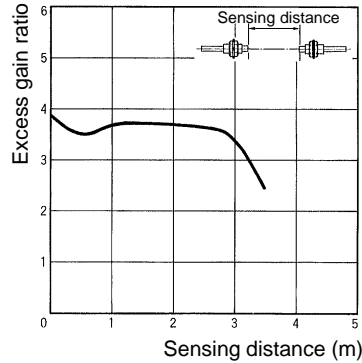

E32-T11L

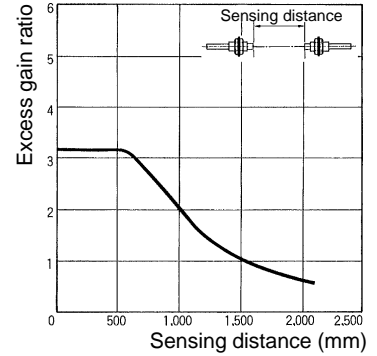

E32-T11L + E39-F1

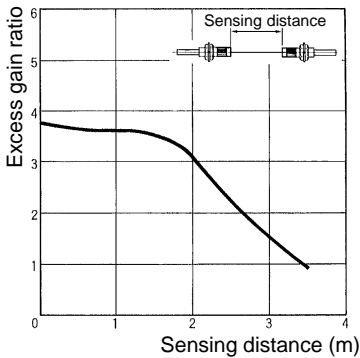

E32-T11L + E39-F2

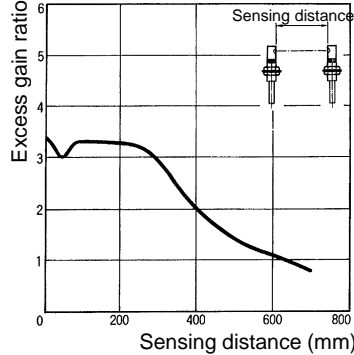

E32-T11L + E39-F3

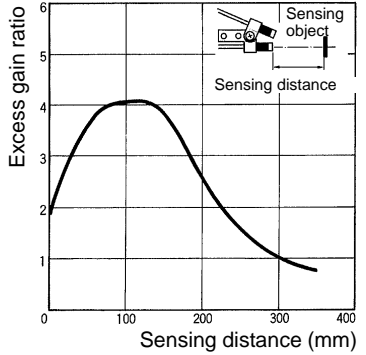

E32-T21L

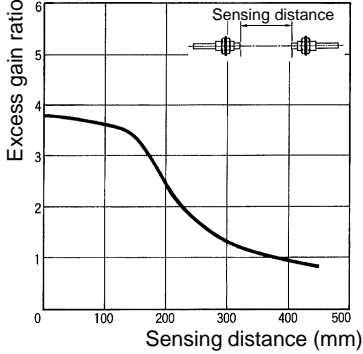

E32-T14L

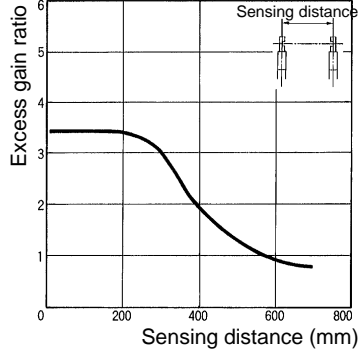

E32-T17L

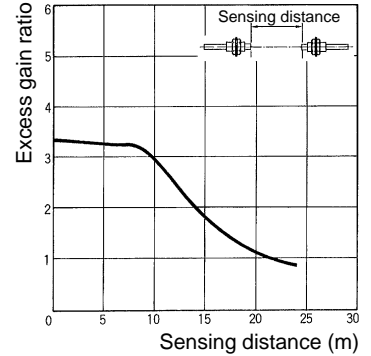

E32-T16

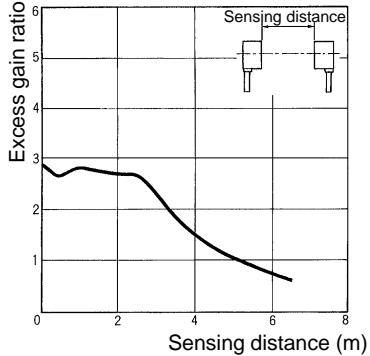

E32-T22S

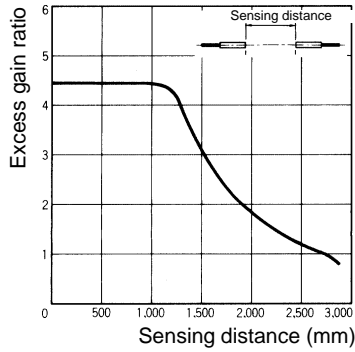

E32-T24S

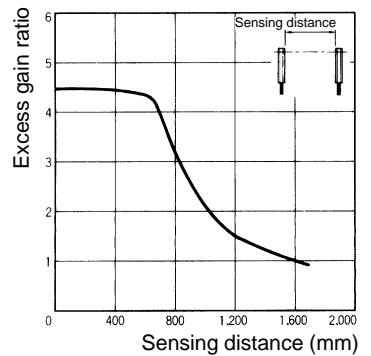

E32-DC200

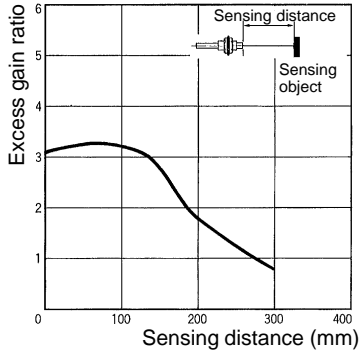

E32-D11L

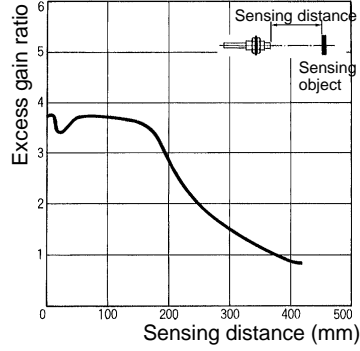

E32-D21L

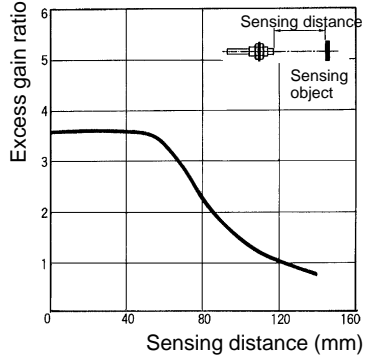

E32-T84S

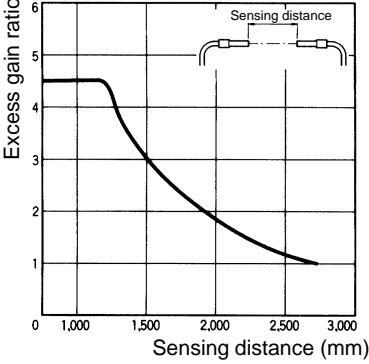

E32-T54

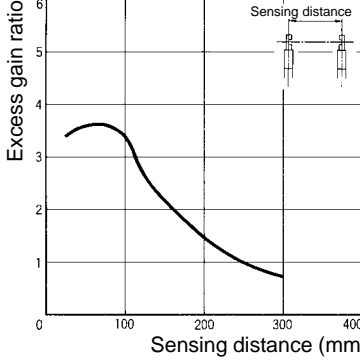

E32-T14F

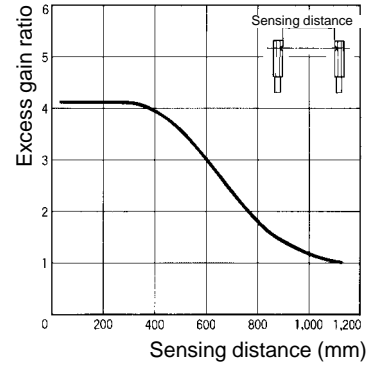

E3X-A□□/-F□□/-VG□□

E32-T11L, E32-T12L

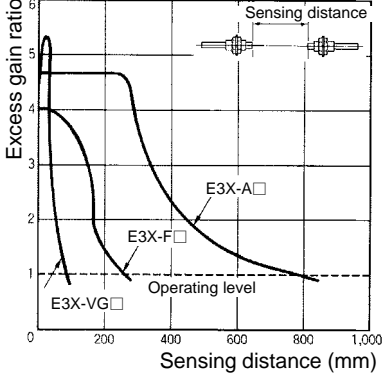

E32-T11L + E39-F1

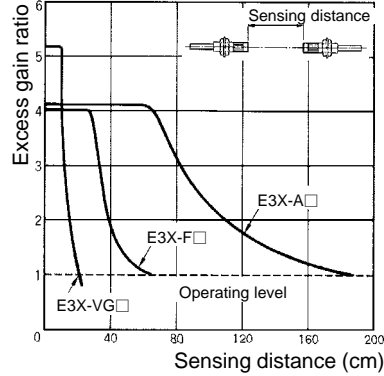

E32-T11L + E39-F2

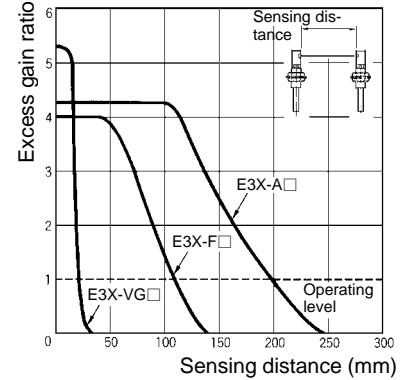

E32-T11L + E39-F3

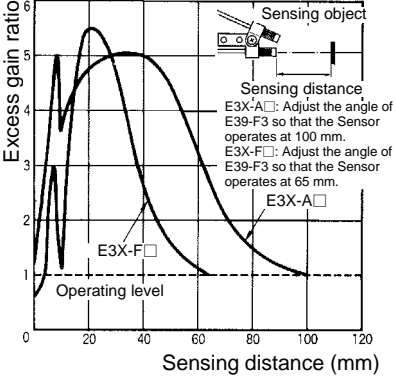

E32-T21L, E32-T22L

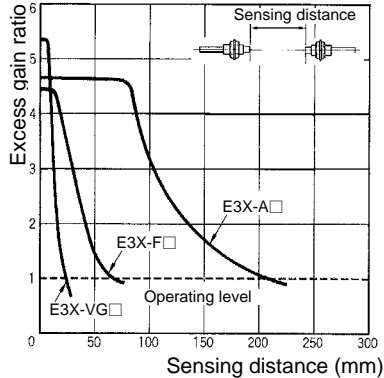

E32-T14L

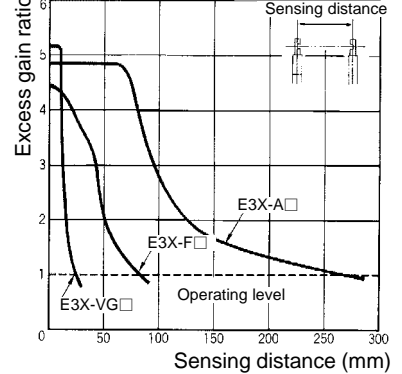

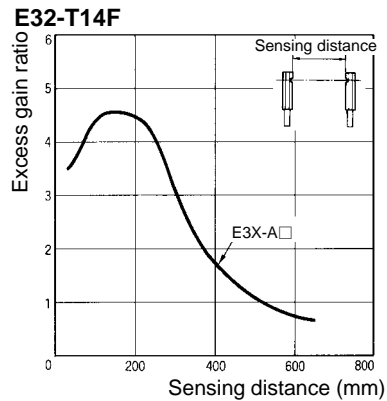
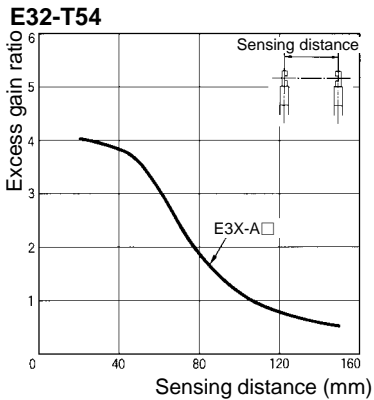
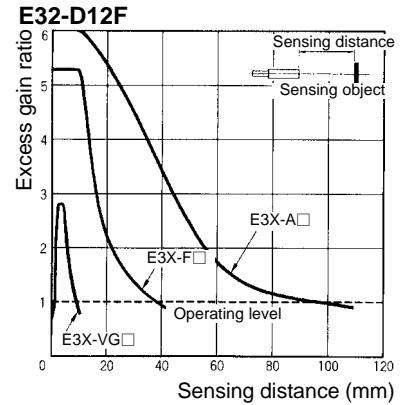
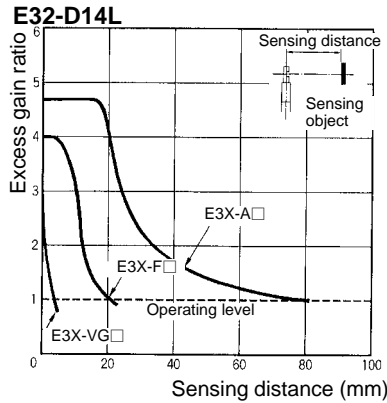
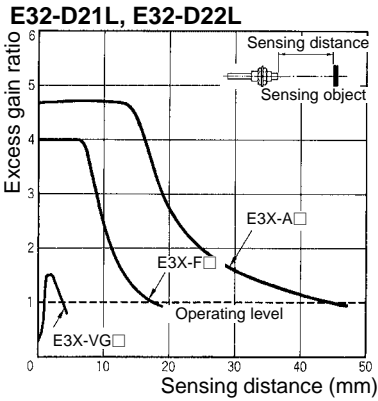
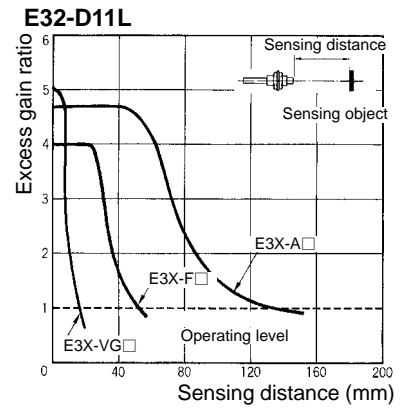
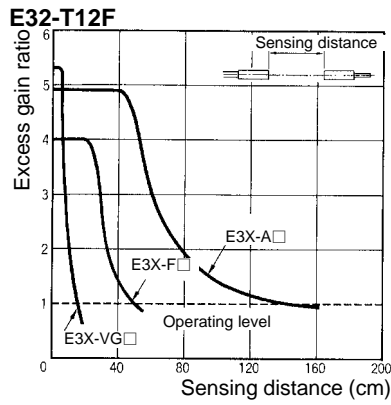
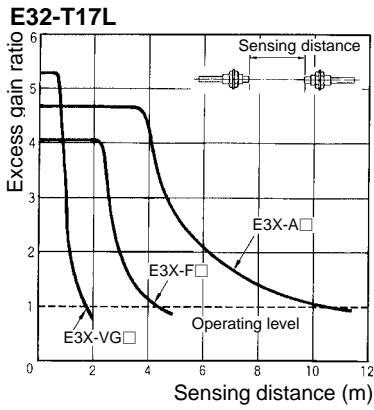

■ **Operating Ranges (Typical)**

Sensing Object: Standard Sensing Object; Sensitivity Level: Maximum

E3X-H11

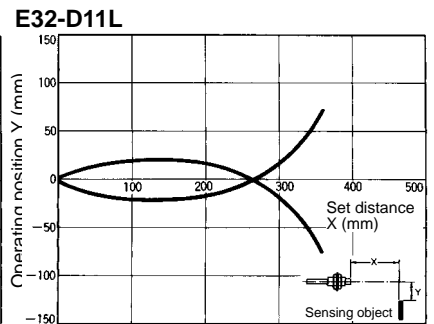
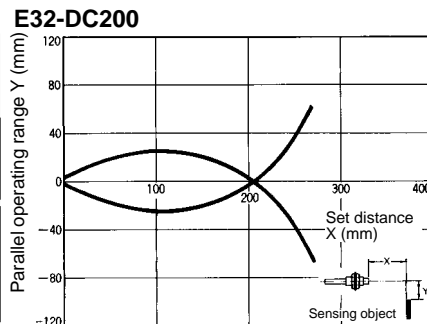
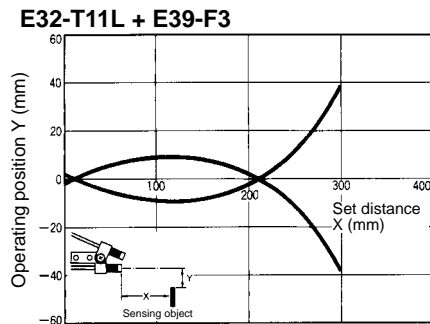

E32-D12

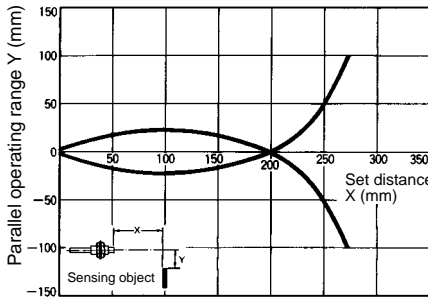

E32-D21L

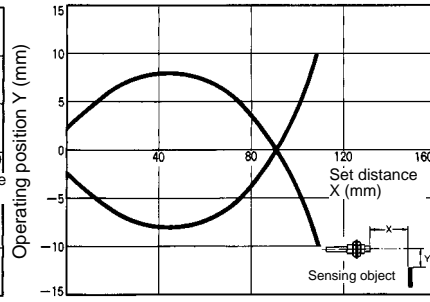

E32-DC200E

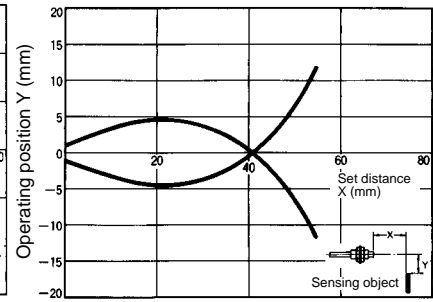

E32-D21

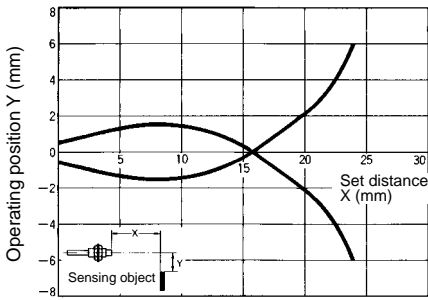

E32-D11

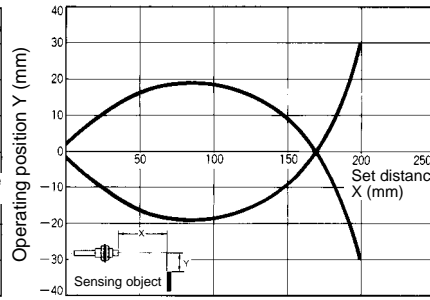

E32-CC200

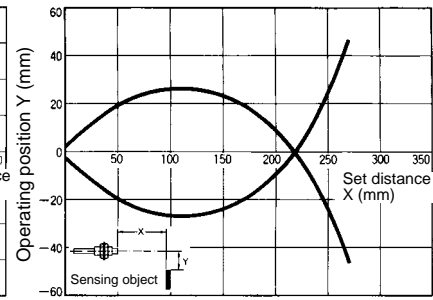

E32-D32

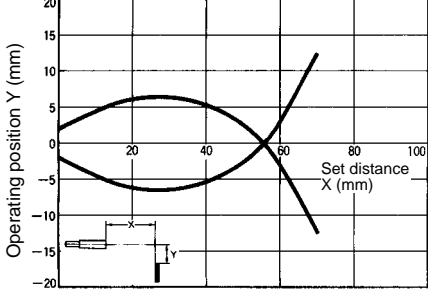

E32-D32L

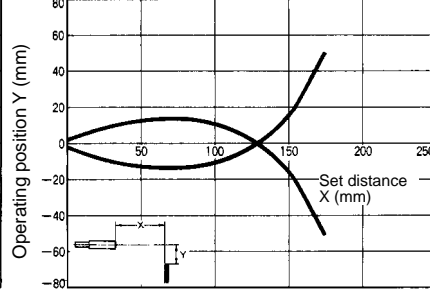

E32-D33

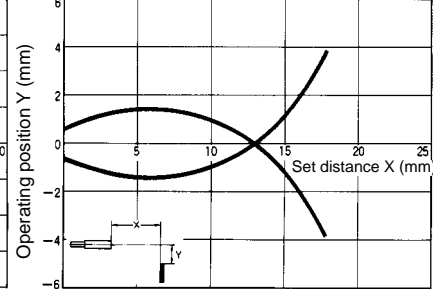

E32-D51

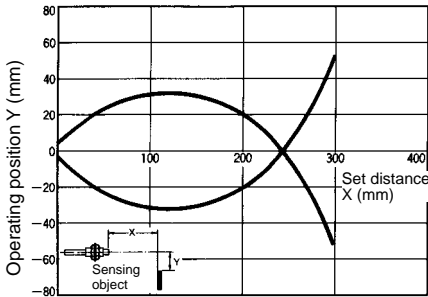

E32-L25L

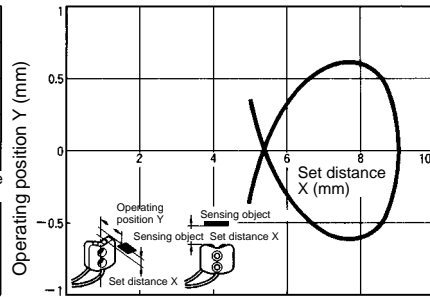

E32-T84S

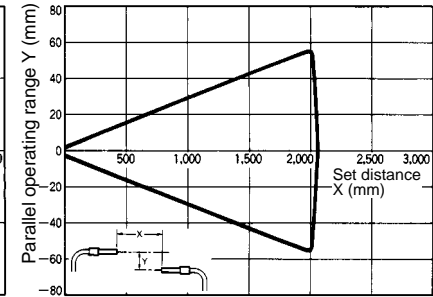

E3X-A□□/-F□□/-VG□□

E32-T11L + E39-F3

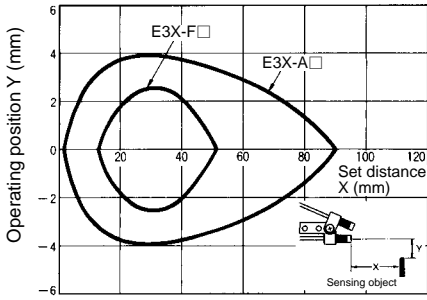

E32-DC200

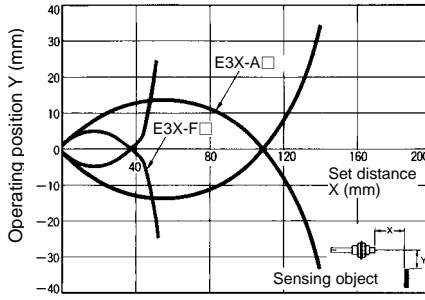

E32-D11L

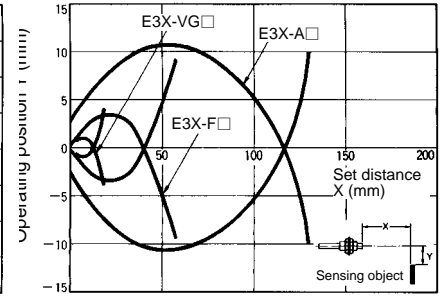

E32-D12

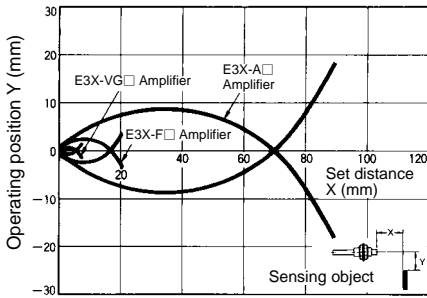

E32-D21L + E32-D22L

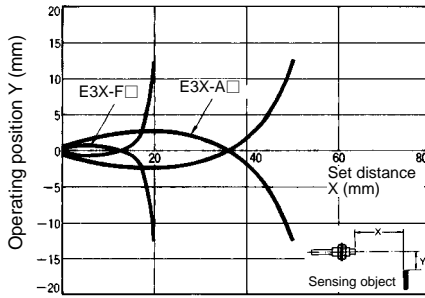

E32-DC200E

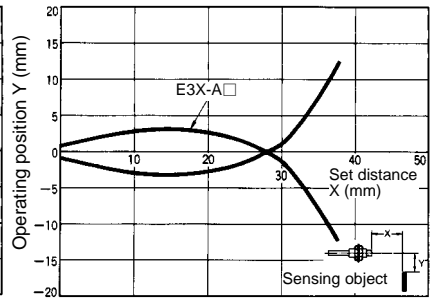

E32-D21

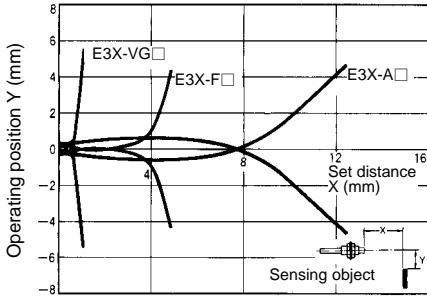

E32-D11

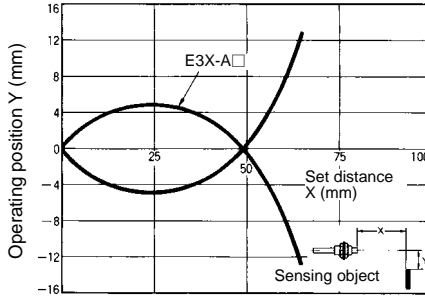

E32-D33

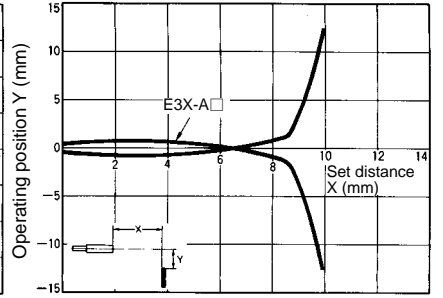

E32-CC200

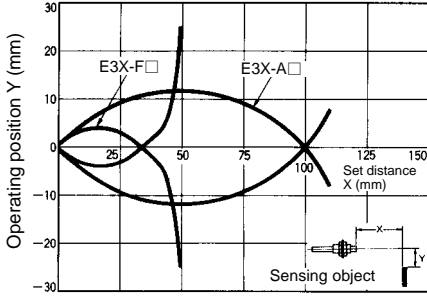

E32-D32L

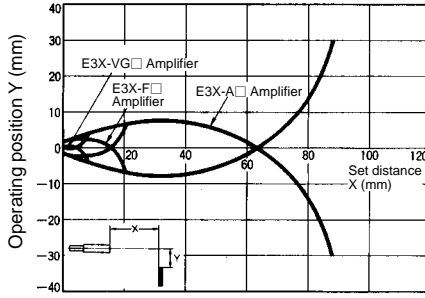

E32-D14L

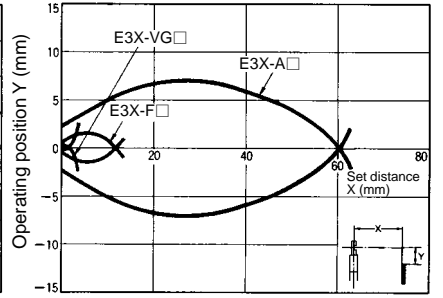

E32-D24

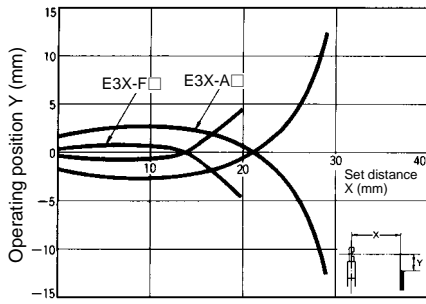

E32-D12F

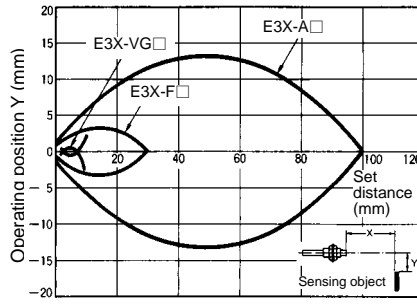

E32-D51

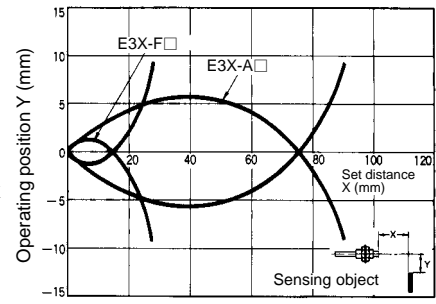

E32-D61

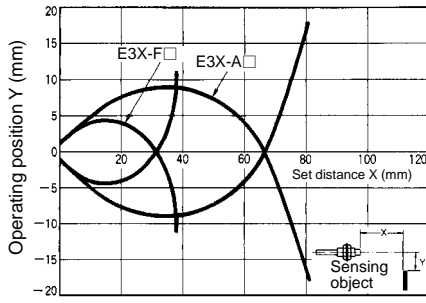

E32-D73

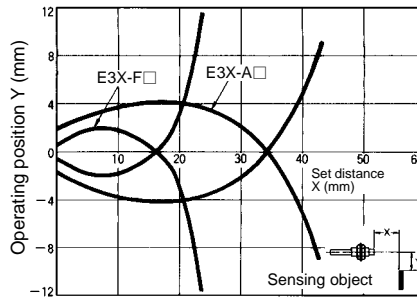

E32-R16

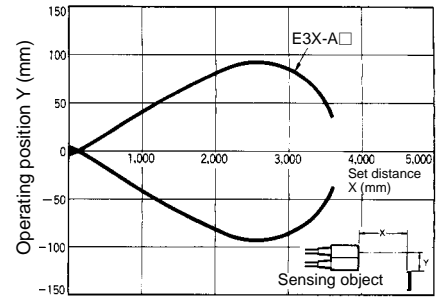

E32-L25L

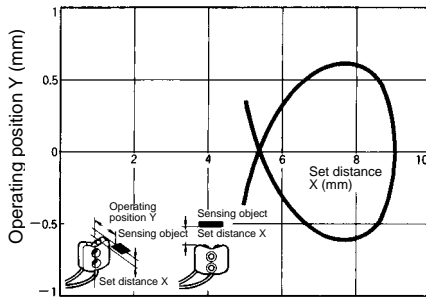

■ Parallel Operating Range (Typical)

Sensitivity Level: Maximum

E3X-H11

E32-TC200

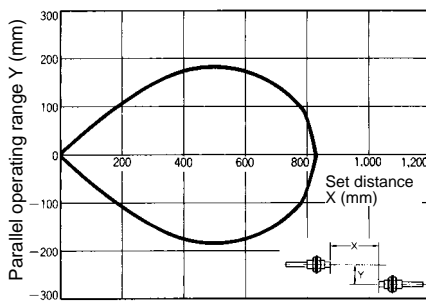

E32-TC200 + E39-F2

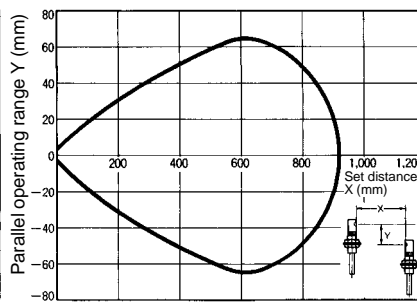

E32-T11L

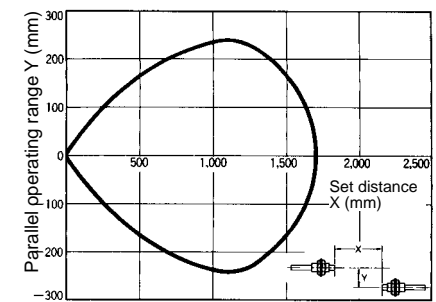

E32-T11L + E39-F1

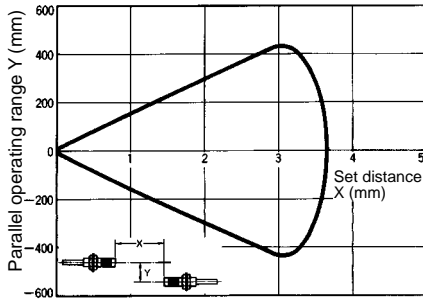

E32-T11L + E39-F2

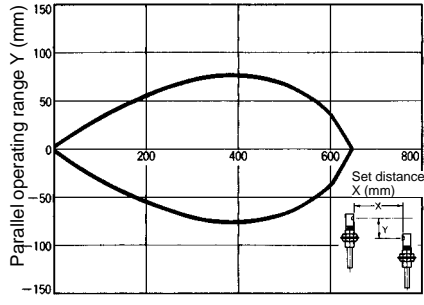

E32-T21L

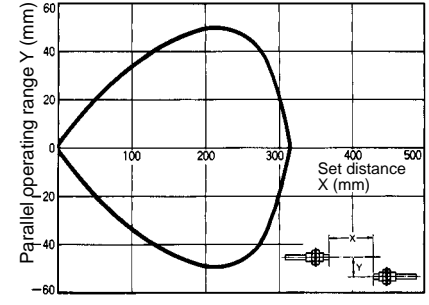

E32-T22

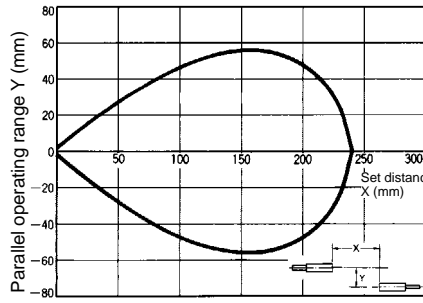

E32-T11

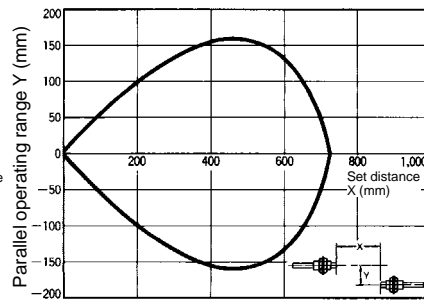

E32-T21

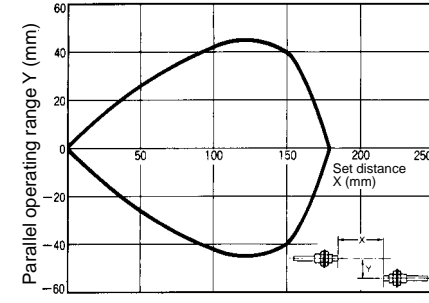

E32-T14L

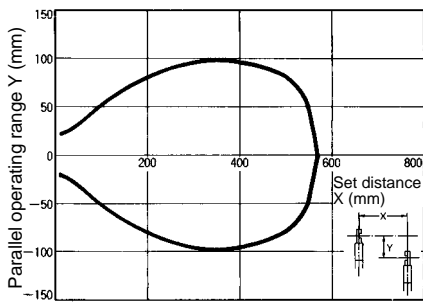

E32-T24

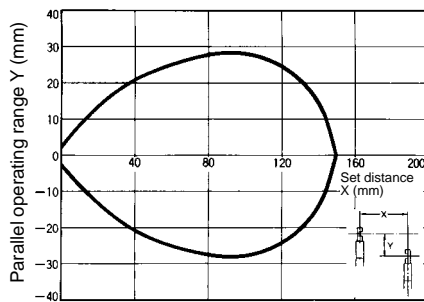

E32-T14

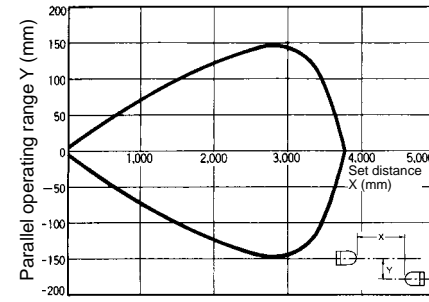

E32-T17L

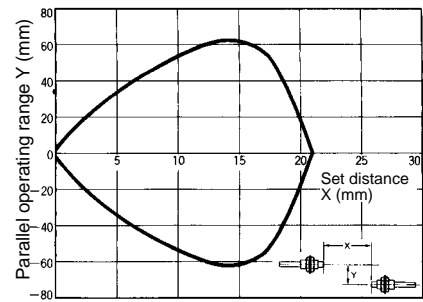

E32-T12F

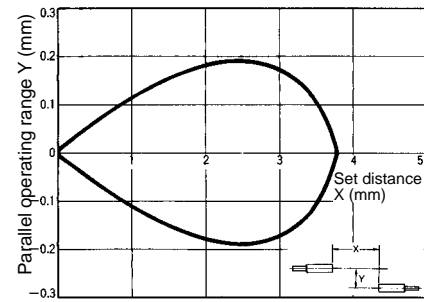

E32-M21

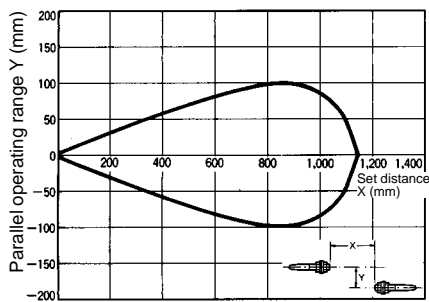

E32-T51

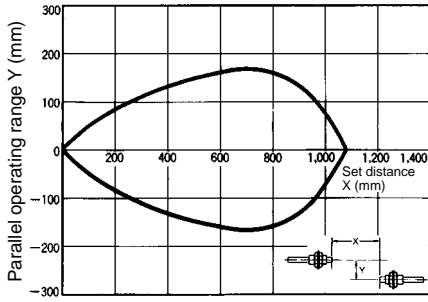

E32-T61

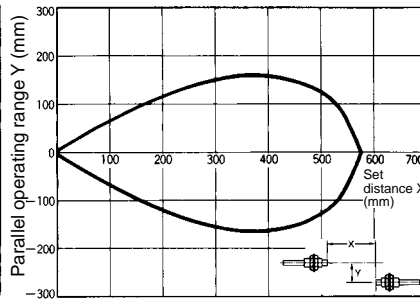

E32-T22S

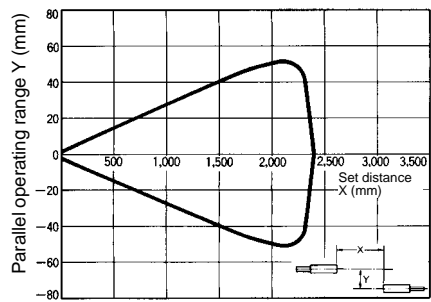

E32-T24S

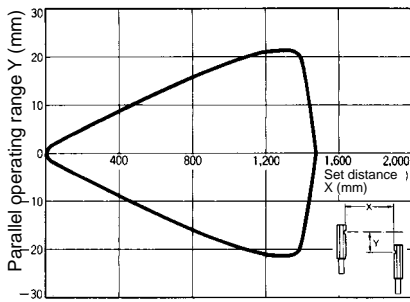

E32-T54

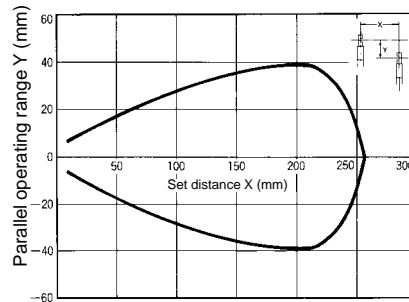

E32-T14F

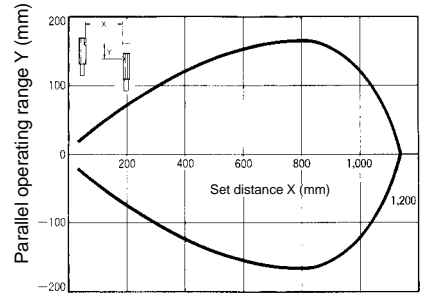

E3X-A□□/-F□□/-VG□□

E32-TC200

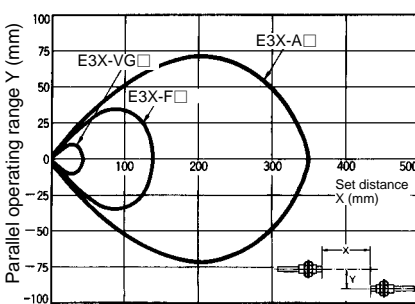

E32-TC200 + E39-F2

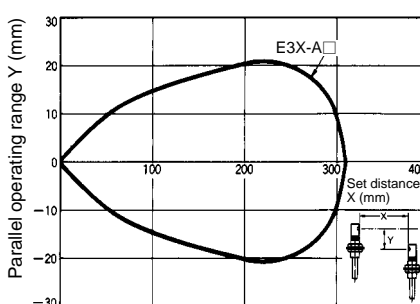

E32-T11L/T12L

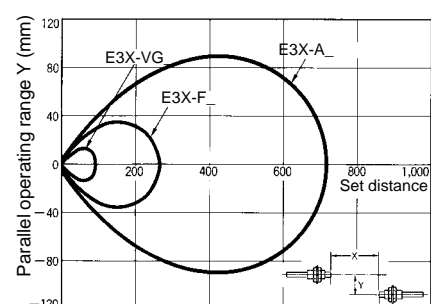

E32-T11L + E39-F1

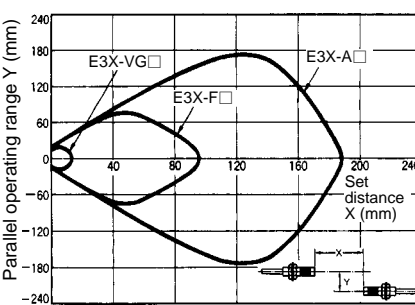

E32-T11L + E39-F2

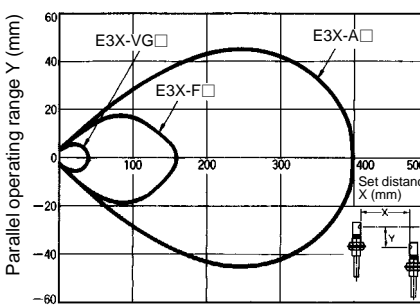

E32-T21L/T22L

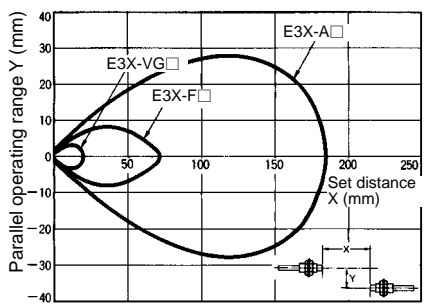

E32-TC200E

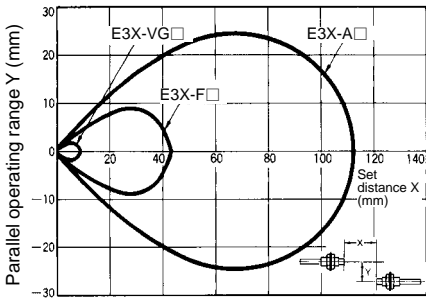

E32-T11

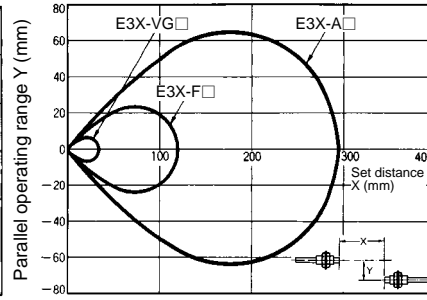

E32-T21

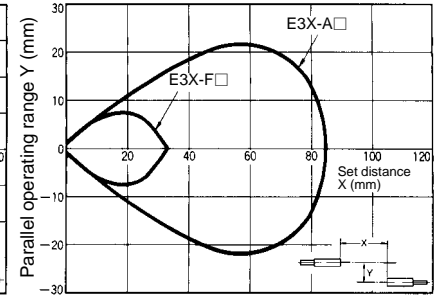

E32-T14L

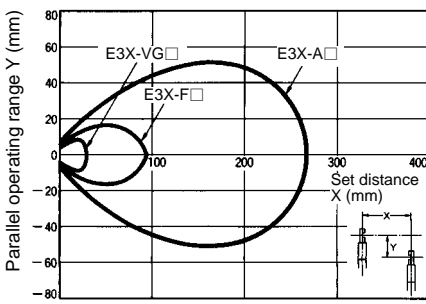

E32-T24

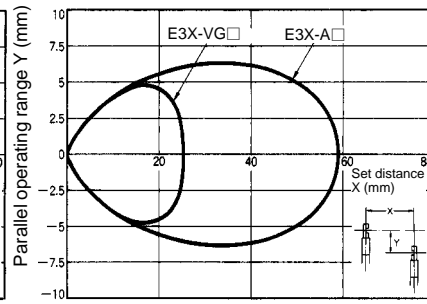

E32-T14

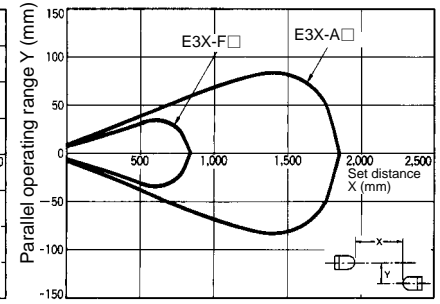

E32-T54

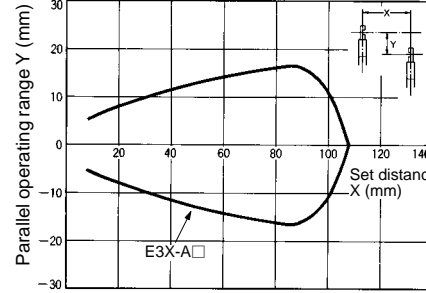

E32-T14F

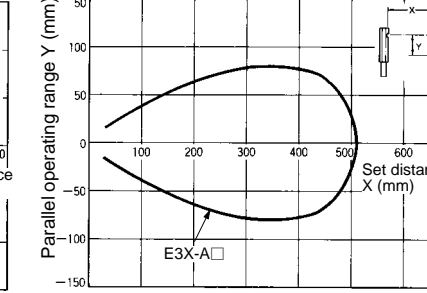

E32-T17L

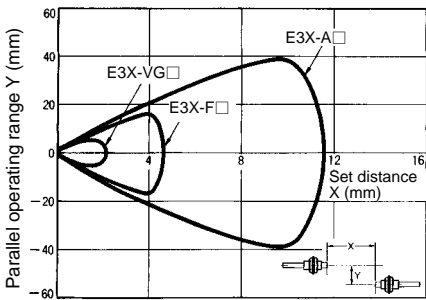

E32-T12F

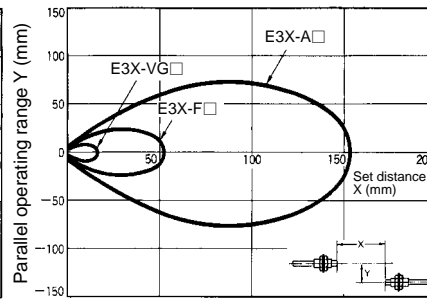

E32-M21

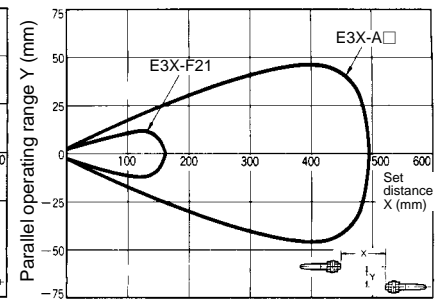

E32-T51

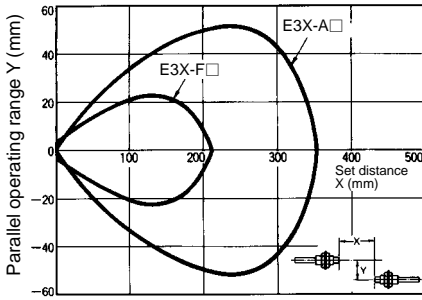

E32-T61

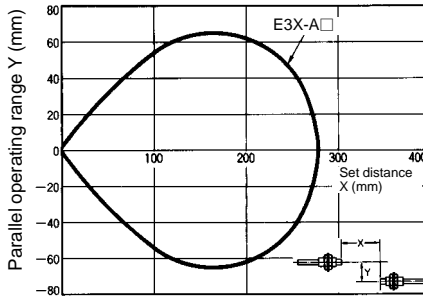

E32-T61 + E39-F1

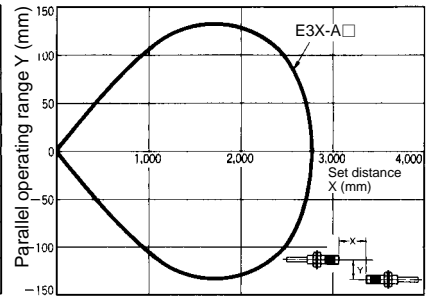

E32-T22S

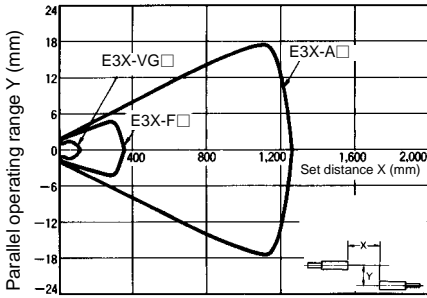

E32-T24S

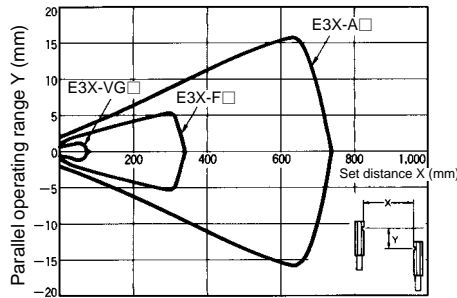

Number of Turns of Sensitivity Adjuster and Sensing Distance (Typical)

E3X-H/E32-D11L

Sensing Object: White Paper of 5 x 5 cm

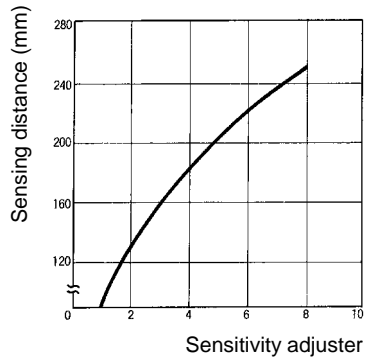

E3X-A, -F/E32-D11L

Sensing Object: White Paper of 10 x 10 cm with E3X-A and 5 x 5 cm with E3X-F

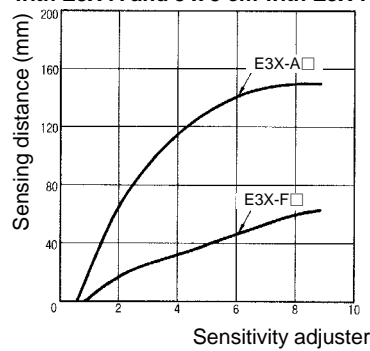

Color Sensing (Typical) Green Light Source E3X-VG /E32-D11L

The following graph shows the relationship between colors and the number of turns of the sensitivity adjuster when the E32-D11L is in operation with the sensing distance adjusted to 5 mm.

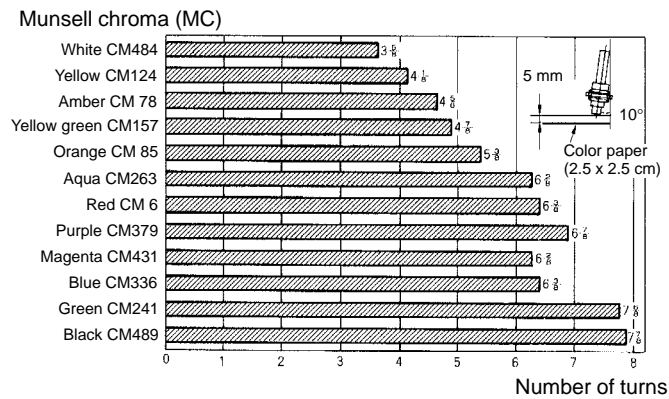

Nomenclature

E3X-H11

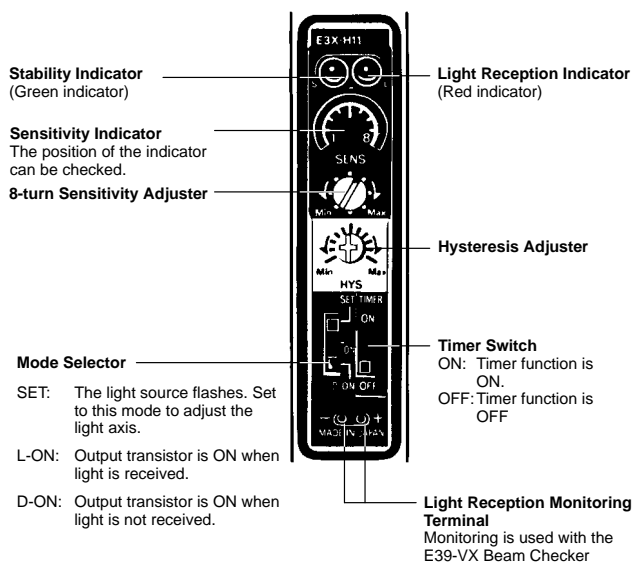

E3X-A11/A41 E3X-VG11

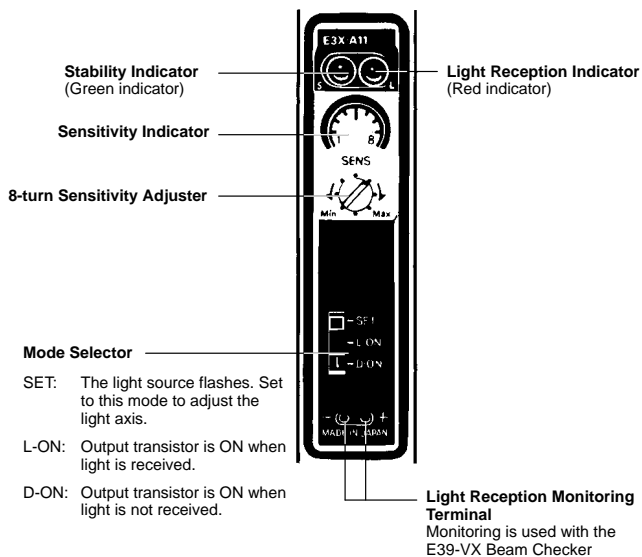

E3X-A21/A51 E3X-F21/F51 E3X-VG21

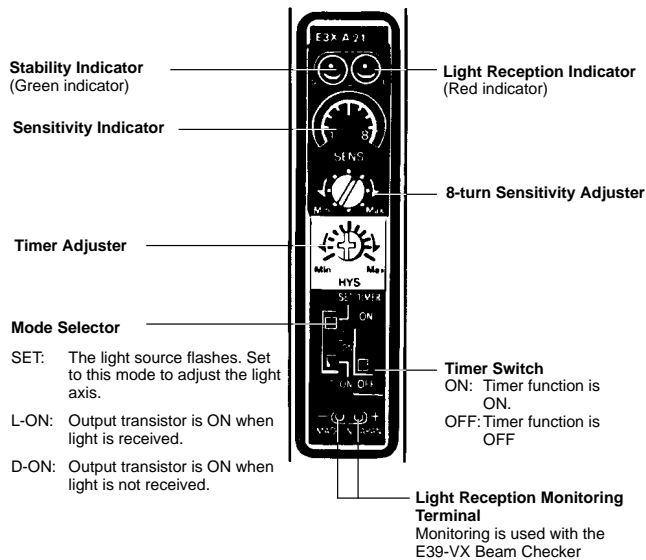















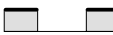
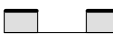



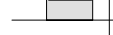











Note: Set the mode selector to L-ON or D-ON after the light axis is adjusted.

Operation

■ Output Circuits











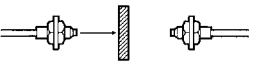

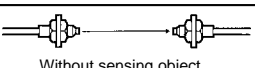

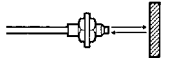

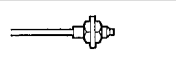

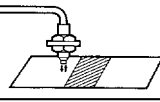
Type	Model	Mode switch	Output transistor	Output circuit
NPN	E3X-H11 E3X-A11 E3X-VG11	Light ON	ON when light is received.	
		Dark ON	ON when light is not received.	
	E3X-A21 E3X-VG21 E3X-F21	Light ON	ON when light is received.	
		Dark ON	ON when light is not received.	
PNP	E3X-A41	Light ON	ON when light is received.	
		Dark ON	ON when light is not received.	
	E3X-A51 E3X-F51	Light ON	ON when light is received.	
		Dark ON	ON when light is not received.	

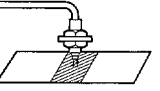
■ Timing Charts

Type	Model	Mode switch	Output transistor	Timing chart
NPN	E3X-H11 E3X-A11 E3X-VG11	Light ON	ON when light is received.	Light received Light not received  Light indicator (Red) ON OFF  Output transistor ON OFF  Load (relay) Operate Release  (Between brown and black)
		Dark ON	ON when light is not received.	Light received Light not received  Light indicator (Red) ON OFF  Output transistor ON OFF  Load (relay) Operate Release  (Between brown and black)
	E3X-A21 E3X-VG21 E3X-F21	Light ON	ON when light is received.	Light received Light not received  Light indicator (Red) ON OFF  Output transistor ON OFF  Load (relay) Operate Release  (Between brown and black)
		Dark ON	ON when light is not received.	Light received Light not received  Light indicator (Red) ON OFF  Output transistor ON OFF  Load (relay) Operate Release  (Between brown and black)
PNP	E3X-A41	Light ON	ON when light is received.	Light received Light not received  Light indicator (Red) ON OFF  Output transistor ON OFF  Load (relay) Operate Release  (Between blue and black)
		Dark ON	ON when light is not received.	Light received Light not received  Light indicator (Red) ON OFF  Output transistor ON OFF  Load (relay) Operate Release  (Between blue and black)
	E3X-A51 E3X-F51	Light ON	ON when light is received.	Light received Light not received  Light indicator (Red) ON OFF  Output transistor ON OFF  Load (relay) Operate Release  (Between blue and black)
		Dark ON	ON when light is not received.	Light received Light not received  Light indicator (Red) ON OFF  Output transistor ON OFF  Load (relay) Operate Release  (Between blue and black)

■ Sensitivity Adjustments

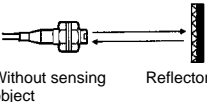
Turn the sensitivity adjuster and adjust the sensitivity with or without sensing objects to satisfy the following conditions.

Sensing method		Sensing	Light	Indicators
Through-beam		 With sensing object	Interrupted	Green  Red  Green: ON Red: OFF
		 Without sensing object	Incident	Green  Red  Green: ON Red: ON
Reflective	Sensing	 With sensing object	Incident	Green  Red  Green: ON Red: ON
		 Without sensing object	Interrupted	Green  Red  Green: ON Red: OFF
	Sensing of the difference in color or shade	 Color that has a high reflection ratio	Incident	Green  Red  Green: ON Red: ON
		 Color that has a low reflection ratio	Interrupted	Green  Red  Green: ON Red: OFF
Retroreflective		 With sensing object Reflector	Interrupted	Green  Red  Green: ON Red: OFF
		 Without sensing object Reflector	Incident	Green  Red  Green: ON Red: ON

Note: 1. If the indicators operate as described in the table, the E3X can operate in stable condition within the rated temperature range.
 2. Even when the green indicator is OFF, the E3X will operate stably if the operating temperature change since the initial settings is within $\pm 10^{\circ}\text{C}$.

■ Light Axis Adjustment with Flashing Function

1. Set the mode selector to SET.
2. Adjust the light axis by moving the fiber with the light flashing.

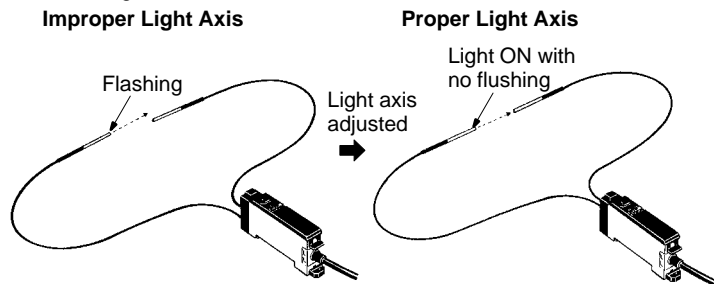
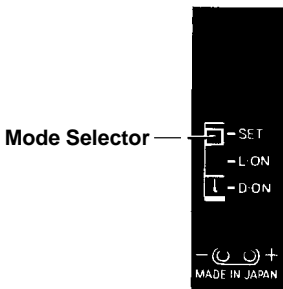

3. Set the mode selector to L-ON or D-ON after the light axis is adjusted.
4. After adjusting the light axis, be sure to change the mode to "L-ON" or "D-ON" before actually operating the Unit.

Alarm Output Function

With this function, the E3X checks changes in environmental conditions (especially a change in the ambient temperature) and self-diagnoses the resistance against the changes. The result is shown by the indicators or an output signal.

Stability Indicator
(Green Indicator)

Light Reception Indicator
(Red Indicator)

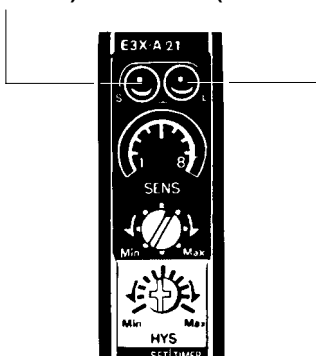

Displays

- **Stability Indicator:** Changes in environmental conditions (changes in the ambient temperature, the operating voltage, or the volume of dust) are checked and the resistance against them are self-diagnosed. The result is shown via the indicator.
- **Light Reception Indicator:** The amount of light received is indicated by this indicator.

Output

- The resistance against changes in environmental conditions is indicated by the indicator and the result is output.

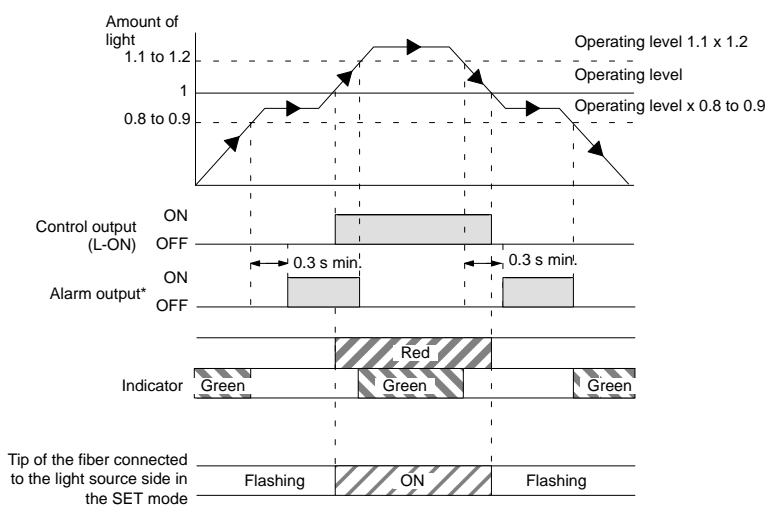

*If the alarm output is ON when the sensing object is moving at low speed, use the E3X with an ON-delay timer circuit.

■ Variable Hysteresis Function (E3X-H11)

Sensing of Plate Level Differences

(If sensing is impossible with the hysteresis value set to maximum)

Refer to the following when using the hysteresis adjuster.

1. Initial Stage

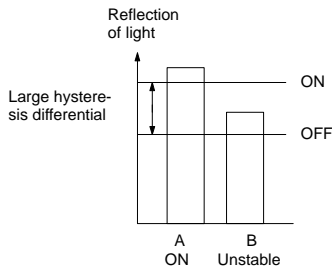

Sensing operation is not stable because zone B is within the hysteresis differential range.

2. Sensitivity Adjustment

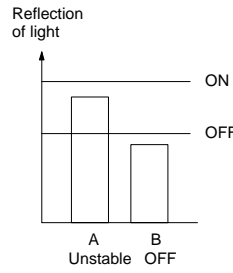

Reduce the sensitivity of the E3X with the sensitivity adjuster and turn OFF zone B.

3. Variable Hysteresis

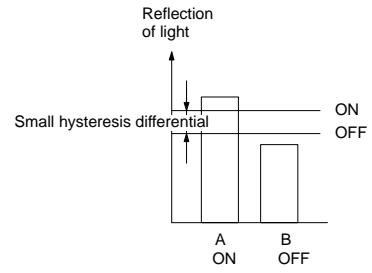

Reduce the hysteresis value with the hysteresis adjuster so that zone A will be ON.

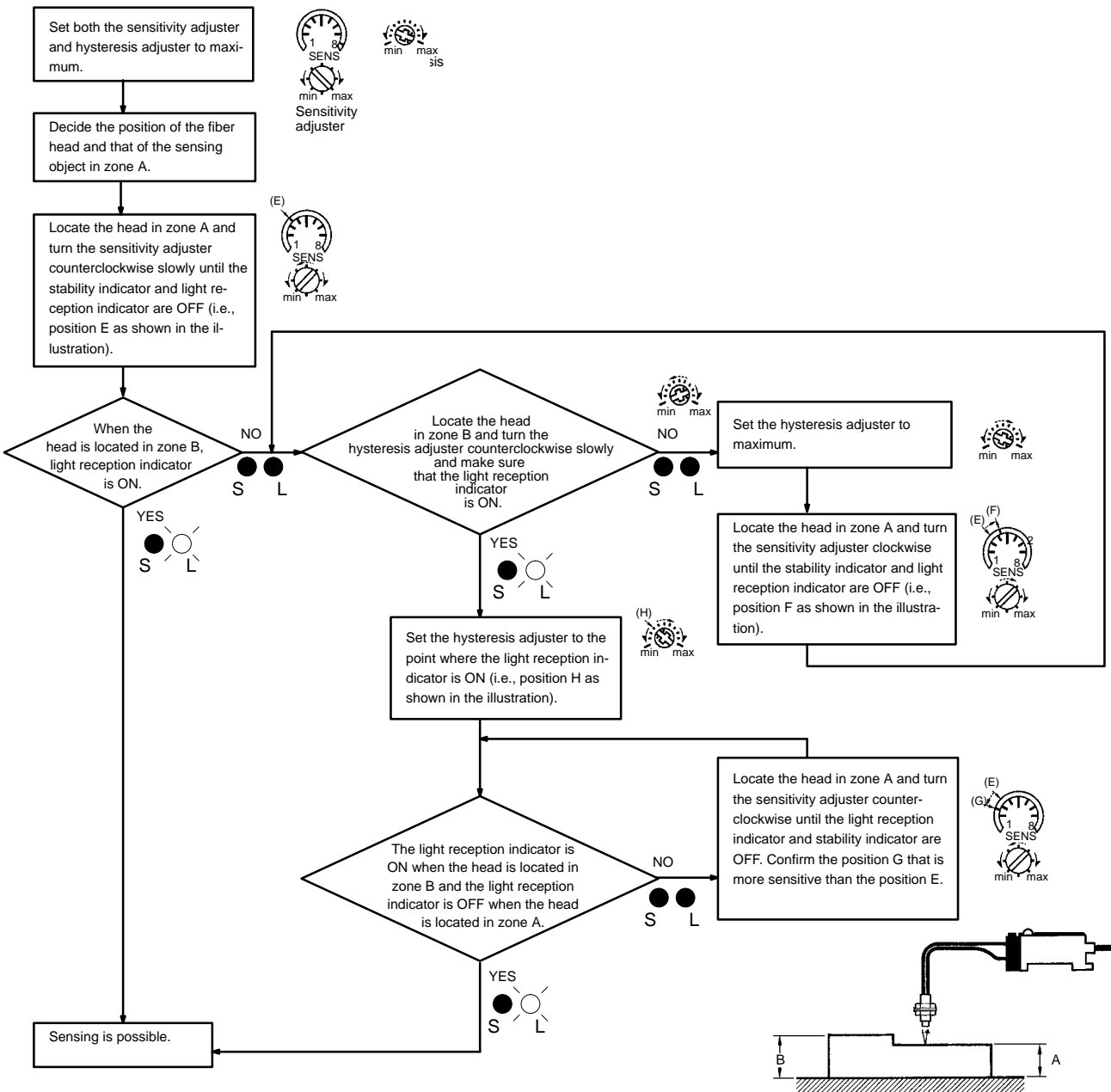

■ External Check Input Function (E3X-A21/51, E3X-F21/F51, E3X-VG21)

With this function, light projection can be stopped when desired. The operation of the Sensor can be checked with this function before the E3X is placed into actual operation.

E3X-A□□

Light is emitted from the projection fiber head when the external check input is ON. The Sensor, however, will not operate.

E3X-F□□/-VG□□

No light is emitted from the projection fiber head when external check input is ON.

NPN Type

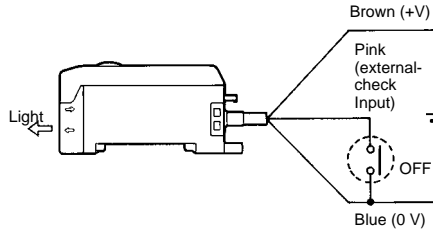
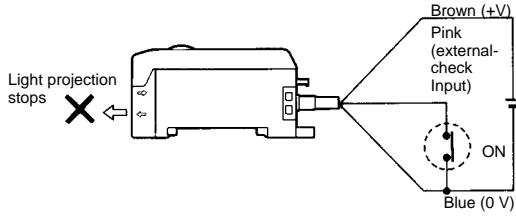

PNP Type

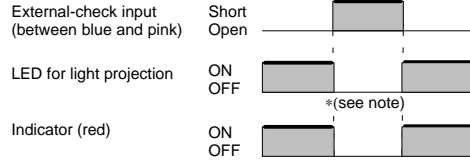
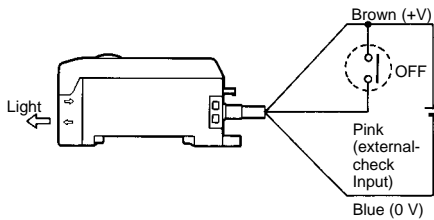
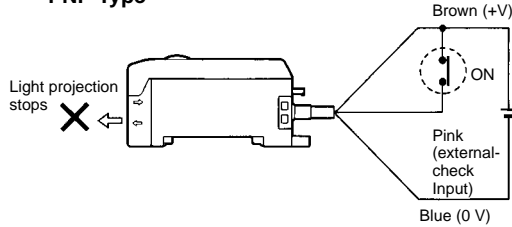

By short-circuiting the pink and blue cords, light projection can be stopped* (with a short-circuit current of 0.2 mA max.).

*Only the E3X-A emits light from the light-emitting diode during external-check input.

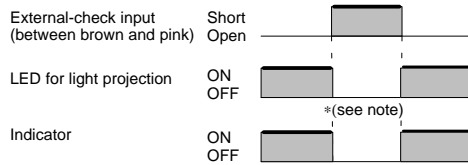

By short-circuiting the brown and pink cords, light projection can be stopped* (with a short-circuit current of 0.2 mA max.).

*Only the E3X-A emits light from the light-emitting diode during external-check input.

Dimensions

Note: All units are in millimeters unless otherwise indicated.

■ Amplifier Units

E3X-A/H/F/VG

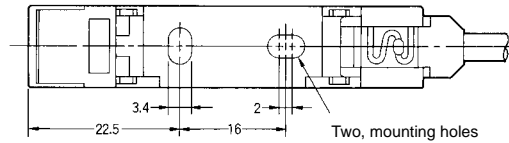
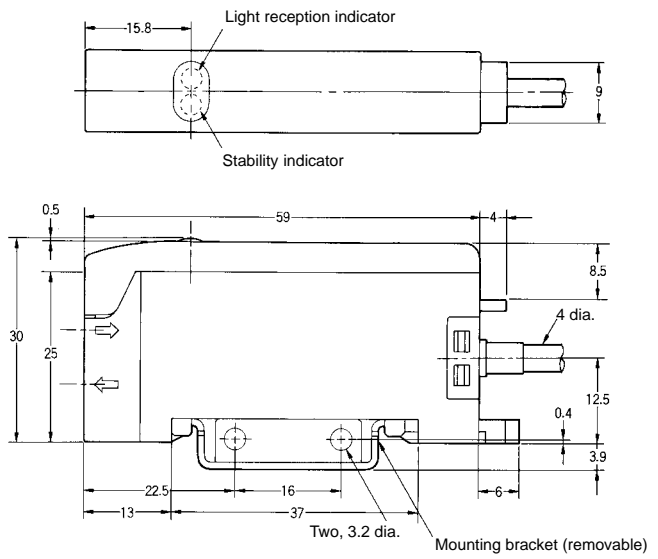
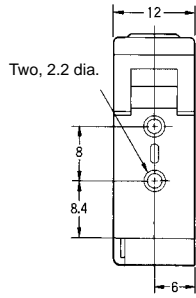
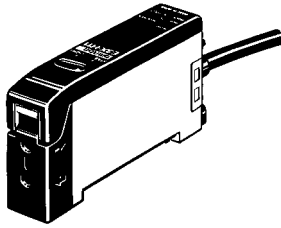

Cord: 2-m polyvinyl chloride-covered cord (4-mm dia., 5 cores*)
 Weight: Approx. 100 g
 *The cords for the E3X-A11/-A41/-H11/-VG11 have 3 cores.

Fiber Units

Through-beam (Sold in Pairs)

 Indicates models that allow free cutting. Models without this mark do not allow free cutting.

E32-T11L 

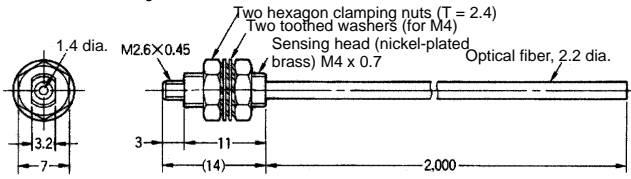

E32-T12L 

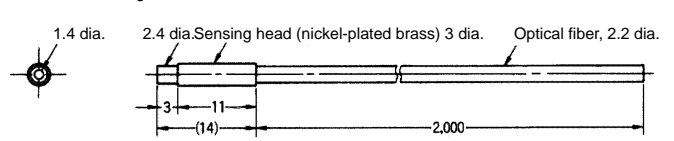

E32-T21L 

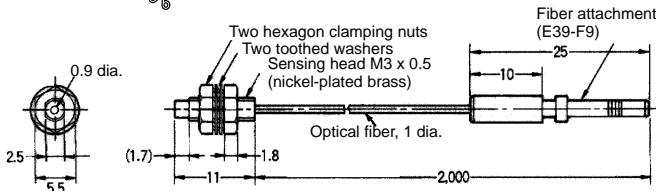

E32-T22L 

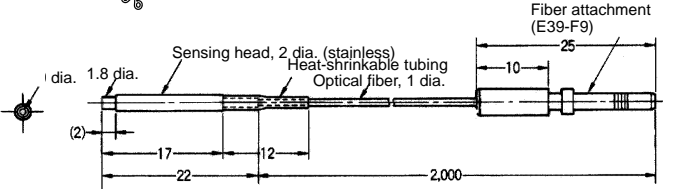

E32-TC200 

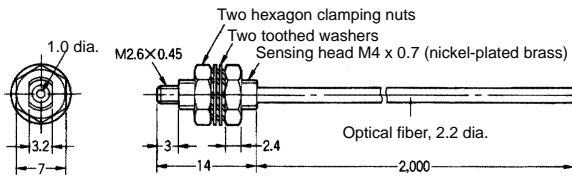

E32-TC200B
E32-TC200B4 

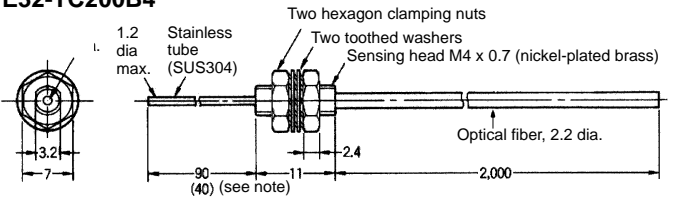

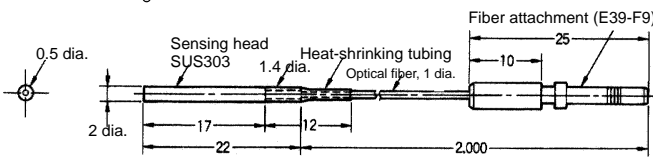

Note: The value in the parentheses is for the E32-TC200B4.

E32-T22 

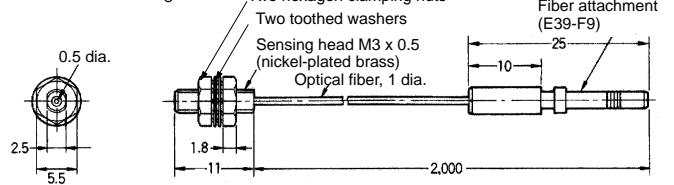

E32-TC200E 



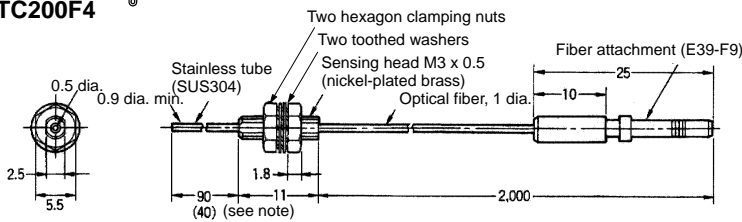

E32-TC200F
E32-TC200F4 

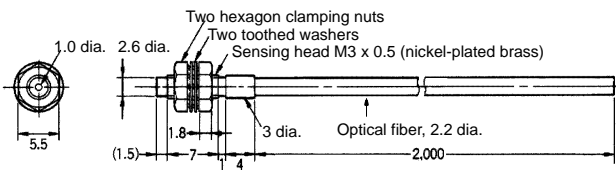

Note: The value in the parentheses is for the E32-TC200F4.

E32-TC200A 



E32-T11 

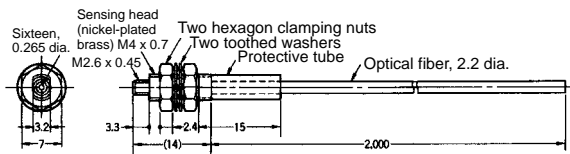

E32-T21

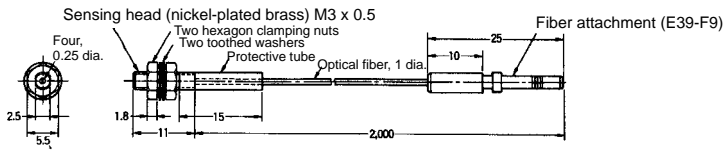

E32-T14L

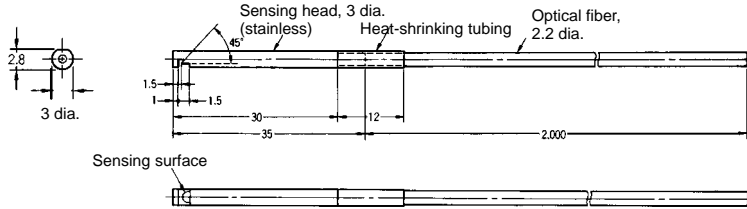

E32-T24

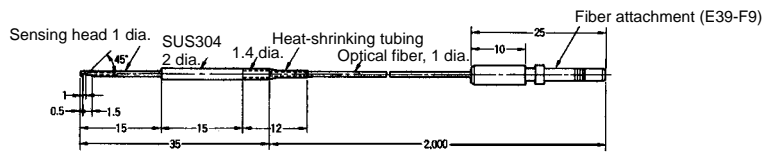

E32-T14

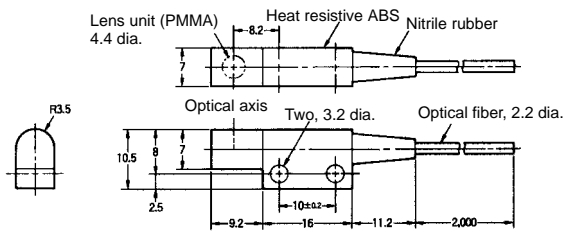

E32-T17L

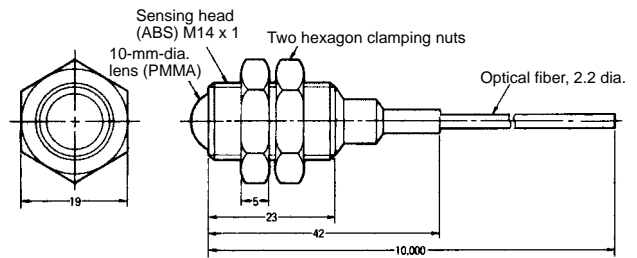

E32-T12F

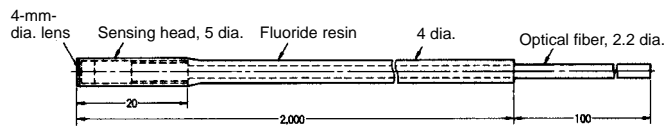

E32-T14F

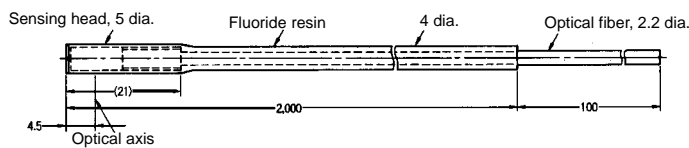

E32-T16

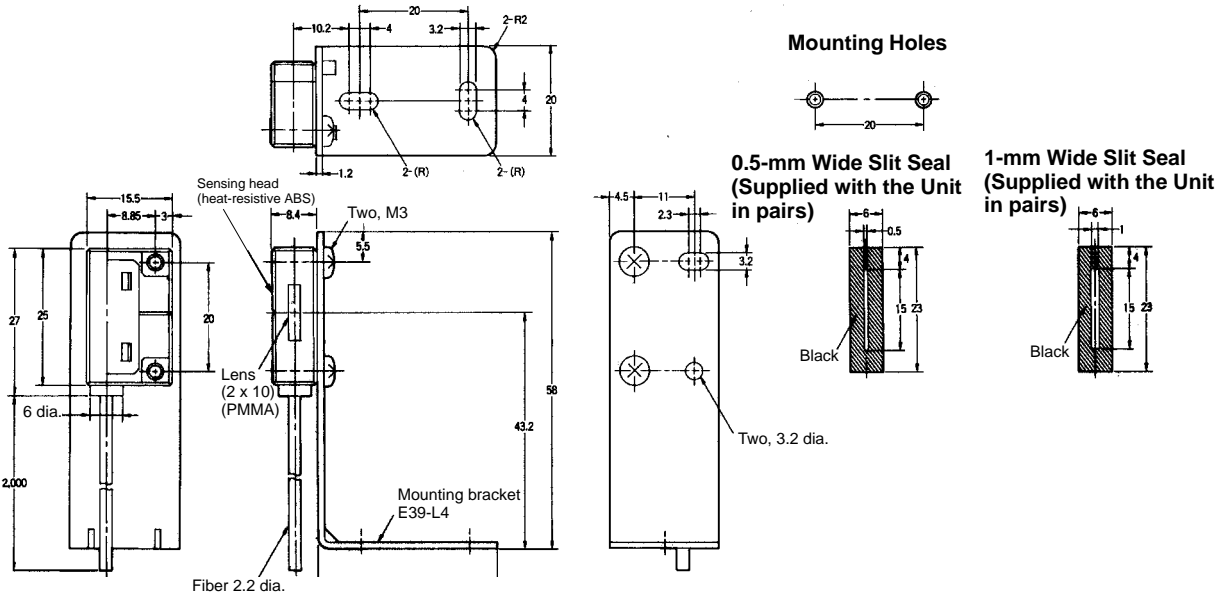

E32-T16P

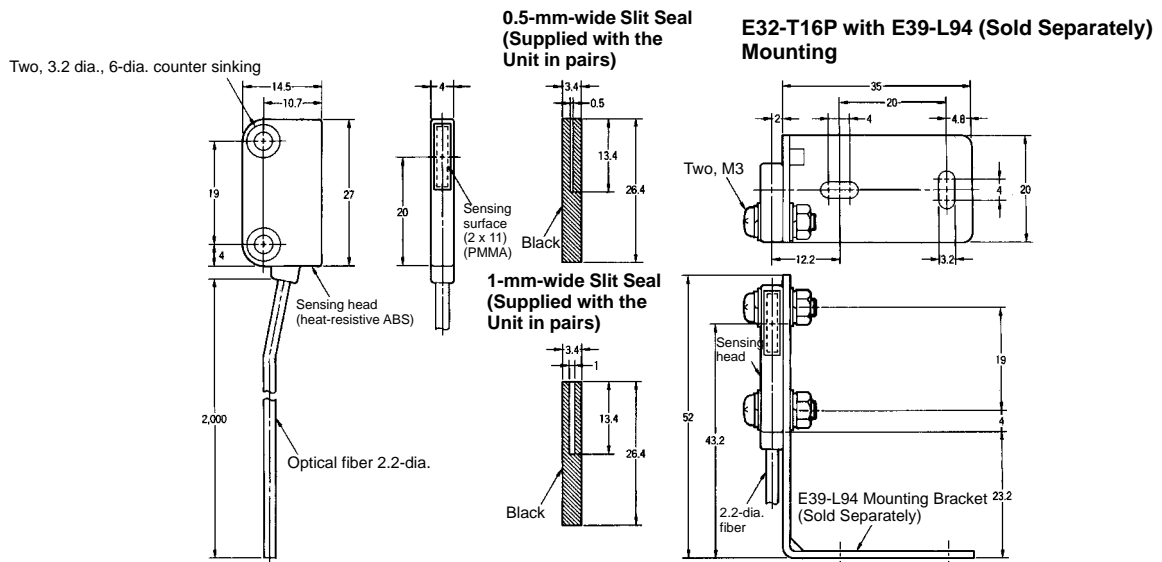

E32-M21

Note: One set of silicone tubes is black while the other set is grey for easy identification when they are connected to the emitter and receiver.

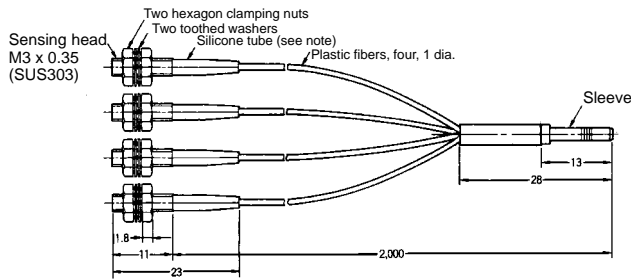

E32-T51

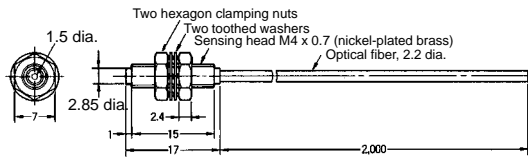

Note: Resistant temperature is 150°C.
Resistant temperature is 130°C when used continuously.

E32-T54

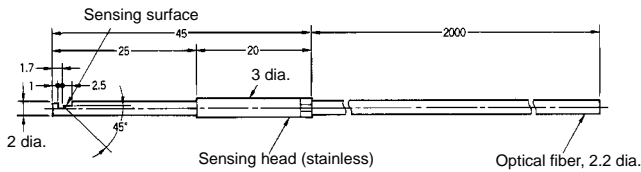

Note: Resistant temperature is 150°C.
Resistant temperature is 130°C when used continuously.

E32-T61

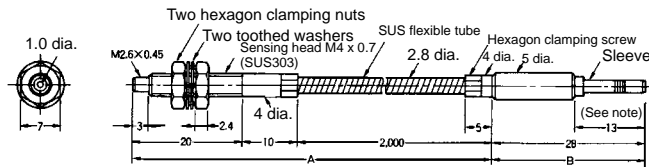

Note: Section A resists 300°C and section B (which is inserted to the Amplifier) resists 110°C.
The operating temperature of the section to be inserted (marked with *) must be within the operating temperature range of the Amplifier.

E32-T84S

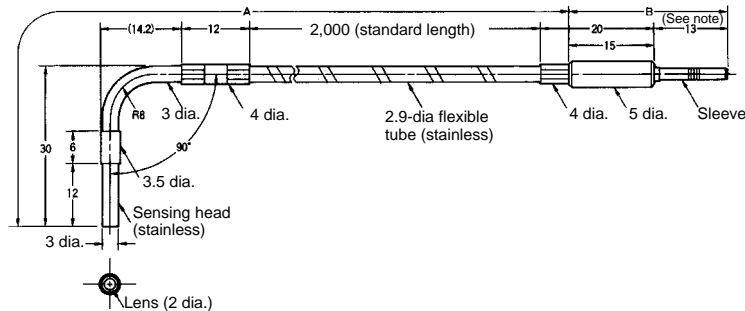



Note: Section A resists 200°C and section B (which is inserted to the Amplifier) resists 110°C.
The operating temperature of the section to be inserted (marked with *) must be within the operating temperature range of the Amplifier.

Reflective

 Indicates models that allow free cutting. Models without this mark do not allow free cutting.

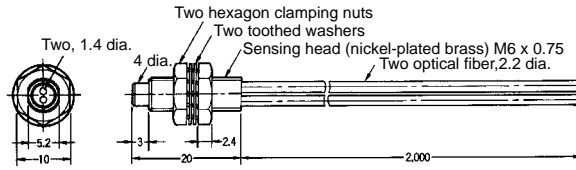
E32-D11L 



E32-D12 

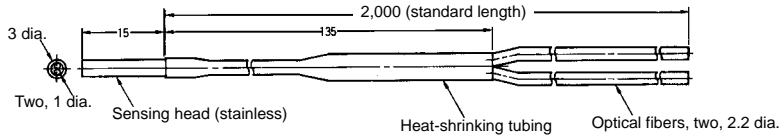

E32-D21L 

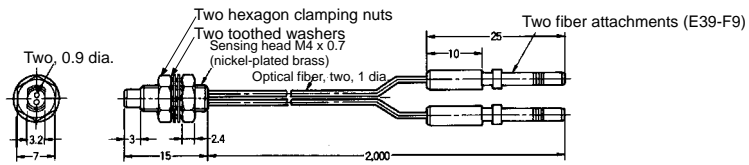

E32-D22L 

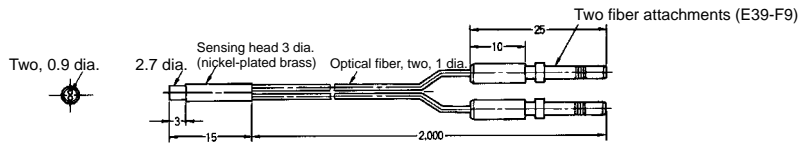

E32-DC200 

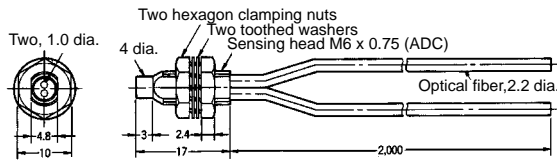

E32-DC200B 
E32-DC200B4

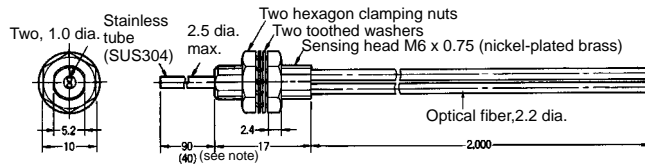

Note: The value in the parentheses is for the E32-DC200B4.

E32-DC200E 

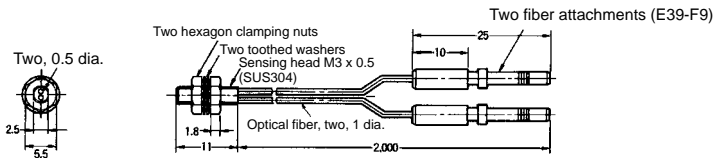

E32-DC200F
E32-DC200F4

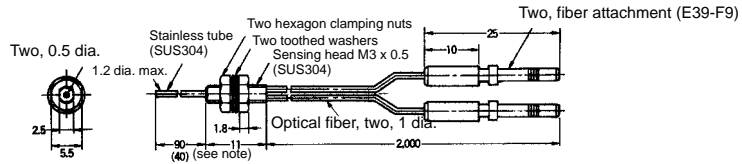

Note: The value in the parentheses is for the E32-DC200F4.

E32-D11

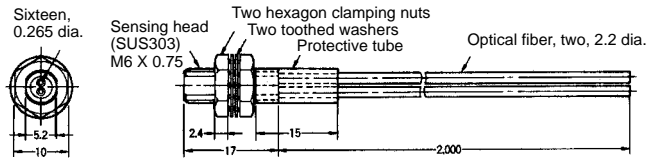

E32-D21

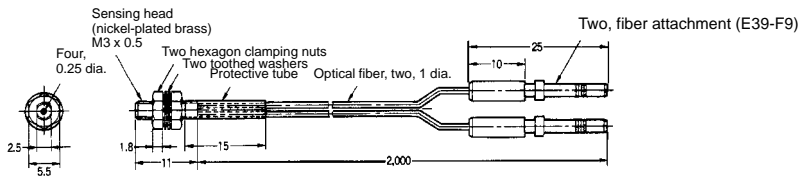

E32-D33

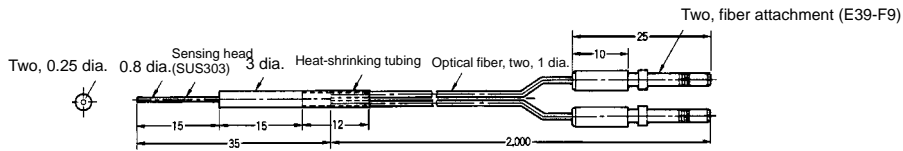

E32-CC200

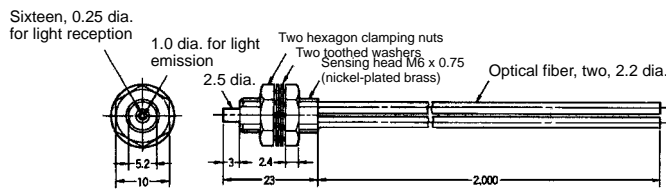

Note: The fiber for the emitter is identified by a white line.

E32-D32

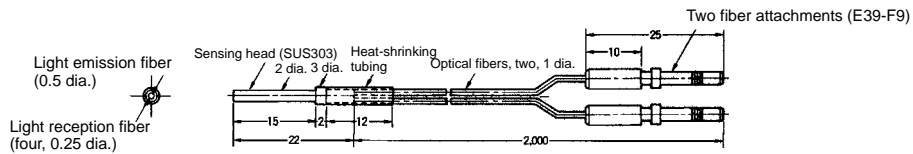

Note: The fiber for the emitter is identified by a white line.

E32-D32L

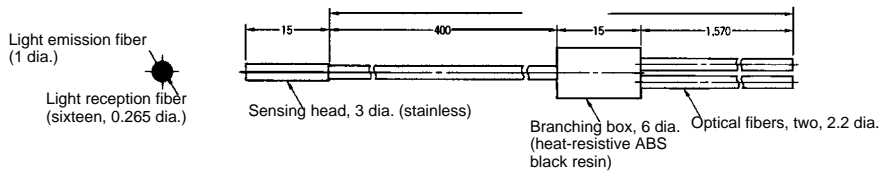

Note: The fiber for the emitter is identified by a yellow dotted line.

E32-D14L ✂

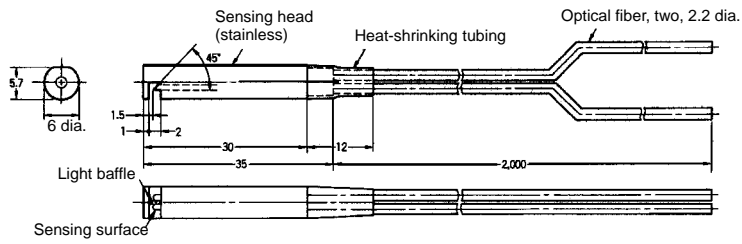

E32-D24 ✂

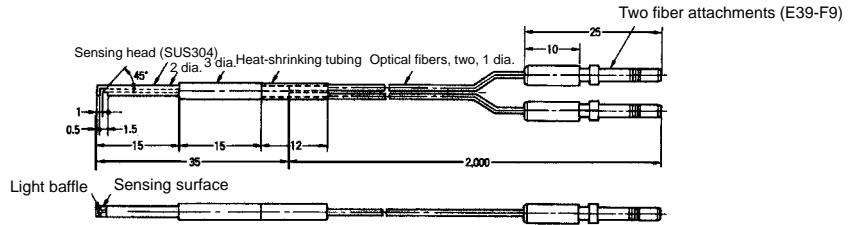

E32-D12F ✂

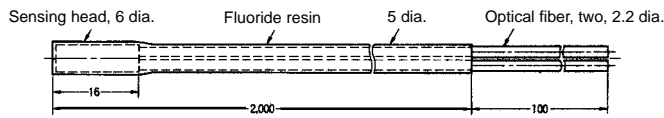

E32-D51 ✂

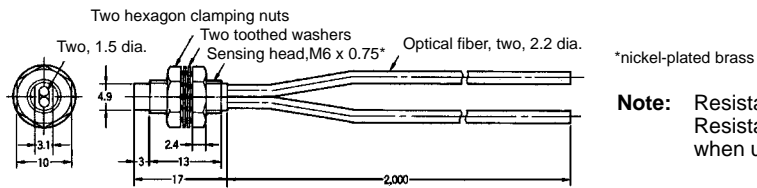

Note: Resistant temperature is 150°C.
Resistant temperature is 130°C when used continuously.

E32-D61

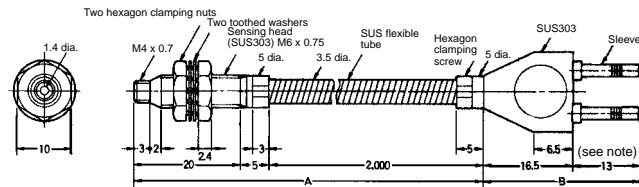

Note: Section A resists 300°C and section B (which is inserted to the Amplifier) resists 110°C. The operating temperature of the section to be inserted (marked with *) must be within the operating temperature range of the Amplifier.

E32-D73

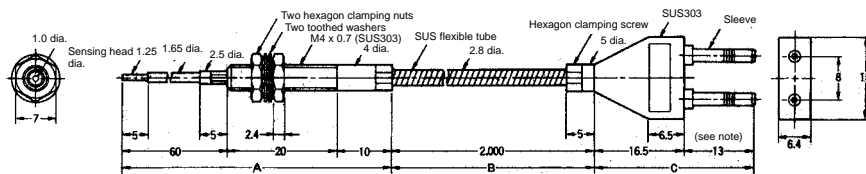

Note: Section A resists 400°C, section B resists 300°C, and section C (which is inserted to the Amplifier) resists 110°C. The operating temperature of the section to be inserted (marked with *) must be within the operating temperature range of the Amplifier.

E32-R21
 (One E39-R3 Reflector is supplied with the Sensor.)

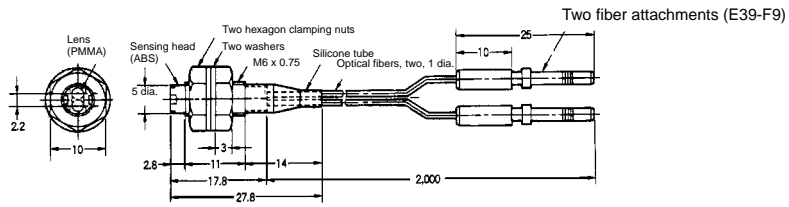

E32-R16
 (One E39-R1 Reflector is supplied with the Sensor.)

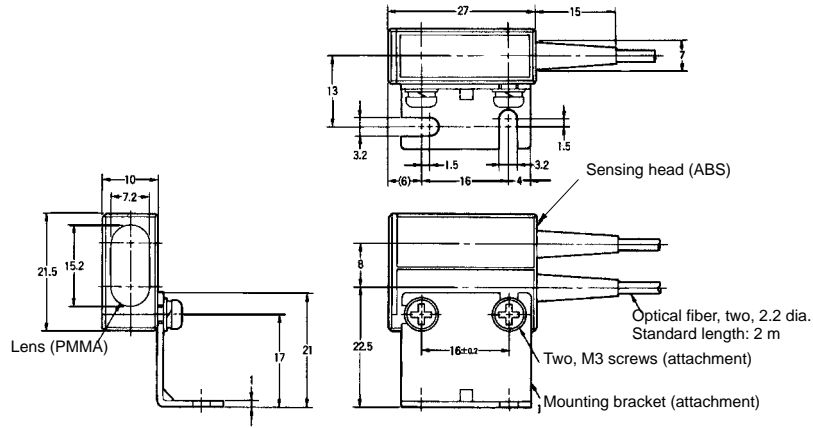

E32-L25

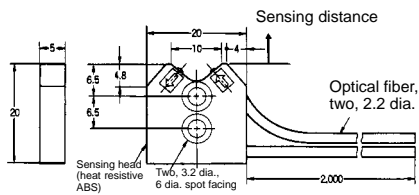

E32-L25A

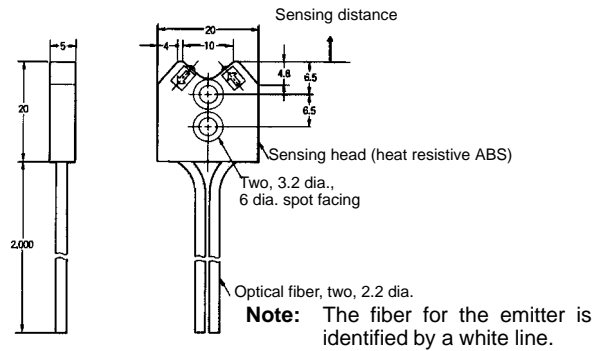

E32-L25L

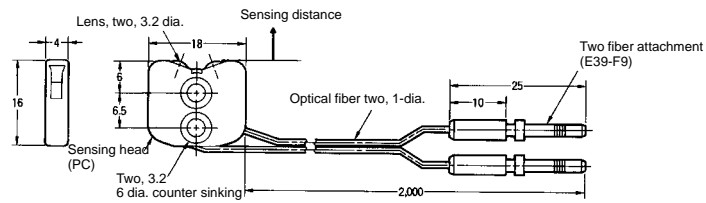

E32-L24L

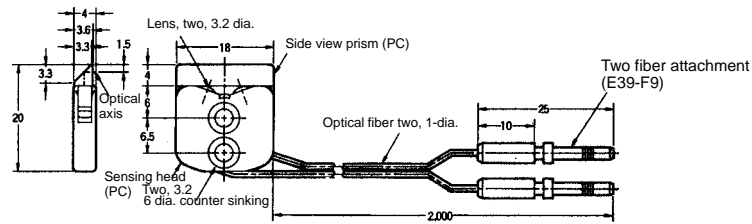

Fine Through-beam

 Indicates models that allow free cutting. Models without this mark do not allow free cutting.

E32-T22S 

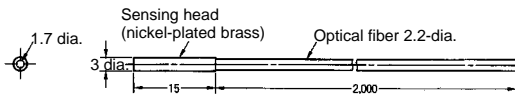

E32-T24S 

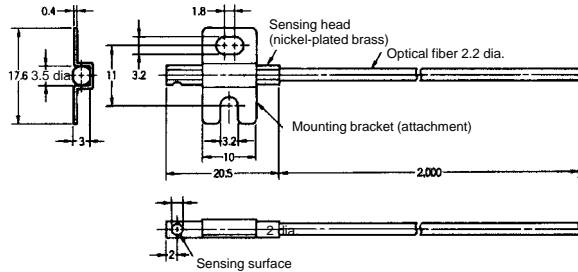

Slot Fiber Units

E32-G14 

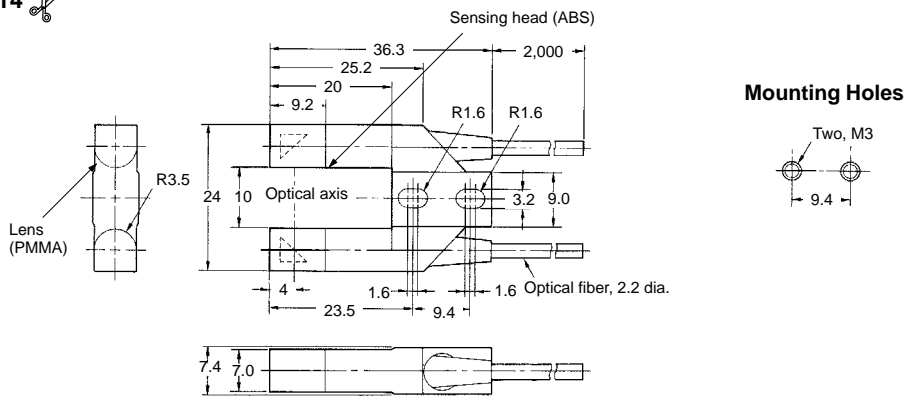

Liquid Level Fiber Units

E32-D82F1/E32-D82F2 (Liquid Contact Model)

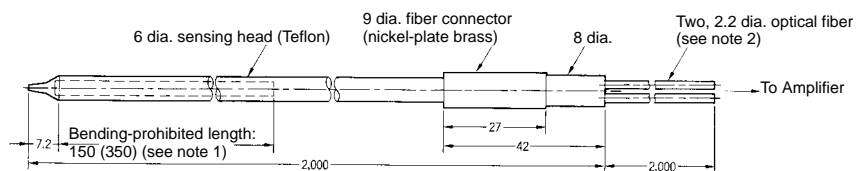

- Note:**
1. The value in the parentheses is for the E32-D82F2.
 2. Since the 2-m optical fiber on the Amplifier side is made of plastic, the fiber is trimmable.

E32-L25T (Pipe Mounting Model)

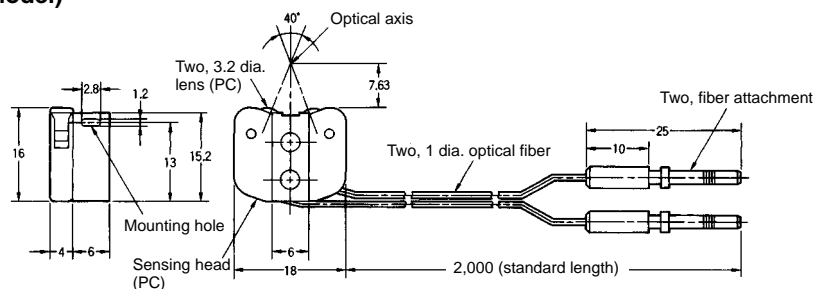

■ Reflector

Reflector (Miniature)
E39-R3 (Supplied with E32-R21)

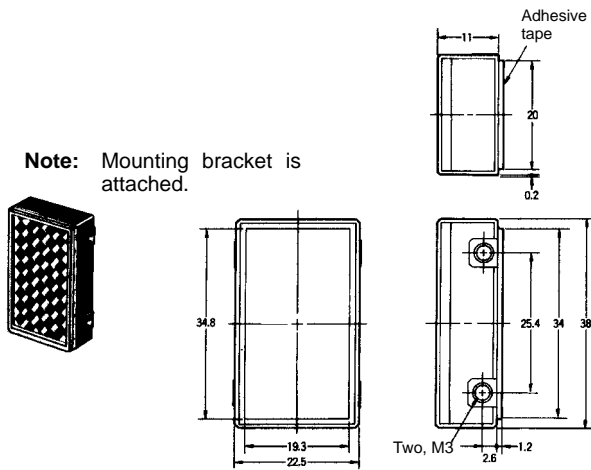

Note: Mounting bracket is attached.

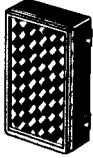

Reflector
E39-R1 (Supplied with E32-R16)

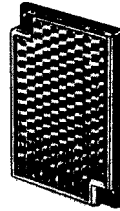
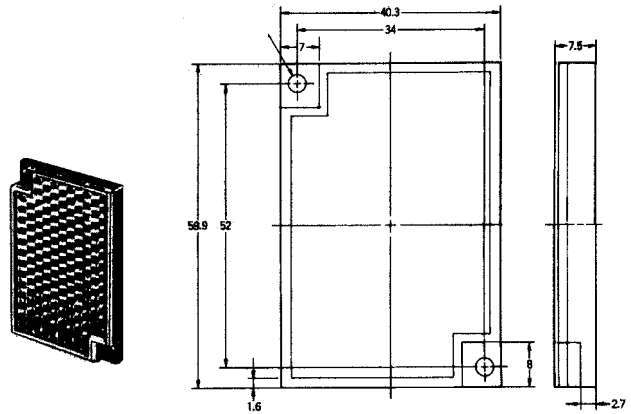

■ Attachments

E39-F1
Long-distance Lens Unit

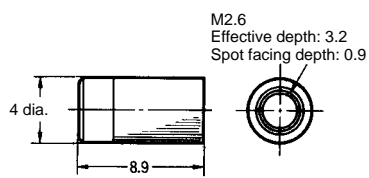

Note: One set includes two units.

E39-F2
Side-view Unit

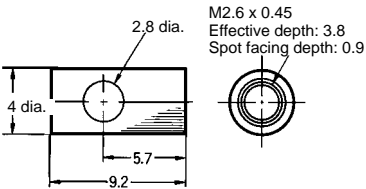

Note: One set includes two units.

E39-F3
Lens-equipped Reflective Unit

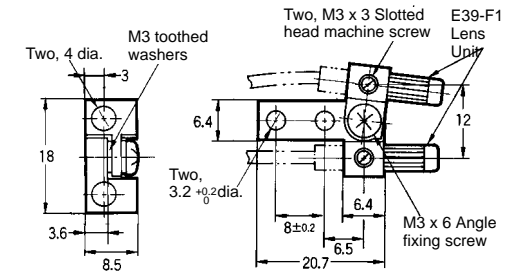

E39-F5
Side-view Reflective Unit

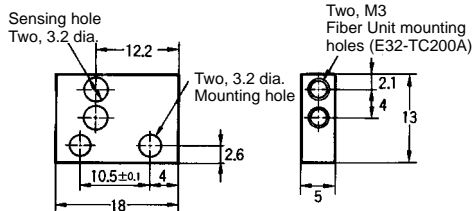

Note: When mounting, remove all of the accompanying screws first and then screw the E32-TC200A into the E39-F5 until the stopper comes into contact.

E39-F3A
Small Spot Lens Unit

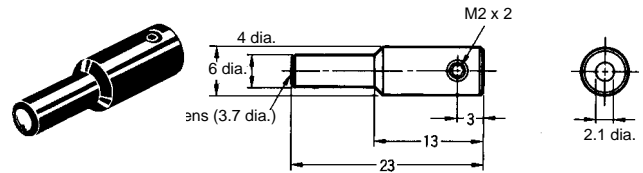

■ Protective Spiral Tubes (Sold Separately)

E39-F32A, E39-F32A5
E39-F32B, E39-F32B5

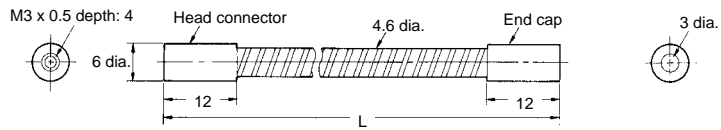
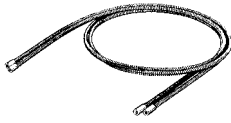

Note: 1. L is as follows:
E39-F32A and E39-F32B: 1,000
E39-F32A5, E39-F32B5: 500
2. A pair of E39-F32A(5)'s is sold as E39-F32B(5).

E39-F32C, E39-F32C5

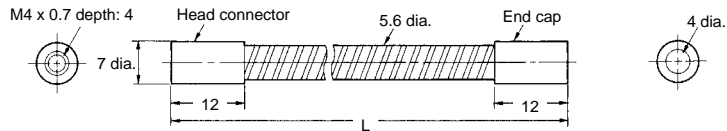

Note: L is as follows:
E39-F32C: 1,000
E39-F32C5: 500

E39-F32D, E39-F32D5

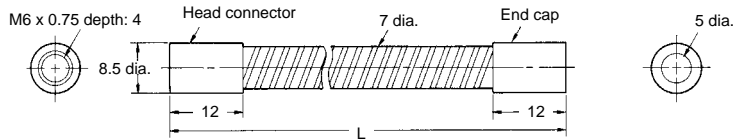

Note: L is as follows:
E39-F32D: 1,000
E39-F32D5: 500

■ Accessories

E39-F4 Fiber Cutter (Attached)

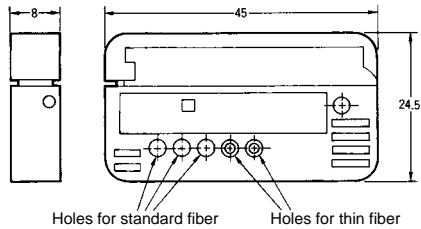
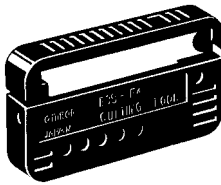

E39-F9 Attachment for Thin Fiber (Attached)

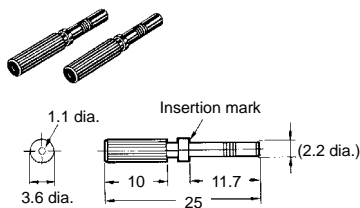

Note: One set includes two Units.

E39-F10 Fiber Connector (Sold Separately)

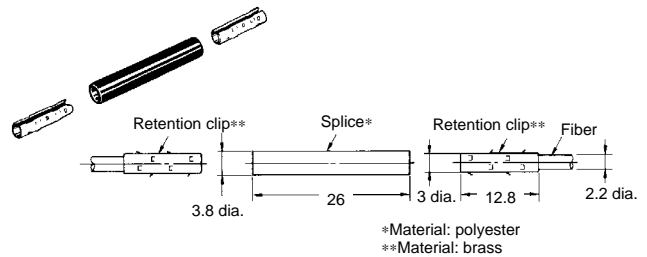

E39-G3 Manual Sensitivity Adjustment Knob

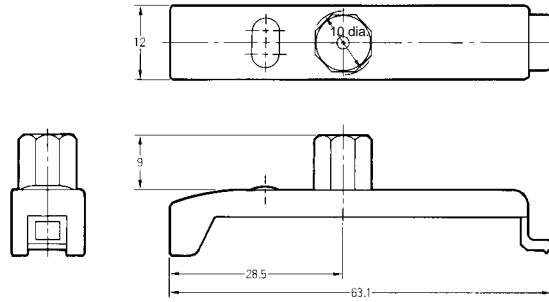

E39-G4 Protective Cover

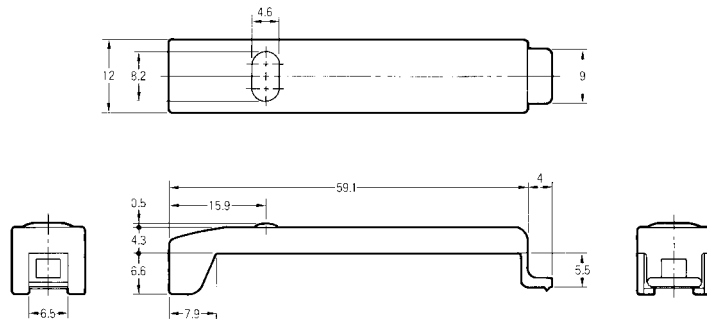

Installation

S3D2 Sensor Controller

Recommended for Simple Control Applications and as a Sensor Power Supply

Supply voltage	Output	Function	Model
100 to 240 VAC	Relay	AND, OR	S3D2-AK
		AND, OR, and timer	S3D2-CK
		Flip-flop	S3D2-BK
	Transistor	AND, OR, and timer	S3D2-CC
	Relay	2 inputs and 2 outputs	S3D2-DK
2 inputs and 2 outputs, and timer		S3D2-EK	
24 VDC	Relay	AND, OR	S3D2-AKD
		AND, OR, and timer	S3D2-CKD

■ Connections

Connection to S3D2 Sensor Controller

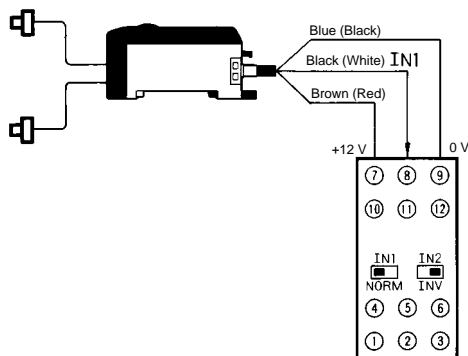

Up to two Sensors can be connected.

Precautions

General

Do not impose any voltage exceeding the rated voltage on the E3X. Do not impose 100 VAC or more on models that operate with DC. In both cases, the E3X may be damaged.

Do not short-circuit the load connected to the E3X, otherwise the E3X may be damaged.

When supplying power to the E3X, make sure that the polarity of the power is correct, otherwise the E3X may be damaged.

The load must be connected to the E3X in operation, otherwise the E3X may be damaged.

■ Fiber Units Tightening Force

The tightening force applied to the Fiber Unit should be as follows:

Screw-mounting Model

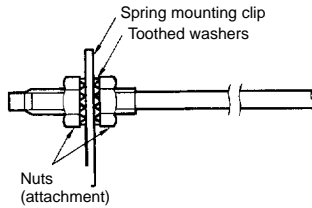

Cylindrical Model

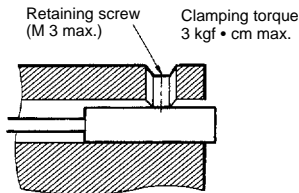

Fiber units	Clamping torque
M3/M4 screw	0.78 N • m (8 kgf • cm)
M6 screw	0.98 N • m (10 kgf • cm)
2-mm dia. column	0.29 N • m (3 kgf • cm)
3-mm dia. column	0.29 N • m (3 kgf • cm)
E32-D14L	0.98 N • m (10 kgf • cm)
E32-T12F	0.78 N • m (8 kgf • cm)
E32-D12F	0.78 N • m (8 kgf • cm)
E32-T16	0.49 N • m (5 kgf • cm)
E32-R21	0.59 N • m (6 kgf • cm)
E32-M21	Up to 5 mm to the tip: 0.49 N • m (5 kgf • cm) Up to 5 mm from the tip: 0.78 N • m (8 kgf • cm)
E32-L25A	0.78 N • m (8 kgf • cm)
E32-T16P E32-T24S E32-L24L E32-L25L	0.29 N • m (3 kgf • cm)

Use a proper-sized wrench.

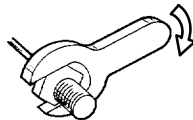

Fiber Connection and Disconnection

The E3X Amplifier has a push lock. Connect or disconnect the fibers to or from the E3X Amplifier using the following procedures:

1. Connection

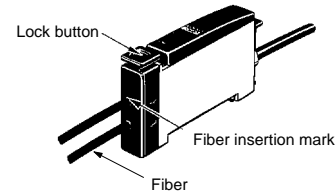

Insert the fibers into the E3X Amplifier and press the push lock until the Amplifier clicks to lock the fibers. The fibers will have insertion marks when they are cut with the E39-F4 (Fiber Cutter). The portion from the tips to the insertion mark should be inserted to the E3X.

2. Disconnection

Be sure to press the push lock again to unlock before pulling out the fiber, otherwise the fiber may be deteriorated.

Fiber Insertion

If the portion from the tip to the insertion mark of the fibers are not inserted into the Amplifier Unit, the sensing distance will be reduced.

2.2-mm-dia. Fiber

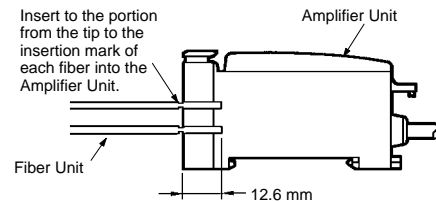

Thin Fiber with the E39-F9 Attachment

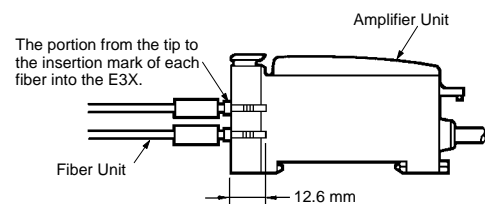

Fiber with Fixed Length

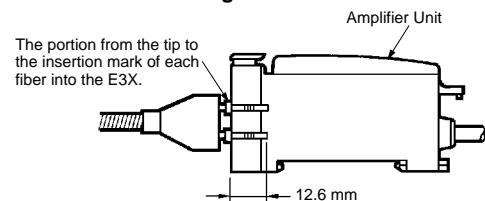

Cutting Fiber

Insert a fiber into the Fiber Cutter and determine the length of the fiber to be cut.

Press down the Fiber Cutter in a single stroke to cut the fiber.

An insertion mark can be placed on the fiber to serve as a reference when inserting the fiber into the Amplifier. Use the following procedure.

Insert the fiber all the way into the cutter and confirm that you can see it in the hole at the back of the cutter, then press firmly down on the cutter.

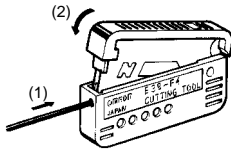

Insert the fiber into the Amplifier up to the insertion mark. Proper fiber performance will not be achieved unless the fiber is inserted all the way to the insertion mark. (This method is applicable to standard, 2.2-mm-diameter fibers only.)

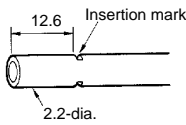

The cutting holes cannot be used twice. If the same hole is used twice, the cutting face of the fiber will be rough and the sensing distance will be reduced. Always use an unused hole.

Use either one of the two holes on the right (refer to the following figure) to cut a thin fiber as follows:

1. An attachment is temporarily fitted to a thin fiber before shipment.

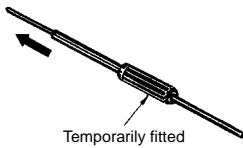

2. Secure the attachment after adjusting the position of it in the direction indicated by the arrow.



3. Insert the fiber into the E39-F4 to cut.

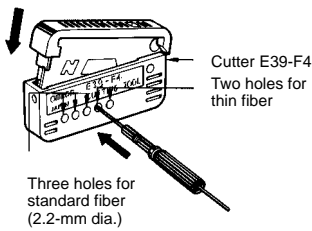

4. Finished state (proper cutting state)



Note: Insert the fiber in the direction indicated by the arrow.

Connection

Do not pull or press the Fiber Units. The Fiber Units have a withstand force of 9.8 N (1 kgf) or 29.4 N (3 kgf) max. (pay utmost attention because the fibers are thin).

Do not bend the Fiber Units beyond the permissible bending radius.

Do not bend the edge of the Fiber Units.

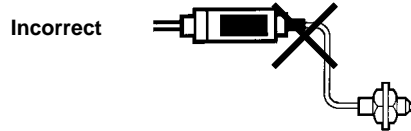
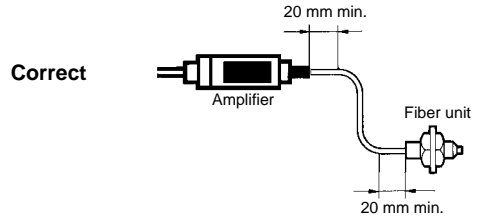

Do not apply excess force on the Fiber Units.

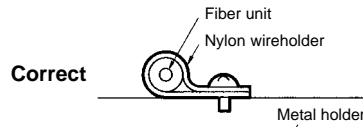

The Fiber Head could be broken by excessive vibration. To prevent this, the following is effective:

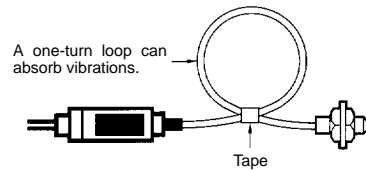

Bending Radius

E39-F11 Sleeve Bender

The bending radius of the stainless tube should be as large as possible. The smaller the bending radius becomes, the shorter the sensing distance will be.

Insert the tip of the stainless tube to the Sleeve Bender and bend the stainless tube slowly along the curve of the Sleeve Bender (refer to the figure).

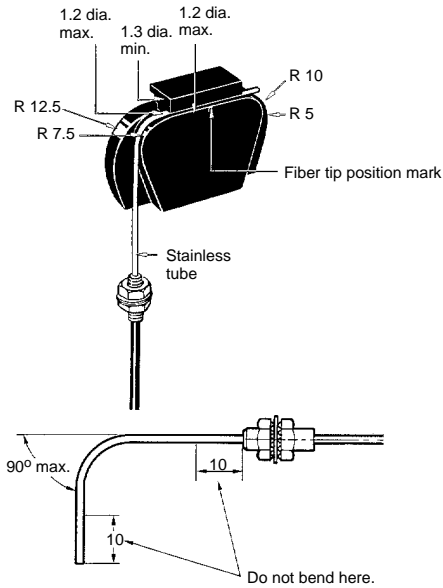

Handling

E32-D51/-T51 Heat-resisting Fiber

The bending radius of the fibers should be 35 mm min.

Connecting fibers via the E39-F10 Fiber Connector is not possible.

The withstand temperature of the Heat-Resisting Fibers is 150°C max. In continuous operation, the ambient temperature should be 130°C max.

E32-T14/-T51

If the sensor is ON because some object in front of the lenses reflects light, attach the black seals (sold together) to the lenses.

E32-T14/-G14

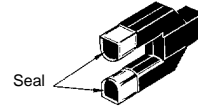

E32-L25 (A) Wafer Sensor

Insert the fiber with a white line into the light projection side of the Amplifier.

The tightening force of the sensor head is 0.75 N • m (8 kgf • cm). Avoid places where water could be sprayed onto the E32-L25(A).

E32-T16 Slit Seal (Attachment)

Peel the E32-T16 Slit Seal off the ground paper and affix the Slit Seal to the sensing face of the sensor so that the corners of the Slit Seal fit in with the corners of the sensing face. To sense an object at a distance of 30 cm max., a 0.5-mm wide Slit Seal must be used.

E32-T16 Sensing Head

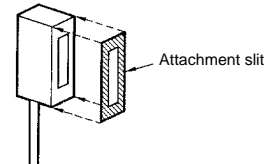

■ Amplifier Units

Mounting

Mounting

1. Mount the front part on the mounting bracket (sold together) or a DIN track.
2. Press the back part onto the mounting bracket or the DIN track.

Note: Do not mount the back part onto the mounting bracket or the DIN track first and then mount the front part on the mounting bracket or the DIN track, or the mounting strength of the Amplifier Unit may decrease.

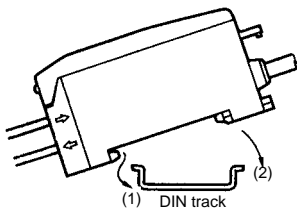

Dismounting

By pressing the Amplifier Unit in direction (3) and lifting the fiber insertion part in direction "4" as shown in the following, the Amplifier can be dismounted with ease.

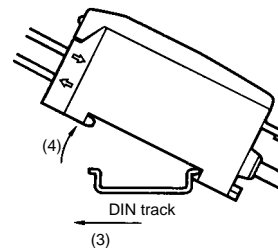

In the case of side mounting, attach the mounting bracket on the Amplifier first, and secure the Amplifier with M3 screws and washers. The diameter of the washers should be 6 mm max.

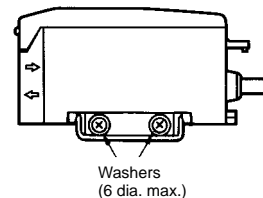

Minute Sensing Object

This datasheet shows typical examples for detecting minute objects. These typical examples are for reference use only, because these example operations were tested on Units sampled at random from a lot and the values described are average values. Do not assume that all Units ensure such operations.

Others

When power is OFF:

The moment power is turned OFF, the E3X could output a pulse signal which could affect the operation of the devices connected to it. This will happen more often if power is supplied to the E3X from an external power supply, thus affecting the connected timer and counter. Use a built-in power supply as much as possible to avoid this.

If power is supplied to a photoelectric sensor through a cord that is wired together with other power lines in the same duct, the cord will be influenced by the power lines and malfunctioning of the photoelectric sensor or damage could result. Wire the cord separately or use a sealed cord to supply power to the photoelectric sensor.

In the case of the cord is extended, use a wire with 0.3 mm² max. The total length of the cord should be 100 m max.

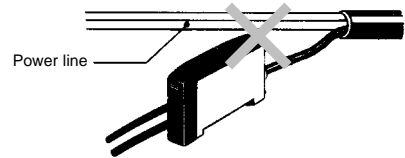

Power supply:

If a standard switching regulator is used as a power supply, the frame ground (FG) terminal and the ground (G) terminal must be grounded, or otherwise the E3X can malfunction, influenced by the switching noise of the power supply.

The supplied voltage must be within the rated voltage range. Unregulated full- or half-wave rectifiers must not be used as power supplies.

Do not use a hammer to hit the Amplifier when mounting or the Amplifier will lose watertightness.

■ Attachment Units

Applications

E39-F10 Fiber Connector

Use the following procedure (refer to the figure) to connect fibers via the Fiber Connector.

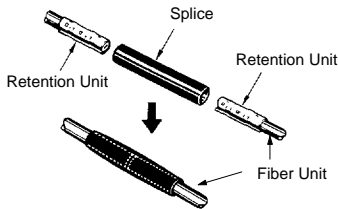

Each fiber should be as close as possible before they are connected.

Sensing distance will be reduced by approximately 25% when fibers are connected.

Only fibers with 2.2 mm dia. can be connected.

Protective Spiral Tube

Insert a fiber to the Protective Spiral Tube from the head connector side (screwed) of the tube.

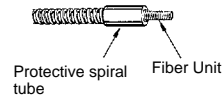

Push the fiber into the Protective Spiral Tube. The tube should be straight so that the fiber is not twisted when inserted. Then turn the end cap of the spiral tube.

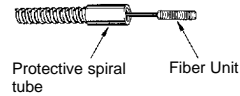

Secure the Protective Spiral Tube on a suitable place with the attached nut.

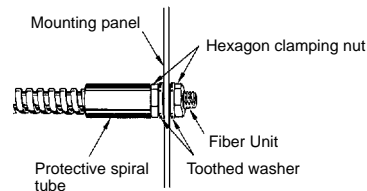

Use the attached saddle to secure the end cap of the Protective Spiral Tube. To secure the Protective Spiral Tube at a position other than the end cap, apply tape to the tube so that the portion becomes thicker in diameter.

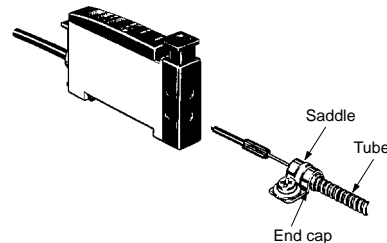

E39-F3A Reflective Unit Lens

When the E39-F3A is attached to the fiber, the E3X can sense the light reflected from the interior of the E39-F3A. If this happens, adjust the sensitivity of the E3X Amplifier with Sensitivity Adjustor.

Place a sensing object or white paper at the sensing distance set and adjust the insertion length of the Fiber Unit to the E39-F3A so that the light spot is as small as possible. Then fix the position of the Fiber Unit with the hexagonal wrench (attachment)

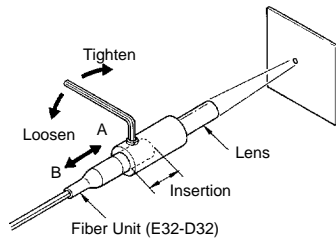

A: The focus is farther than the E39-F3A.

B: The focus is closer than the E39-F3A

■ E39-G3 Sensitivity Adjustor

1. Remove the cover of the E3X.
2. Attach the E39-G3 (refer to the figure).

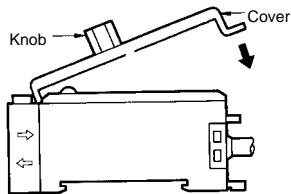

3. After the cover is attached to the case, turn the knob of the E39-F3A clockwise or counterclockwise once. To confirm that the knob has been set properly, turn the knob clockwise or counterclockwise until you hear a click (8 turns max. are necessary).

Note: E3X loses watertightness if E39-G3 is attached (the enclosure rating will be IEC60529 IP50).

■ Correct Use

E32-D82F

Sensitivity Adjustments

E3X-H11 High-sensitivity Model

Step	Sensing condition	Indicators	Adjustment
1		Green ON Red ON 	Locate the Sensor above the liquid surface. Set the sensitivity adjuster to Min. Slowly turn the sensitivity adjuster clockwise until the light reception indicator (i.e., the red indicator) is ON. This position is referred to as position A.
2		Green OFF Red OFF 	Dip the Sensor in the liquid. Set the sensitivity adjuster to Max. Slowly turn the sensitivity adjuster counterclockwise until the light reception indicator is OFF. This position is referred to as position B.
3	---	Green ON Red OFF 	Set the sensitivity adjuster in the middle point between positions A and B. This position is referred to as position C. Then check that the stability indicator (i.e., green indicator) is ON either when the Sensor is in the liquid or when it is above the liquid surface.

Liquid Level Sensing Position:

The liquid level sensing position is located 5.2±2 mm above the tip of the Teflon part. Refer to the illustration below.

The precise liquid level sensing position varies with the surface tension of the liquid and the wet condition of the sensing position.

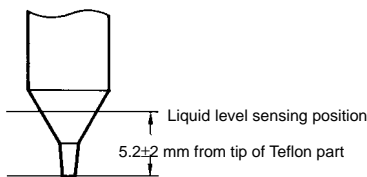

The Fiber Unit must be secured at sections that cannot be bent. Do not secure the Fiber Unit at sections that can be bent, otherwise precise liquid level detection may not be possible.

The side or bottom of the tank may affect the Fiber Unit and lower the performance of the Fiber Unit. In that case, locate the Fiber Unit far enough from the side or bottom of the tank or coat the side or bottom of the tank with black paint.

The operation of the Fiber Unit may not be stable in the following cases:

1. The cone part of the Sensor Head has gathered air foam.
2. The cone part of the Sensor Head has gathered dissolved substances.
3. The viscosity of the liquid is excessively high.

Some liquids, such as milky liquids, may not be detected.

Make sure that the tip of the Fiber Unit does not hit hard objects.

Operation may become unstable if the sensing head is scratched or deformed.

When the Units are to be used in a dangerous environment, install the Fiber Unit in a dangerous environment and the Amplifier Unit in a safe environment.

Part name	E32-D82F Sensor Head Teflon (see note)
Liquid	
Marine diesel oil, fuel oil, and heavy fuel oil	<input type="radio"/>
Aniline	<input type="radio"/>
Acrylonitrile	<input type="radio"/>
Asphalt	<input type="radio"/>
Acetone	<input type="radio"/>
Alcohol	<input type="radio"/>
Ammonia	<input type="radio"/>
Isocetane	<input type="radio"/>
Isobutyl alcohol	<input type="radio"/>
Isobutylmethyl ketone	<input type="radio"/>
Ethanol (Ethyl alcohol)	<input type="radio"/>
Ether	<input type="radio"/>
Ethylene glycol	<input type="radio"/>
Enamel	<input type="radio"/>
Ammonium chloride	<input type="radio"/>
Calcium chloride	<input type="radio"/>
Sodium chloride	<input type="radio"/>
Barium chloride	<input type="radio"/>
Chlorine	<input type="radio"/>
Gasoline	<input type="radio"/>
Glass material	<input type="radio"/>
Diluted hydrochloric acid	<input type="radio"/>
Diluted caustic soda	<input type="radio"/>
Diluted acetic acid	<input type="radio"/>
Diluted nitric acid	<input type="radio"/>
Diluted sulfuric acid	<input type="radio"/>
Citric acid	<input type="radio"/>
Glycerin	<input type="radio"/>
Cresol	<input type="radio"/>
Chloronaphthalene	<input type="radio"/>
Chloroform	<input type="radio"/>
Light oil	<input type="radio"/>
Mineral oil	<input type="radio"/>
Coal tar	<input type="radio"/>
Mucilage	<input type="radio"/>
Ethylene trichloride	<input type="radio"/>
Sodium dichromate	<input type="radio"/>
Barium sulfate	<input type="radio"/>
Silica-dispersed mineral oil	<input type="radio"/>
Silicone oil	<input type="radio"/>
Silicone resin (liquid)	<input type="radio"/>
Silicone varnish	<input type="radio"/>
Vegetable oil	<input type="radio"/>
Paint thinner	<input type="radio"/>
Barium hydroxide	<input type="radio"/>
Phenol	<input type="radio"/>
Turbine oil	<input type="radio"/>
Corn oil	<input type="radio"/>
Sodium carbonate	<input type="radio"/>
Turpentine oil	<input type="radio"/>
Natural gasoline	<input type="radio"/>
Kerosene	<input type="radio"/>
Trichloroethane	<input type="radio"/>
Trichloroethylene (Trichlene)	<input type="radio"/>
Toluene	<input type="radio"/>
Naphtha	<input type="radio"/>
Naphthalene	<input type="radio"/>
Lactic acid	<input type="radio"/>
Nitrobenzene	<input type="radio"/>
Concentrated hydrochloric acid	<input type="radio"/>
Concentrated caustic soda	<input type="radio"/>
Concentrated acetic acid	<input type="radio"/>
Concentrated nitric acid	<input type="radio"/>
Concentrated sulfuric acid	<input type="radio"/>
Concentrated phosphoric acid	<input type="radio"/>
Palm oil	<input type="radio"/>
Fluorine	<input type="radio"/>
Ferrosilicone	<input type="radio"/>
Freon 11	<input type="radio"/>
Propyl alcohol	<input type="radio"/>
Propylene glycol	<input type="radio"/>
Paint	<input type="radio"/>
Benzene	<input type="radio"/>
Boric acid	<input type="radio"/>
Pine oil	<input type="radio"/>
Methanol (Methyl alcohol)	<input type="radio"/>
Methyl violet	<input type="radio"/>
Water	<input type="radio"/>
Cotton seed oil	<input type="radio"/>
Alum	<input type="radio"/>
Carbon tetrachloride	<input type="radio"/>
Ammonium sulfate	<input type="radio"/>
Varnish	<input type="radio"/>
Material	

○: Applicable X: Not applicable

Note: Teflon is a registered trademark of the Dupont Company and the Mitsui Dupont Chemical Company for their fluoride resin.

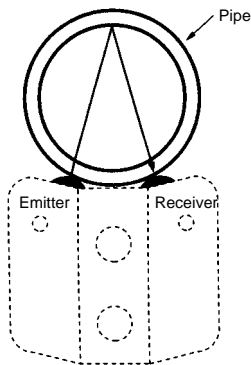
E32-L25T**Sensitivity Adjustments****Without Liquid**

Light reception without sensing liquid

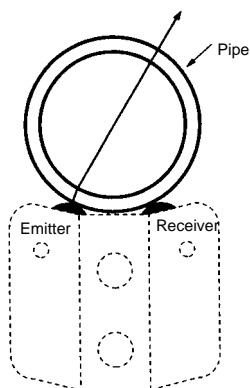
With Liquid

Set the sensitivity so that the light will be blocked by the sensing liquid.

Handling

Do not pull or press the Fiber Unit with any force exceeding $0.1 \text{ N} \cdot \text{m}$ ($1 \text{ kgf} \cdot \text{cm}$).

Do not bend the Fiber Unit beyond the permissible bending radius.

If the pipe is secured with a mounting band, make sure that the pipe will not be deformed.

The Fiber Unit may not operate properly if an opaque pipe is used.

The Fiber Unit may malfunction if the inner surface of the pipe gathers water drops or condensation.

The casing material uses a polycarbonate resin, which is soluble in alkaline, aromatic hydrocarbon, and chlorinated aromatic hydrocarbon solvents. Make sure that the casing is free from these materials.

If the background affects the Fiber Unit during operation, attach the reflection preventing sheet provided with the Fiber Unit. This sheet prevents the shifting of the Fiber Unit that may be caused by vibration.

ALL DIMENSIONS SHOWN ARE IN MILLIMETERS.

To convert millimeters into inches, multiply by 0.03937. To convert grams into ounces, multiply by 0.03527.

Cat. No. E275-E1-1 **In the interest of product improvement, specifications are subject to change without notice.**

OMRON Corporation

Industrial Sensors Division
Sensing Devices and Components Division H.Q.
28th Fl., Crystal Tower Bldg.,
1-2-27, Shiomi, Chuo-ku,
Osaka 540-6028 Japan
Phone: (81)6-949-6012 Fax: (81)6-949-6021

Printed in Japan
0698-1M (0698) a