

986-525 to 598  
Hanaywell GLS Series

## Contents

	page
General information	2
Standards	3
Degree of protection	4
How to read and understand the bar chart information	5
<b>Limit Switch</b>	
● EN 50041 GLA, standard metal body	6
GLF, standard metal body with one led	
GLH, standard metal body with two led's	
GLB, plug-in metal body	8
GLG, plug-in metal body with one led	
GLJ, plug-in metal body with two led's	
● EN 50047 GLC, miniature metal body	10
GLD miniature double insulated body (thermoplastic)	12
● EN 50047 compatible GLE three conduit metal body	14
<b>Additional lever types</b>	16
<b>Spare parts list</b>	17
<b>Proper application of Limit Switches</b>	19

# Standards

IEC 947-1 explains the general rules relating to **Low-voltage switchgear and controlgear**. The purpose of this standard is to harmonize as much as possible the product performance and test requirements for equipment where the rated voltage does not exceed 1,000 V a.c. or 1,500 V d.c.

IEC 947-5-1 is part 5 of the general rules which relates to **Control-circuit devices and switching elements**. Also within this part there is a section which considers **Special Requirements For Control Switches With Positive Opening Operation**. Any control switch which has this positive opening operation and conforms to these special requirements will be marked on the outside of the product with this symbol :



The Contact Element Form defines the configuration of the contacts and the number of contacts within the switch. e.g.

Form Za - both contact elements have the same polarity.

Form Zb - the two contact elements are electrically separated.

The **Utilization Category** defines the type of current carried (AC) Alternating current, (DC) Direct current and the typical application in which the switch is used e.g.

AC15 - Control of Electromagnetic Loads (less than 72VA)

DC13 - Control of electromagnets.

The contact rating **Designation** relates to the utilization categories and defines the conventional thermal current  $I_{th}$  (A), rated operational current  $I_e$  (A) at rated operational voltages  $U_e$  and the VA rating e.g.

A600 - The "A" denotes the maximum VA rating (AC) and the "600" denotes the maximum rated (AC) voltage.

Q300 - The "Q" denotes the maximum VA rating (DC) and the "300" denotes the maximum rated (DC) voltage.

These IEC standards have been adopted by CENELEC (The European Committee for Electrotechnical Standardization) and have been identified by replacing IEC with EN 60 e.g.

IEC 947-5-1 then becomes **EN 60947-5-1**.

CENELEC has defined the dimensions and characteristics of two types of limit switch in the standards **EN 50041** and **EN 50047**.

These standards relate to **Low voltage switchgear and controlgear for industrial use** and define the enclosure dimensions, the operating point for various head actuators, the earth terminal requirement, the terminal marking and the minimum degree of IP protection.

# Degree of protection

## IP Classification

The IEC 529 standard describes a system for classifying the degree of protection provided by the enclosures of electrical equipment.

The level of protection given by the enclosure is indicated by the IP code.

This code system uses the letters "IP" (International Protection) followed by up to four digits normally only the first two digits are used.

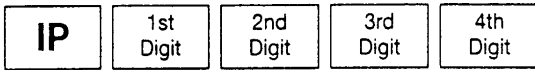

The first digit is numerical and indicates the level of protection within the enclosure against the ingress of solid foreign objects and access to hazardous parts by persons.

The second digit is also numerical and indicates the level of protection against the ingress of **WATER** into the enclosure.

The third digit is a letter and indicates a higher level of protection for persons against access to hazardous parts.

The fourth digit is also a letter and is used in exceptional cases for supplementary information.

If the first or second digit is not required to be specified, then it is replaced by the letter "X" ("XX" if both digits are not required).

While the tables below serve as a guide to the level of protection, Honeywell recommends that customers refer to the full official IEC specification for the exact definitions. If in doubt about the degree of protection required for a particular application, please consult your local Honeywell office.

### Note:

The IEC 529 standard does not relate to protection against rust, corrosion, icing or corrosive solvents (e.g. cutting fluids) and that product coded IP67 may not necessarily meet IP66 requirements.

First Digit	Protection against ingress of solid objects
IP	TEST
0	no protection
1	protected against solid objects with a diameter greater than 50 mm.
2	protected against solid objects with a diameter greater than 12 mm.
3	protected against solid objects with a diameter greater than 2.5 mm
4	protected against solid objects with a diameter greater than 1 mm
5	protected against dust-limited ingress (no harmful deposit)
6	totally protected against dust

Second Digit	Protection against ingress of water
IP	TEST
0	no protection
1	protected against vertically falling drops of water.
2	protected against vertically falling drops of water when the enclosure is tilted at an angle up to 15 degrees
3	protected against water sprayed at an angle of 60 degrees from the vertical
4	protected against splashing water from all directions - limited ingress (no harmful effects)
5	protected against low pressure jets of water from all directions - limited ingress permitted
6	protected against powerful jets of water from all directions - limited ingress permitted
7	protected against the effects of temporary immersion in water
8	protected against the effects of continuous immersion in water

## NEMA Classification (USA)

NEMA (National Electrical Manufacturer's Association) prepares standards which define a product, process or procedure with reference to one or more of the following: nomenclature, composition, construction, dimensions, tolerances, safety, operating characteristics, performance, quality, electrical rating, testing and the service for which designed.

This standard provides degrees of protection for Enclosures for Electrical Equipment (1000 Volts Maximum) similar to that of the IEC 529 standard. The reference standard herein reflects the latest data in the NEMA Standards Publication when this information pack went to print.

### Non-hazardous locations

**Type 1 enclosures** are intended for indoor use primarily to provide a degree of protection against contact with the enclosed equipment.

**Type 3 enclosures** are intended for outdoor use primarily to provide a degree of protection against windblown dust, rain, sleet, and external ice formation.

**Type 4 enclosures** are intended for indoor or outdoor use primarily to provide a degree of protection against windblown dust and rain, splashing water, and hose-directed water.

**Type 4X enclosures** are intended for indoor or outdoor use primarily to provide a degree of protection against corrosion, windblown dust and rain, spashing water, and hose-directed water.

**Type 6 enclosures** are intended for indoor or outdoor use primarily to provide a degree of protection against the entry of water during occasional temporary submersion at a limited depth.

**Type 6P enclosures** are intended for indoor or outdoor use primarily to provide a degree of protection against the entry of water during prolonged submersion at a limited depth.

**Type 12 enclosures** are intended for indoor use primarily to provide a degree of protection against dust, falling dirt, and dripping noncorrosive liquids.

**Type 13 enclosures** are intended for indoor use primarily to provide a degree of protection against dust, spraying water, oil and noncorrosive coolant.

Note: Enclosures are based, in general, on the broad definitions outlined in NEMA Standards. Therefore, it will be necessary to ascertain that a particular enclosure will be adequate when exposed to the specific conditions that might exist in intended applications. Except as might otherwise be noted, all references to products relative to NEMA enclosure type are based on Honeywell evaluation and Underwriter's Laboratory (UL) tested.

This NEMA Standards Publication does test for environmental conditions such as corrosion, rust, icing, oil, and coolants. The IEC 529 does not, and does not specify degree of protection against mechanical damage of equipment. For this reason, and because the tests and evaluations for other characteristics are not identical, the IEC Enclosure Classification Designations cannot be exactly equated with NEMA Enclosure Type Numbers.

# How to read and understand the bar chart information

The following example relates to a unit which has a snap action basic and which has a roller pin plunger actuator i.e. GLCB01C.

When reading these bar charts follow these rules :

1. Check what type of actuator was used to test the product, this is on the drawings which show the head style available. It will be one of two types :
  - a) Vertical travel plunger
  - b) Linear cam travel
2. Start reading from top left of figure B, at the arrow labeled "A".
3. Follow the black arrows and the black strip on the chart. The black strip indicates that there is a circuit between the terminals whose numbers are shown on the left and when white there is no circuit.

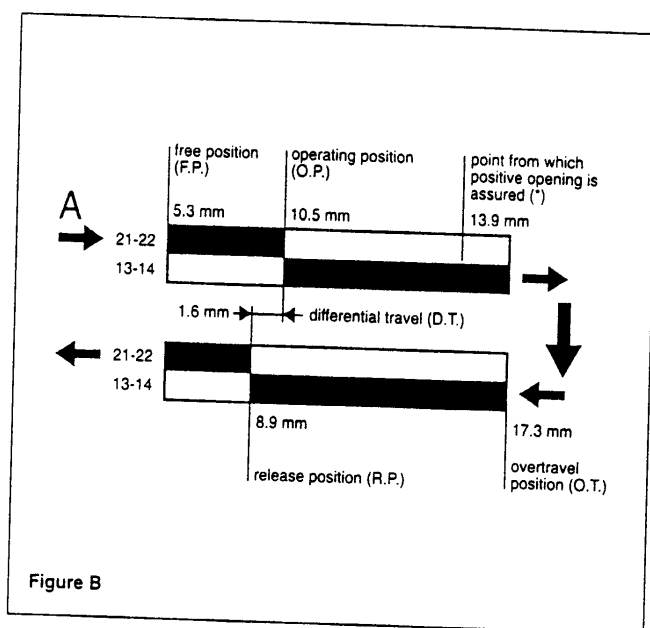
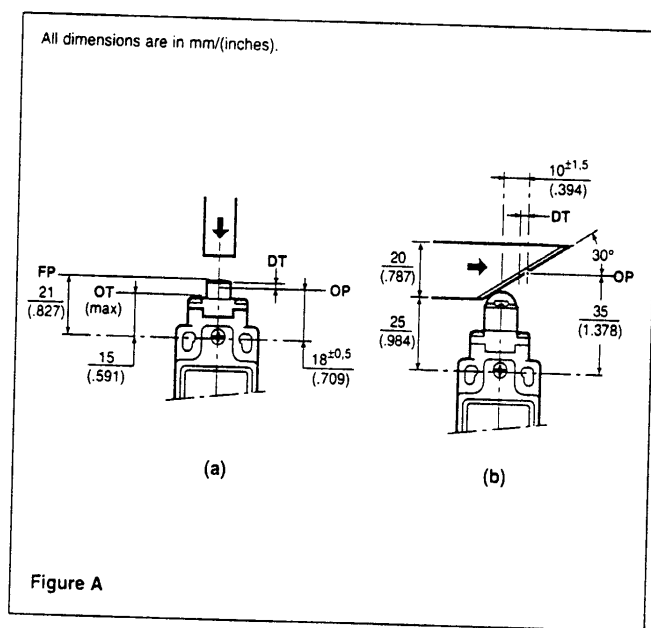

Look at Figures A and B as examples. Actuator type used for test is the linear Cam travel type (b) shown left. The start point is at the arrow marked "A" (See fig. B). This shows the free position to be 5.3 mm from the vertical centre line of the unit. At this stage there is a circuit between the terminals 21-22 but no circuit between terminals 13-14. The unit can be actuated until it reaches the operating position which is 10.5 mm from the centre line - a travel distance of  $10.5 - 5.3 = 5.2$  mm. At this point the circuit arrangement changes - no circuit between 21-22 but making a circuit between 13-14. If, however, the contacts of terminals 21-22 weld together and will not separate, a mechanical safety feature will take effect if the switch is travelled past the point from which positive opening is assured, 13.9 mm. As the switch returns it reaches the release position at 8.9 mm from the centre line. The circuit will change back to the original state and the difference between the operating position and the release position gives what is known as the differential travel i.e.  $10.5 - 8.9 = 1.6$  mm. The asterisk (\*) indicates the point from which the positive opening is assured.

# GLA - Metal Standard GLF - (w/1LED) 12...250Vac/dc GLH - (w/2LED) 18...30Vdc EN 50041

## Technical Data

Mechanical life	up to 15 million operations
Degree of protection	IP67 NEMA/UL type 1, 4, 12, 13
Temperature range	Operating : -25°C to +85°C -13°F to +185°F Storage : -40°C to +85°C -40°F to +185°F
Approvals	IEC 947-5-1 EN60947-5-1 AC15 A300/A600 DC13 Q300 UL & CSA
Vibration	10 g conforming to IEC 68-2-6
Shock	50 g conforming to IEC 68-2-27 Terminal marking to EN 50013

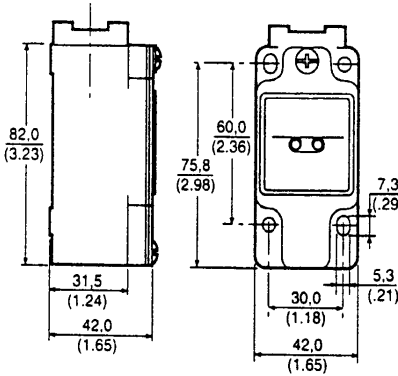

## Conduit Thread

Std =	<b>A</b>	<b>A</b> = 1/2" NPT
(w/1LED) =	<b>F</b>	<b>B</b> = PG 13,5
(w/2LED) =	<b>H</b>	<b>C</b> = 20 mm
		<b>D</b> = PF 1/2
Ordering :	<b>X</b>	<b>X</b>
	<b>GL</b>	<b>XX</b>

Example : GLA B 01 B    GLF B 01 B    GLH B 01 B

## Snap-Action Contacts

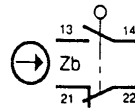

█ Circuit closed  
\* Positive opening to IEC 947-5-1-3

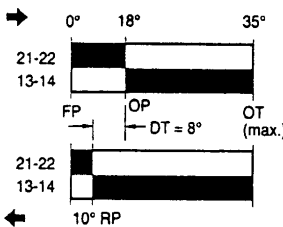
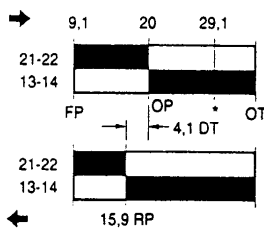
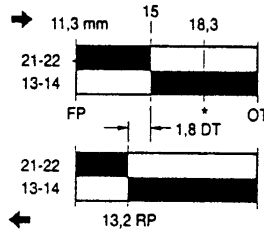
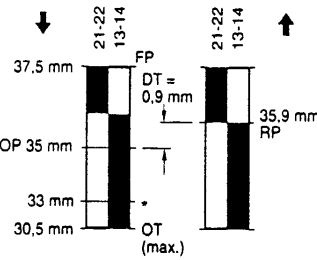
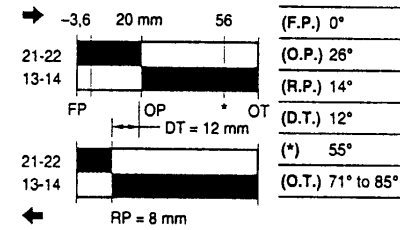

## Slow-Action Contacts BREAK BEFORE MAKE

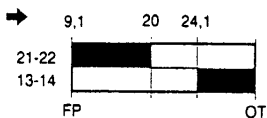
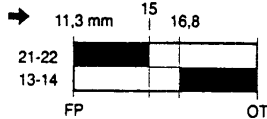
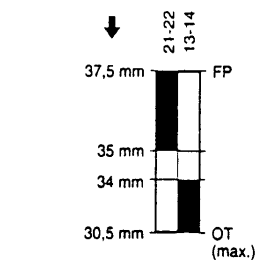
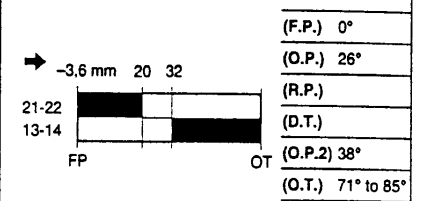
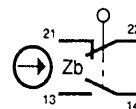

\* Point from which the positive opening is assured

**01**

**03**

**XX**

**Slow-Action Contacts**  
*MAKE BEFORE BREAK*

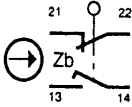

**Snap-Action Contacts**  
*DOUBLE POLE*

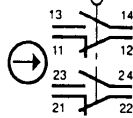

**Actuator Types**

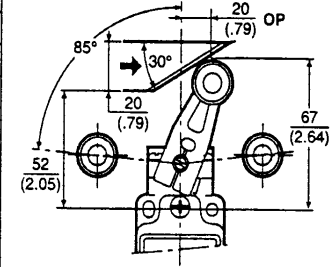
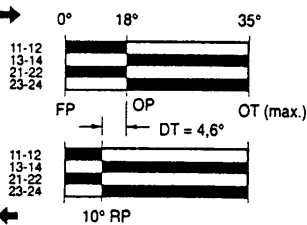
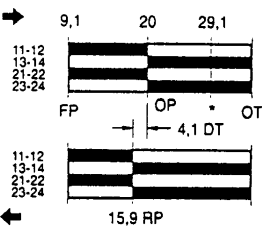
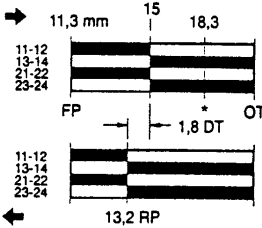
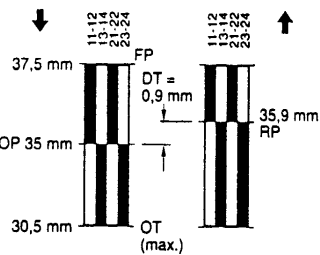
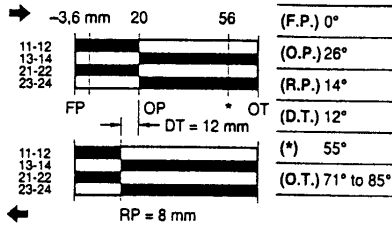
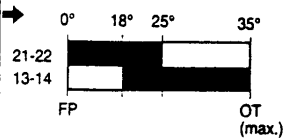
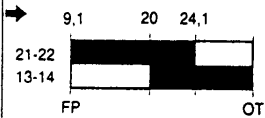
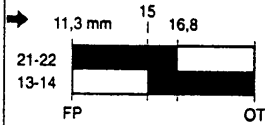
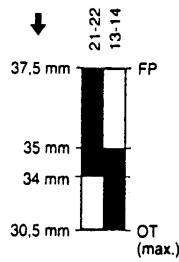
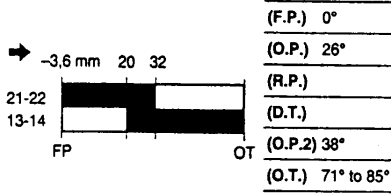

**A1B**  
Additional levers available (see page 16)

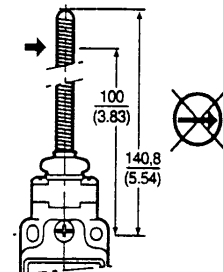
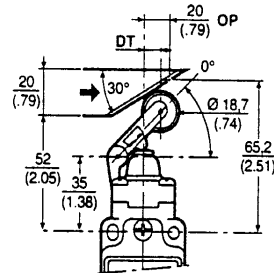
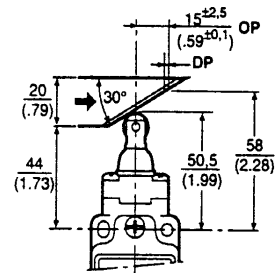
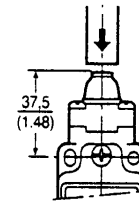

**B**

**C**

**D**

**E7B**

(GLA) (GLF, GLH)

**04**

**20** or **24**

**XXX**

# GLB - Metal Plug-in GLG - (w/1LED) 12...250Vac/dc GLJ - (w/2LED) 18...30Vdc EN 50041

## Technical Data

Mechanical life	up to 15 million operations
Degree of protection	IP67 NEMA/UL type 1, 4, 12, 13
Temperature range	Operating : -25°C to +85°C -13°F to +185°F Storage : -40°C to +85°C -40°F to +185°F
Approvals	IEC 947-5-1 EN60947-5-1 AC15 A300/A600 DC13 Q300 UL & CSA
Vibration	10 g conforming to IEC 68-2-6
Shock	50 g conforming to IEC 68-2-27 Terminal marking to EN 50013

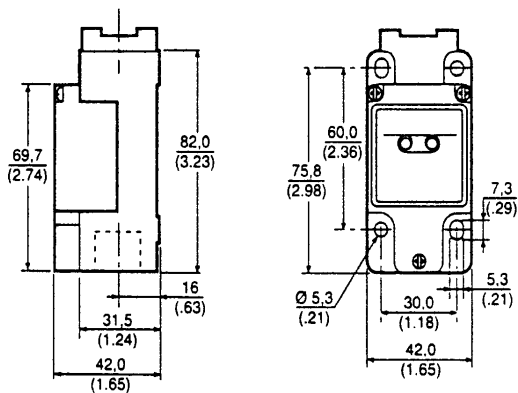

## Conduit Thread

Plug-in = <b>B</b>	<b>A</b> = 1/2" NPT
(w/1LED) = <b>G</b>	<b>B</b> = PG 13,5
(w/2LED) = <b>J</b>	<b>C</b> = 20 mm
	<b>D</b> = PF 1/2
↓	↓
<b>X</b>	<b>X</b>

Ordering :

**GL**

**X**

**X**

## Snap-Action Contacts

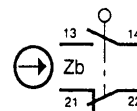

█ Circuit closed  
\* Positive opening to IEC 947-5-1-3

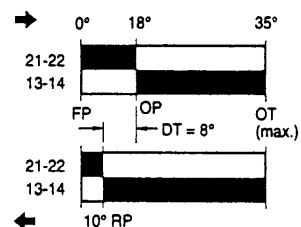
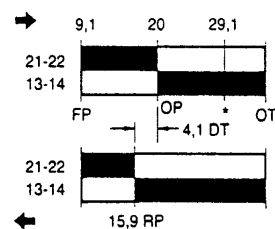
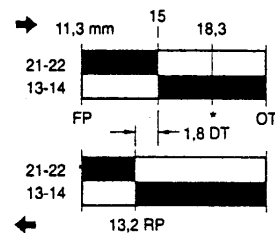
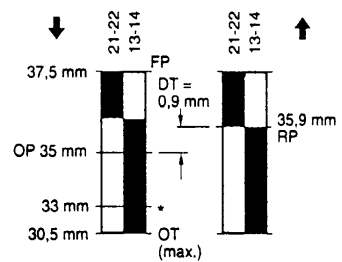
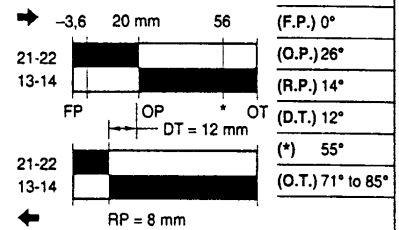

\* Point from which the positive opening is assured

(GLB only)

**02**

### Snap-Action Contacts

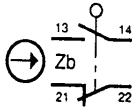

### Snap-Action Contacts

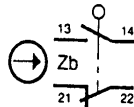

### Actuator Types

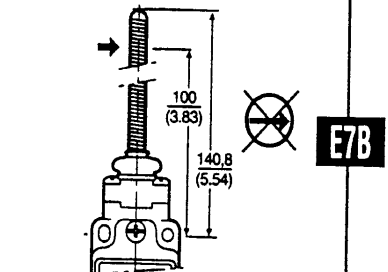
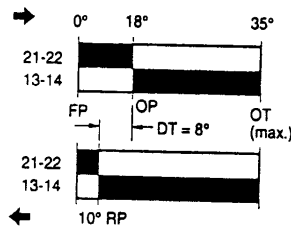
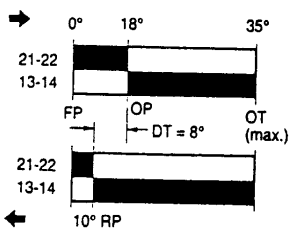
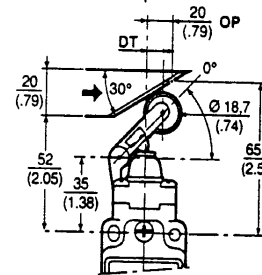
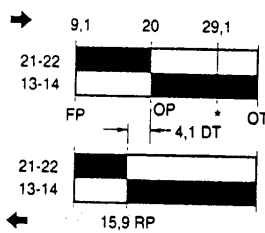
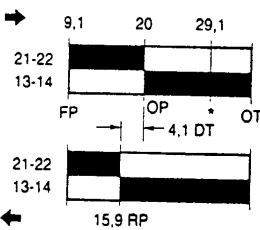
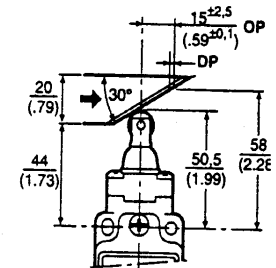
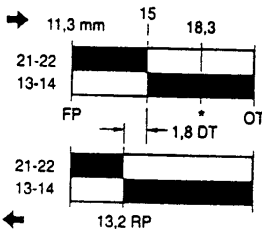
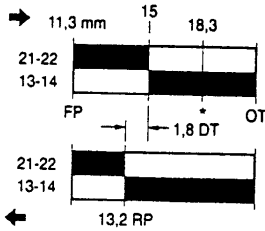
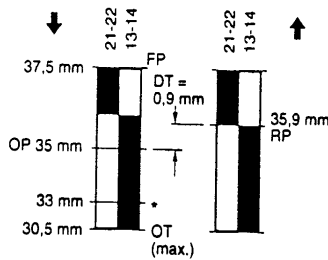
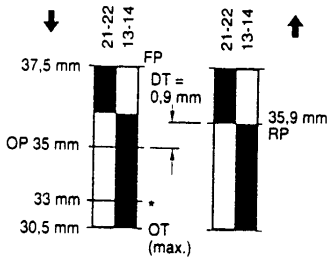
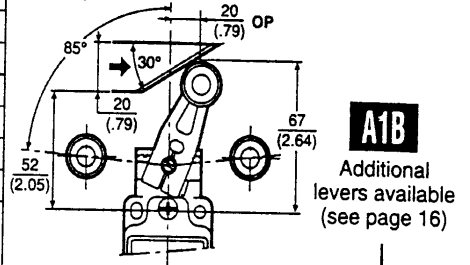
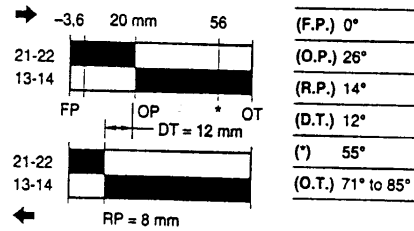
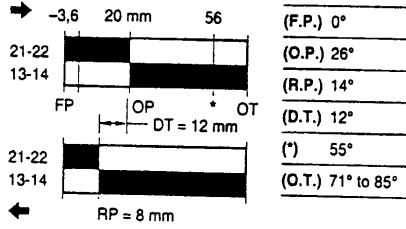

(GLG only)

**12**

**XX**

(GLJ only)

**13**

**XXX**



# GLC EN 50047 Metal standard

## Technical Data

Mechanical life	up to 15 million operations
Degree of protection	IP66 NEMA/UL type 1, 4, 12, 13
Temperature range	Operating : -25°C to +85°C -13°F to +185°F Storage : -40°C to +85°C -40°F to +185°F
Approvals	IEC 947-5-1 EN60947-5-1 AC15 A300 DC13 Q300 UL & CSA
Vibration	10 g conforming to IEC 68-2-6
Shock	50 g conforming to IEC 68-2-27 Terminal marking to EN 50013

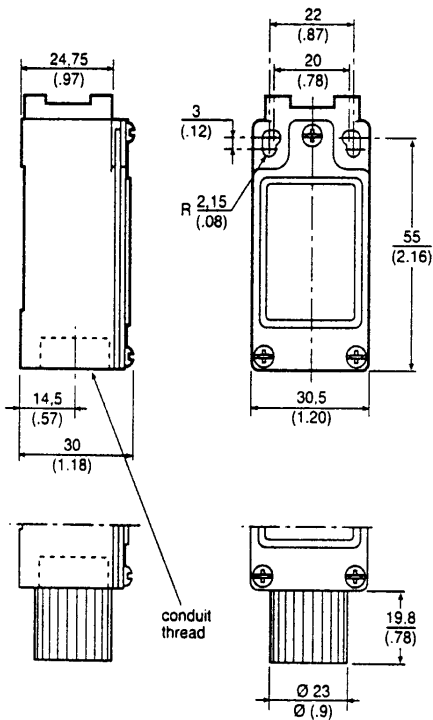

### Conduit Thread

**A** = 1/2" NPT adapter

**B** = PG 13,5

**C** = 20 mm

**D** = PF 1/2

**X**

Ordering :

**GLC**

Example : GLC B 01 B

## Snap-Action Contacts

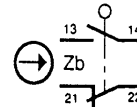

Circuit closed

\* Positive opening to IEC 947-5-1-3

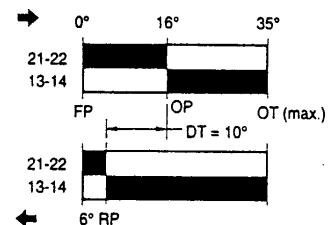
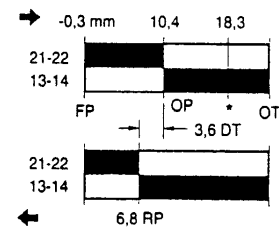
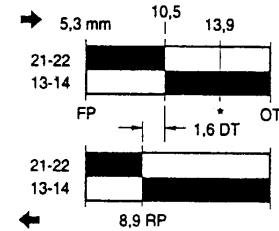
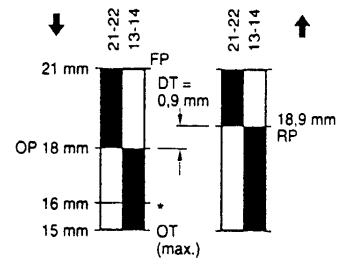
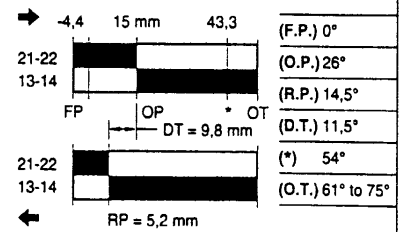

\* Point from which the positive opening is assured

**01**

**Slow-Action Contacts**  
BREAK BEFORE MAKE

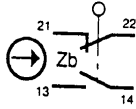

**Slow-Action Contacts**  
MAKE BEFORE BREAK

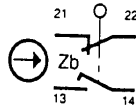

**Actuator Types**

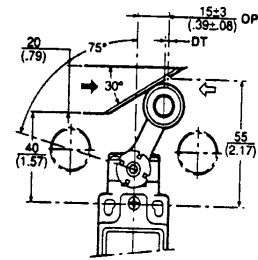
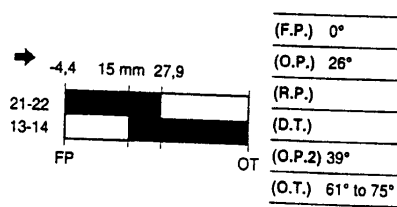
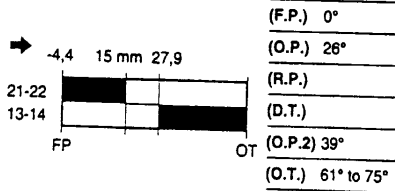

**A1B**  
Additional levers available (see page 16)

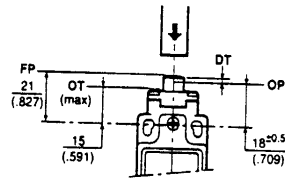
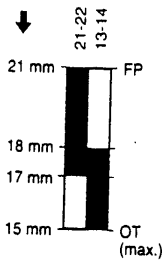
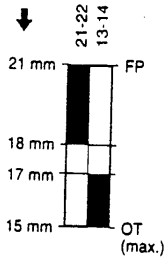

**B**

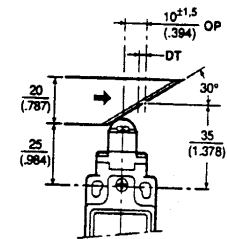
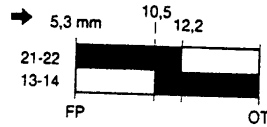
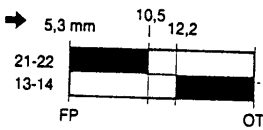

**C**

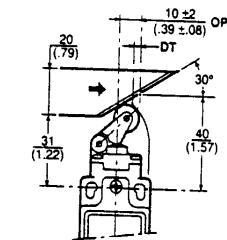
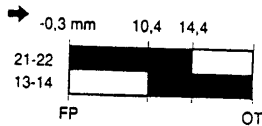
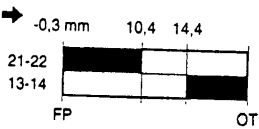

**D**

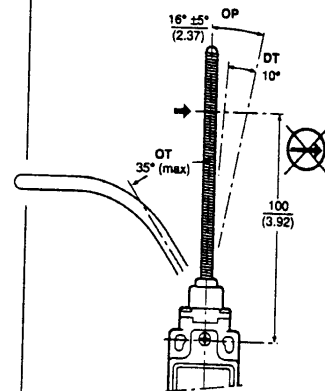
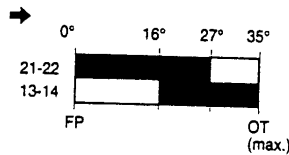
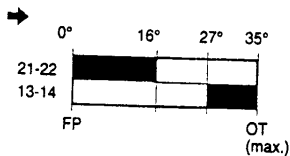

**E7B**

**03**

**04**

**XX**

**XXX**

# GLD EN 50047 Double insulated standard

## Technical Data

Mechanical life	up to 15 million operations
Degree of protection	IP66 NEMA/UL type 1, 12, 13
Temperature range	Operating : -25°C to +85°C -13°F to +185°F Storage : -40°C to +85°C -40°F to +185°F
Approvals	IEC 947-5-1 EN60947-5-1 AC15 A600 DC13 Q300 UL & CSA
Vibration	10 g conforming to IEC 68-2-6
Shock	50 g conforming to IEC 68-2-27 Terminal marking to EN 50013

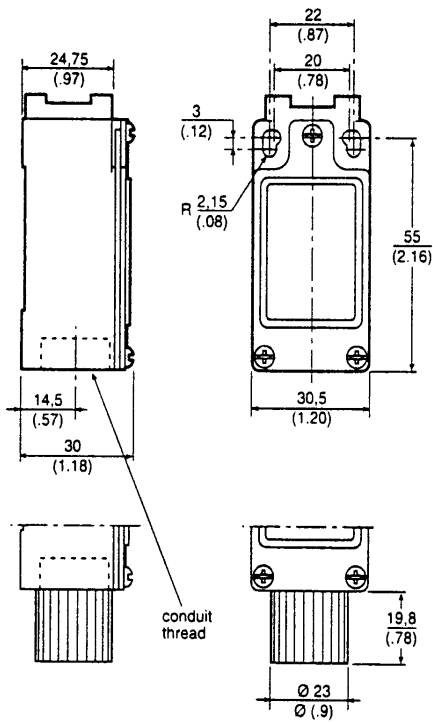

### Conduit Thread

- A** = 1/2" NPT adapter
- B** = PG 13,5
- C** = 20 mm adapter
- D** = PF 1/2 adapter

Ordering :

**GLD**

**X**

Example : GLD B 01 B

## Snap-Action Contacts

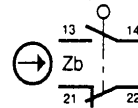

■ Circuit closed  
\* Positive opening to IEC 947-5-1-3

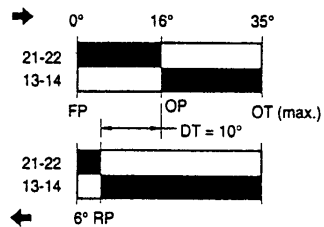
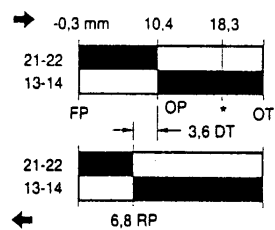
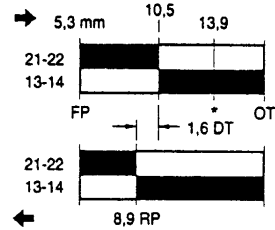
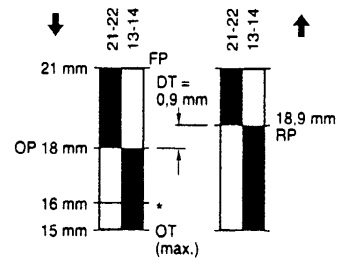
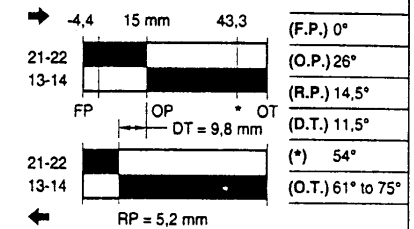

\* Point from which the positive opening is assured

**01**

### Slow-Action Contacts

*BREAK BEFORE MAKE*

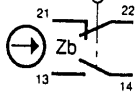

### Slow-Action Contacts

*MAKE BEFORE BREAK*

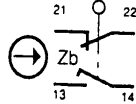

### Actuator Types

→ 4,4 15 mm 27,9



(F.P.)	0°
(O.P.)	26°
(R.P.)	
(D.T.)	
(O.P.2)	39°
(O.T.)	61° to 75°

→ 4,4 15 mm 27,9

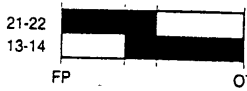

(F.P.)	0°
(O.P.)	26°
(R.P.)	
(D.T.)	
(O.P.2)	39°
(O.T.)	61° to 75°

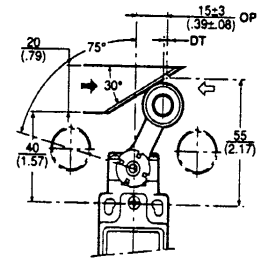
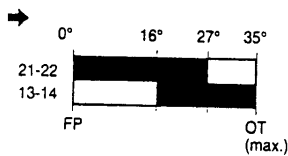
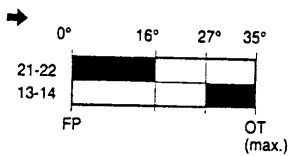
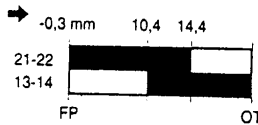
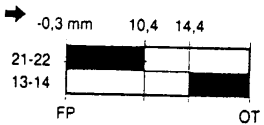
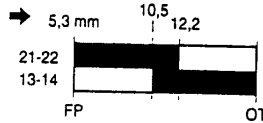
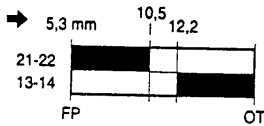
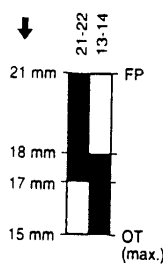
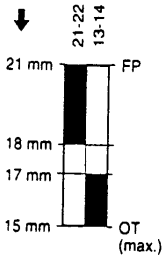

**A1B**

Additional levers available (see page 16)

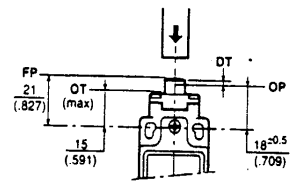

**B**

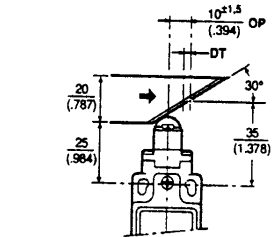

**C**

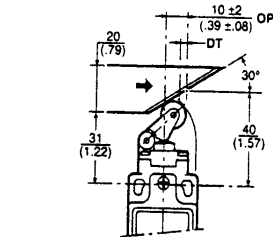

**D**

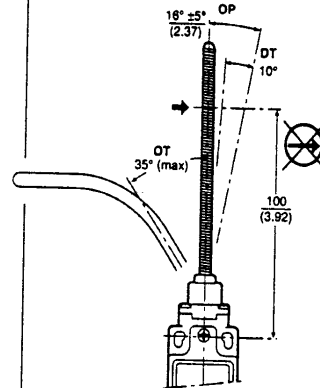

**E7B**

**03**

**04**

**XX**

**XXX**

# GLE EN 50047 Compatible 3 Conduit Metal standard

## Technical Data

Mechanical life up to 15 million operations

Degree of protection IP66  
NEMA/UL type 1, 4, 12, 13

Temperature range Operating :  
-25°C to +85°C  
-13°F to +185°F  
Storage :  
-40°C to +85°C  
-40°F to +185°F

Approvals IEC 947-5-1  
EN60947-5-1  
AC15 A300  
DC13 Q300  
UL & CSA

Vibration 10 g conforming to IEC 68-2-6

Shock 50 g conforming to IEC 68-2-27  
Terminal marking to EN 50013

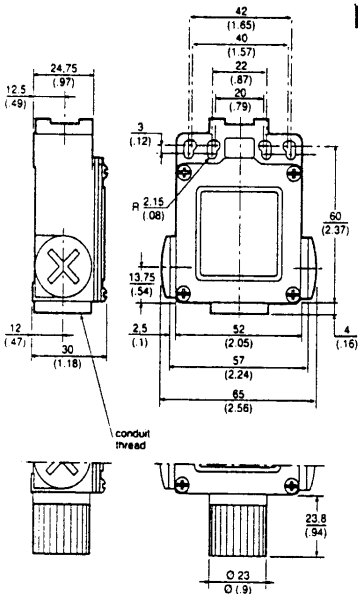

### Conduit Thread

**A** = 1/2" NPT adapter

**B** = PG 13,5

**C** = 20 mm

**D** = PF 1/2

Ordering :

**GLE**

**X**

Example : GLE B 01 B

## Snap-Action Contacts

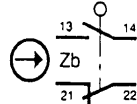

Circuit closed  
\* Positive opening to IEC 947-5-1-3

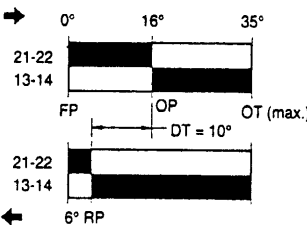
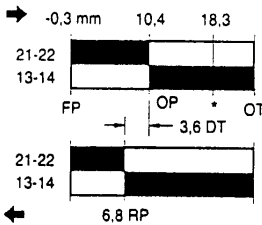
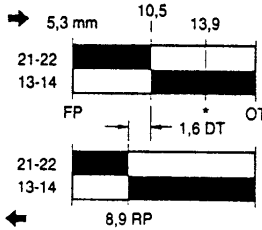
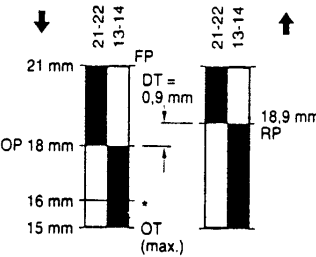
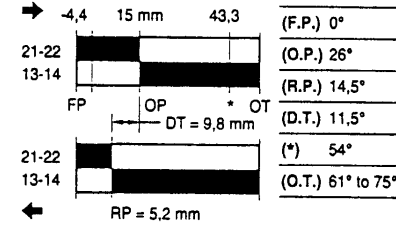

## Slow-Action Contacts BREAK BEFORE MAKE

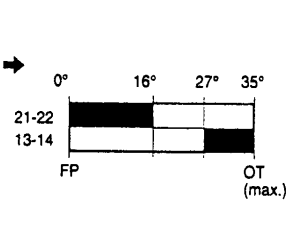
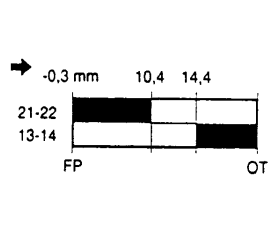
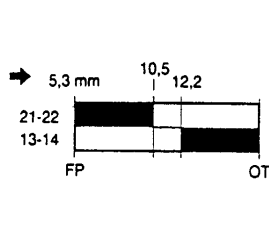
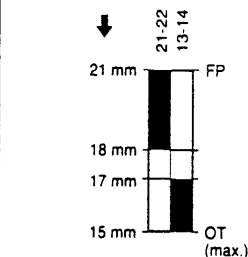
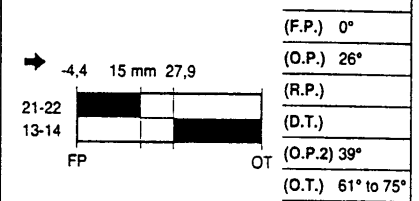
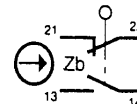

\* Point from which the positive opening is assured

**01**

**03**

**XX**

**Slow-Action Contacts**  
*MAKE BEFORE BREAK*

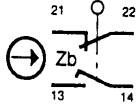

**Snap-Action Contacts**  
*DOUBLE POLE*

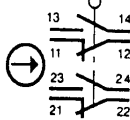

**Actuator Types**

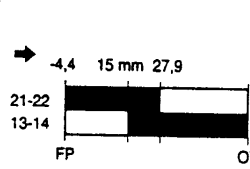

- (F.P.) 0°
- (O.P.) 26°
- (R.P.)
- (D.T.)
- (O.P.2) 39°
- (O.T.) 61° to 75°

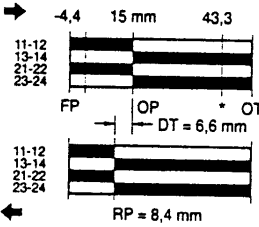
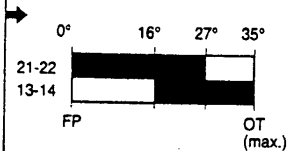
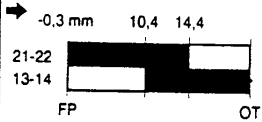
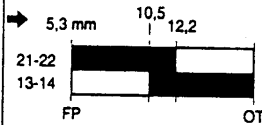
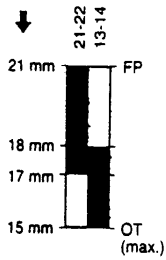

- (F.P.) 0°
- (O.P.) 26°
- (R.P.) 18°
- (D.T.) 8°
- (\*) 54°
- (O.T.) 61° to 75°

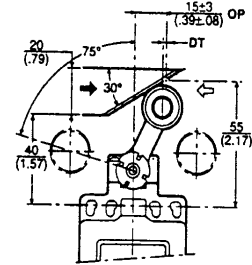
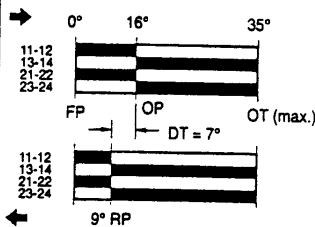
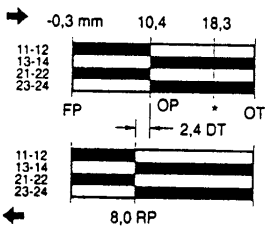
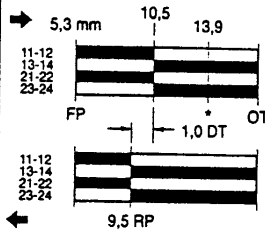
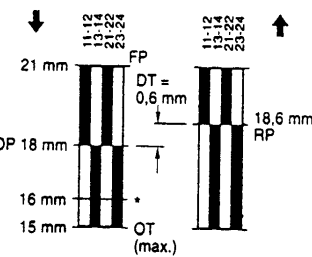

**A1B**  
Additional levers available (see page 16)

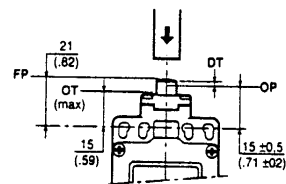

**B**

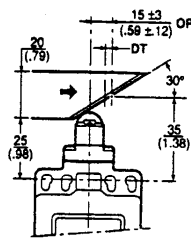

**C**

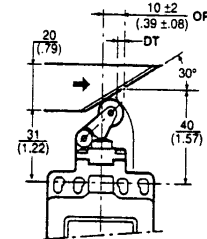

**D**

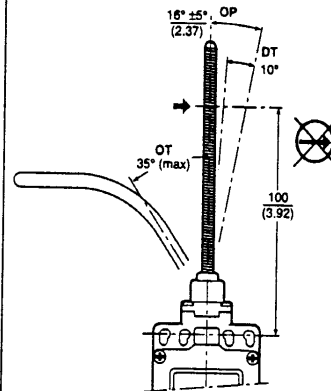

**E7B**

# Additional Lever Types

For use with all Side Rotary Head Styles.

Figure 1 illustrates Miniature Din lever types conforming to EN 50047 while

Figure 2 illustrates Standard Din lever types which conform to EN 50041.

All dimensions are in mm/(inches).

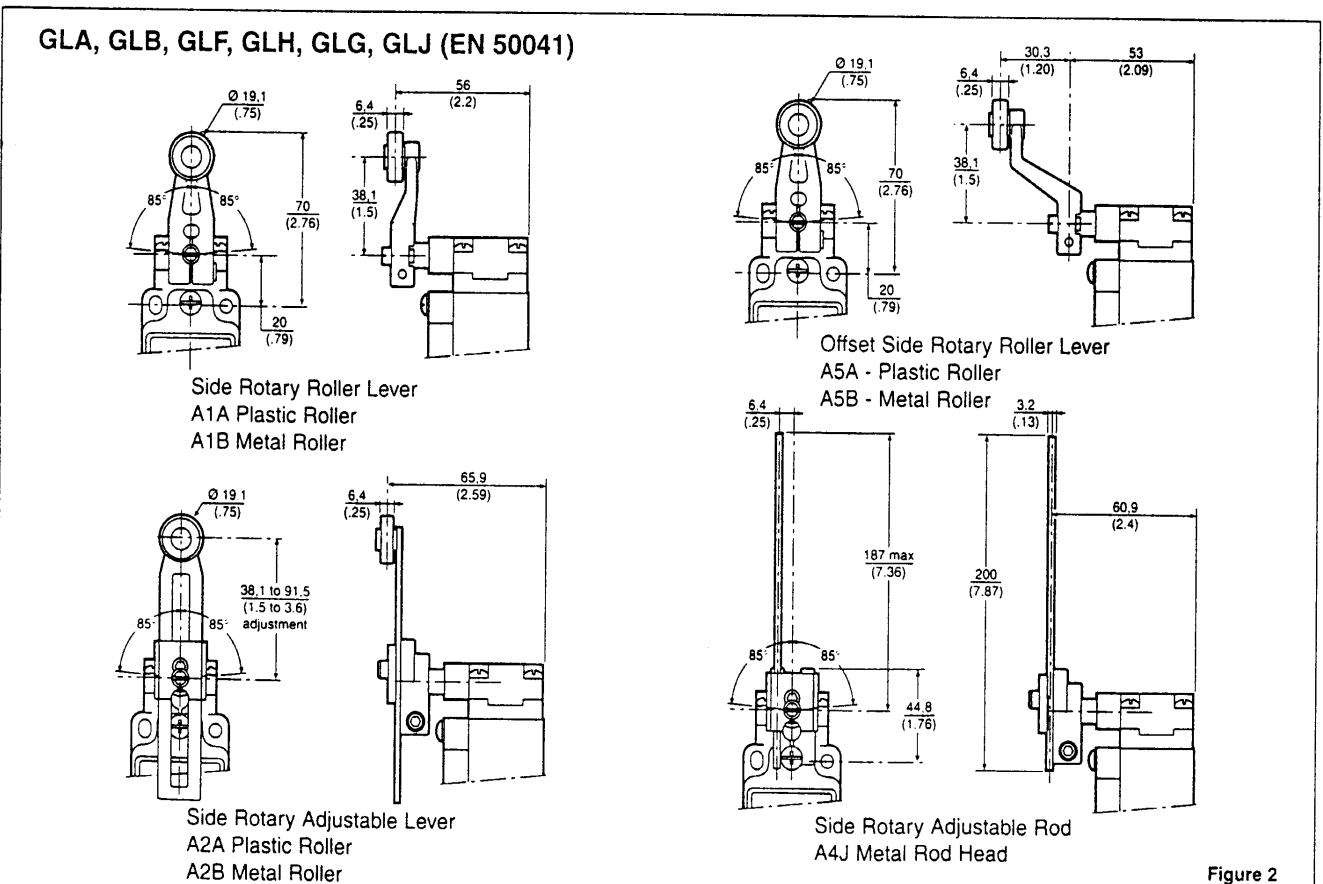
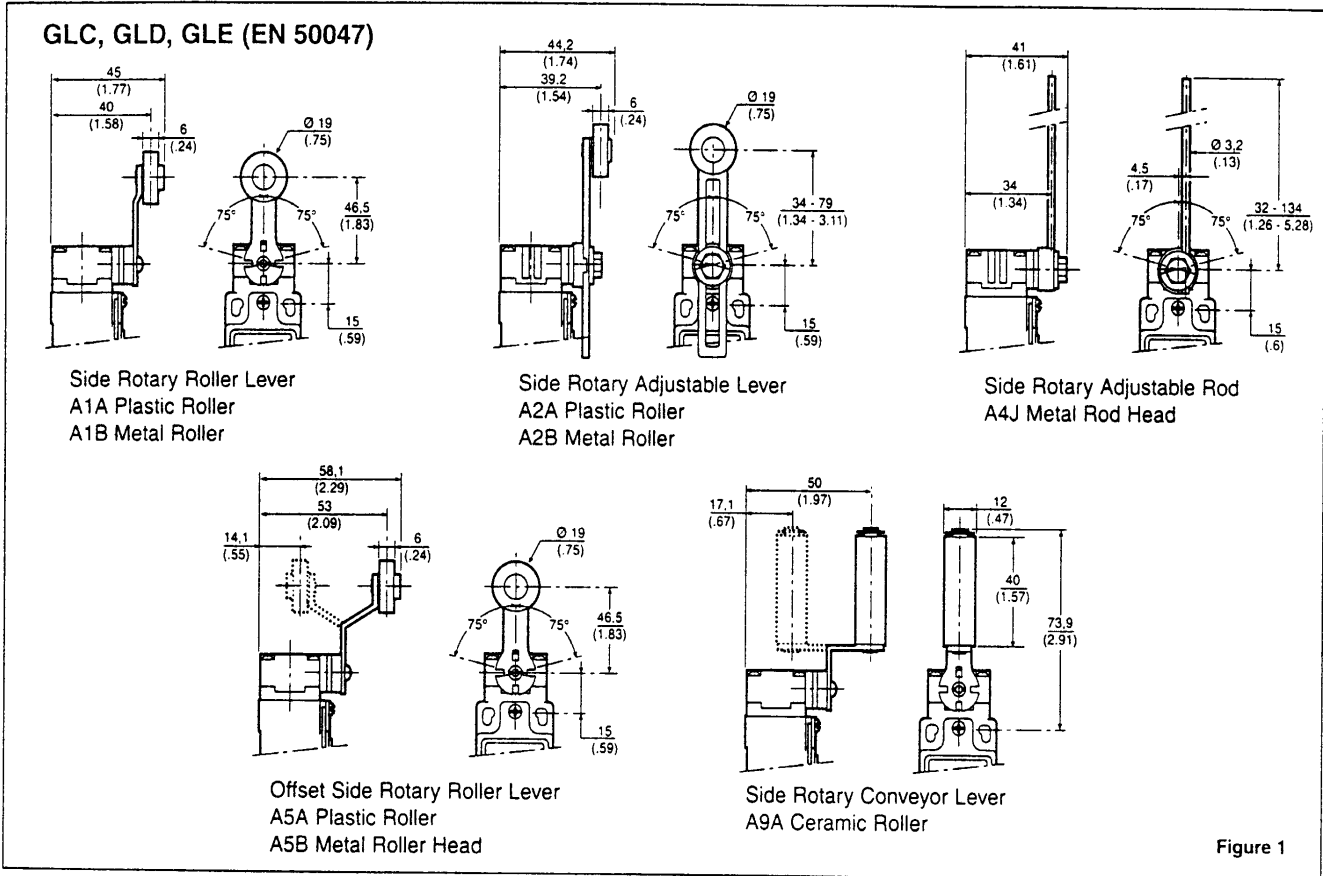

# Spare Parts for the GLS Series

To order spare parts for your particular GLS simply use the GLS number on the front of the switch to identify the construction used and therefore the spare part you need.

For Example : The part No : GLAB01E7B

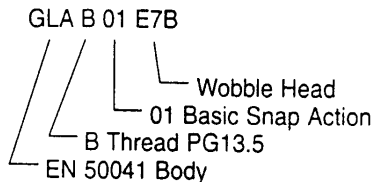

For Example : The part No : GLDC04A1B

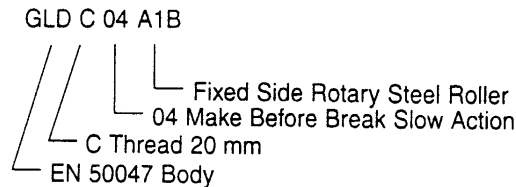

From the tables below it is possible to obtain replacement Basic Switches, Heads, Actuators, Levers and LED Assemblies.

**Note :** Spare parts should only be used to replace parts on existing listings. Honeywell accepts no liability for parts used in combinations not recognised by Honeywell as valid listings.

## Basic Switches

Body Type	01	Basic 02	Switch 03	04	12	13	20	24
GLA	GLZ301		GLZ303	GLZ304			GLZ320	
GLB		GLZ302						
GLC	GLZ301		GLZ303	GLZ304				
GLD	GLZ301		GLZ303	GLZ304				
GLE	GLZ301		GLZ303	GLZ304				GLZ324
GLF	GLZ301		GLZ303	GLZ304				
GLG					GLZ312			
GLH	GLZ301		GLZ303	GLZ304				
GLJ						GLZ313		

**Note 1 :** for these spares you will receive the front of the body with no head. To replace the faulty switch/LED assembly remove the old body and old head. Retrofit the head onto the replacement and plug in the spare switch/LED assembly into the old base.

## Heads

Body Type	A	Head B	Types C	D	E7A	E7B	E7D	K8A	K8B	K8C
GLA	GLZ1AA	GLZ1AB	GLZ1AC	GLZ1AD	GLZ1AE7A	GLZ1AE7B	GLZ1AE7D	GLZ1AK8A	GLZ1AK8B	GLZ1AK8C
GLB	GLZ1AA	GLZ1AB	GLZ1AC	GLZ1AD	GLZ1AE7A	GLZ1AE7B	GLZ1AE7D	GLZ1AK8A	GLZ1AK8B	GLZ1AK8C
GLC	N/A	N/A	N/A	N/A	N/A	N/A	N/A	N/A	N/A	N/A
GLD	N/A	N/A	N/A	N/A	N/A	N/A	N/A	N/A	N/A	N/A
GLE	N/A	N/A	N/A	N/A	N/A	N/A	N/A	N/A	N/A	N/A
GLF	GLZ1AA	GLZ1AB	GLZ1AC	GLZ1AD	GLZ1AE7A	GLZ1AE7B	GLZ1AE7D	GLZ1AK8A	GLZ1AK8B	GLZ1AK8C
GLG	GLZ1AA	GLZ1AB	GLZ1AC	GLZ1AD	GLZ1AE7A	GLZ1AE7B	GLZ1AE7D	GLZ1AK8A	GLZ1AK8B	GLZ1AK8C
GLH	GLZ1AA	GLZ1AB	GLZ1AC	GLZ1AD	GLZ1AE7A	GLZ1AE7B	GLZ1AE7D	GLZ1AK8A	GLZ1AK8B	GLZ1AK8C
GLJ	GLZ1AA	GLZ1AB	GLZ1AC	GLZ1AD	GLZ1AE7A	GLZ1AE7B	GLZ1AE7D	GLZ1AK8A	GLZ1AK8B	GLZ1AK8C

## Levers / Actuators (For GLZ1AA Head Type Only (side rotary))

Body Type	1A	Lever 1B	Actuator 2A	Type 2B	4J	5B
GLA	GLZ51A	GLZ51B	GLZ52A	GLZ52B	GLZ54J	GLZ55B
GLB	GLZ51A	GLZ51B	GLZ52A	GLZ52B	GLZ54J	GLZ55B
GLC	N/A	N/A	N/A	N/A	N/A	N/A
GLD	N/A	N/A	N/A	N/A	N/A	N/A
GLE	N/A	N/A	N/A	N/A	N/A	N/A
GLF	GLZ51A	GLZ51B	GLZ52A	GLZ52B	GLZ54J	GLZ55B
GLG	GLZ51A	GLZ51B	GLZ52A	GLZ52B	GLZ54J	GLZ55B
GLH	GLZ51A	GLZ51B	GLZ52A	GLZ52B	GLZ54J	GLZ55B
GLJ	GLZ51A	GLZ51B	GLZ52A	GLZ52B	GLZ54J	GLZ55B



## LED Assemblies

Body Type	LED Assembly 1-LED	TYPE 2-LED
GLA		
GLB		
GLC		
GLD		
GLE		
GLF	GLZ6F	
GLG		
GLH		GLZ6H
GLJ		

## Parts Description

Heads	
GLZ1AA	Side Rotary Head
GLZ1AB	Top Pin Plunger Head
GLZ1AC	Top Roller Plunger Head
GLZ1AD	Roller Arm Head
GLZ1AE7A	Plastic Wobble Stick Head Assembly
GLZ1AE7B	Coil Wobble Stick Head Assembly
GLZ1AE7D	Coil Whisker Head Assembly
GLZ1AK8A	140mm Cat's Whisker Head Assembly
GLZ1AK8B	190mm Cat's Whisker Head Assembly
GLZ1AK8C	Cat's Whisker Head Assembly
Basics	
GLZ301	Snap Action SPDT (01)
GLZ302	Snap Action SPDT Plug-In (02) see Note 1
GLZ303	SPDT Break Before Make (03)
GLZ304	SPDT Make Before Break (04)
GLZ312	Snap Action SPDT 1 LED Plug-In (12) see Note 1
GLZ313	Snap Action SPDT 2 LED Plug-In (13) see Note 1
GLZ320	Snap Action DPDT (20)
GLZ324	Snap Action DPDT for 3 Conduit (24)
Actuators	
GLZ51A	Side Rotary Fixed Lever Nylon Roller Actuator
GLZ51B	Side Rotary Fixed Lever Steel Roller Actuator
GLZ52A	Side Rotary Adjustable Lever Nylon Roller Actuator
GLZ52B	Side Rotary Adjustable Lever Steel Roller Actuator
GLZ54J	Side Rotary Adjustable Rod Actuator
GLZ55B	Side Rotary Fixed Offset Lever Steel Roller
LED Assemblies	
GLZ6F	Spare 1 LED Assembly for GLF...
GLZ6H	Spare 2 LED Assembly for GLH...

# Proper Application of Limit Switches

The following are guidelines for the correct application of Limit Switches.

Never use the Limit Switch as a physical end stop. Mechanical damage or incorrect operation may occur if this is done. Always ensure that the mechanical actuator is protected from excessive mechanical shock. Never release the actuator suddenly - gradual actuation and release will ensure that stress on the mechanics of the switch is kept to a minimum. This has the added benefit that the switch life will be improved.

The following diagrams illustrate how to actuate your limit switch for optimum performance.

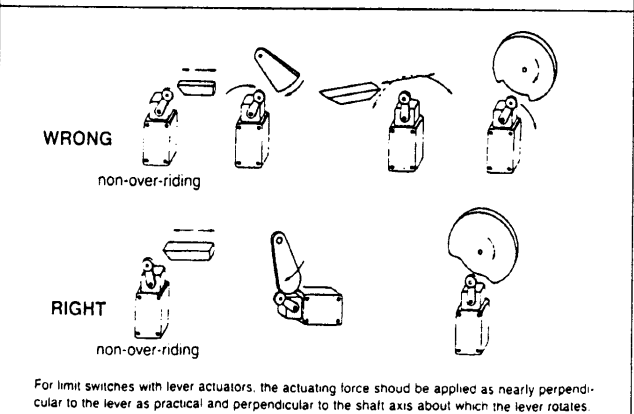
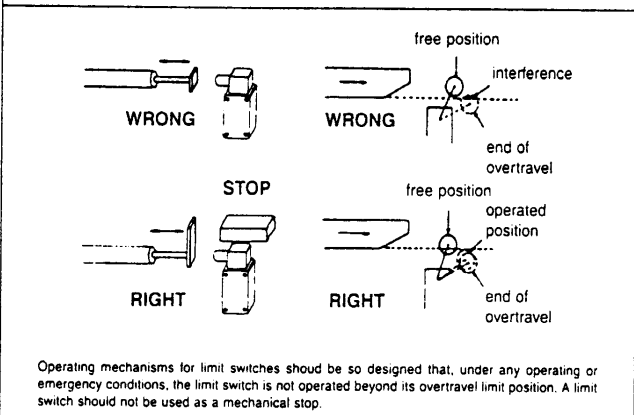
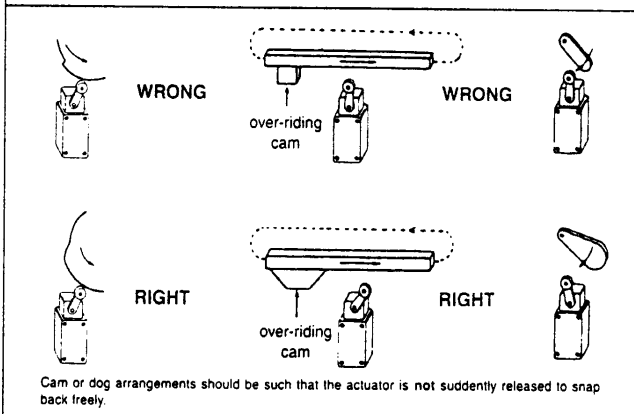
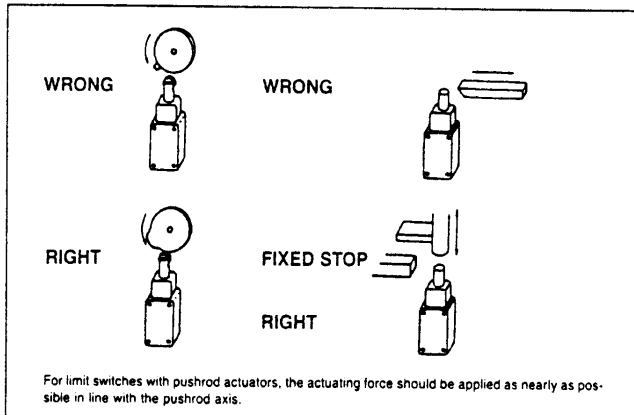

## Tools

The following tools will be needed - depending on the task.

- Posidrive screwdriver n° 1 & n° 2
- Allen key 3 mm

When tightening a screw down the maximum force which should be applied should not exceed 80N.cm (7in.LB) on any screw on the complete assembly or basic switch terminal.

## Mounting Instructions

Mounting, Installation and Wiring of the Limit Switch plays a critical role in the performance of the switch in service. Care should be taken in the position and orientation of the switch for optimum performance. All of the guidelines given below apply equally when replacing parts on the switch.

## Wiring

The GLS series has been designed to accept 14AWG wire maximum. Care should be taken to ensure that the wires are carefully arranged in the switch so that they do not overlap or otherwise interfere with the operation of the switch when the switch cover is replaced. If the wires are trapped between the basic and the cover then the switch may fail to operate correctly - ensure that an adequate gap exists between the fitted wires and the cover when fitted. It is not good practice to have very different diameter wires share the same terminal in the switch - uneven pressure on the wires will result.

## Mounting

The GLS series has been designed to be extremely flexible in mounting. Elongated mounting holes mean that the switch can be adjusted substantially prior to fixing in position. We recommend M4 maximum screws be used for mounting the switch in its application. Fix and test the switch for intended switch point in the application. When mounting the switch ensure that it is positioned to allow natural drainage of any moisture which may enter the enclosure during service. Natural drainage can be achieved by mounting the switch upright with the conduit entry at the bottom of the switch. Mounting the switch in the upright position will enable maintenance and replacement procedures to be carried out easily.

## Adjustment and Set-up

In general no adjustment of the GLS should be necessary beyond correct mounting of the switch body as required. It is possible to change the switch actuator orientation. The example below shows a top roller plunger head rotated through 90°. The other head styles can also be rotated.

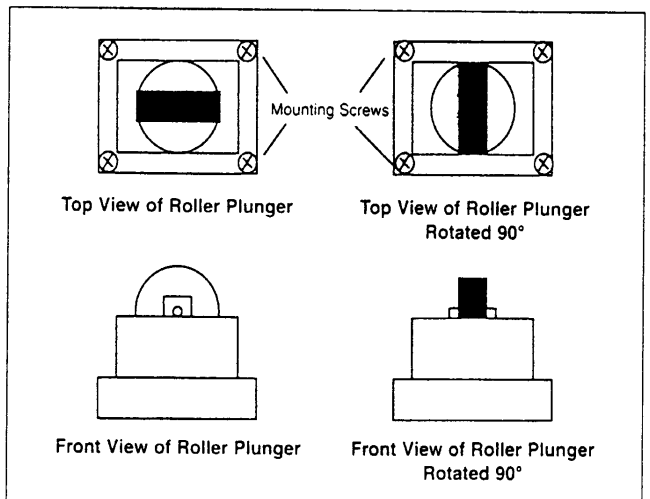

The head can be rotated by carefully removing the four combination head screws holding the head in position. Carefully remove the head assembly and rotate to the desired position. Replace the head assembly and tighten the mounting screws. Ensure that the head is properly located. Hand test the actuator to ensure that the switch