

Power Management LSI Series for Automotive Body Control



Voltage Detector ICs

with Watchdog Timer

**BD37A19FVM, BD37A41FVM, BD87A28FVM, BD87A29FVM
BD87A34FVM, BD87A41FVM, BD99A41F**

●Description

The BD37A19FVM, BD37A41FVM, BD87A28FVM, BD87A29FVM, BD87A34FVM, BD87A41FVM, BD99A41F is a watchdog timer reset IC. It delivers a high precision detection voltage of $\pm 1.5\%$ and a super-low current consumption of $5 \mu\text{A}$ (Typ.). It can be used in a wide range of electronic devices to monitor power supply voltages and in system operation to prevent runaway operation.

●Features

- 1) High precision detection voltage: $\pm 1.5\%$, $\pm 2.5\%$ ($T_a = -40^\circ\text{C}$ to 105°C)
- 2) Super-low current consumption: $5 \mu\text{A}$ (Typ.)
- 3) Built-in watchdog timer
- 4) Reset delay time can be set with the CT pin's external capacitance.
- 5) Watchdog timer monitor time and reset time can be set with the CTW pin's external capacitance.
- 6) Output circuit type: N-channel open drain
- 7) Package: MSOP8(BD37A□□FVM, BD87A□□FVM) / SOP8(BD99A41F)

●Applications

All devices using microcontrollers or DSP, including vehicle equipment, displays, servers, DVD players, and telephone systems.

●Product line

INH logic	H: Active		L: Active
Model	BD37A□□FVM	BD99A41F	BD87A□□FVM
Detection voltage	1.9 V/4.1V	4.1 V	2.8V/2.9V/3.4 V/4.1V

●Absolute maximum ratings ($T_a = 25^\circ\text{C}$)

Parameter	Symbol	Limit	Unit
Power supply voltage	VDD	-0.3 to 10	V
CT pin voltage	VCT	-0.3 to VDD + 0.3	V
CTW pin voltage	VCTW	-0.3 to VDD + 0.3	V
RESET pin voltage	VRESET	-0.3 to VDD + 0.3	V
INH pin voltage	VINH	-0.3 to VDD + 0.3	V
CLK pin voltage	VCLK	-0.3 to VDD + 0.3	V
Power dissipation	Pd	470^{*1}	mW
		550^{*2}	
Operating ambient temperature	Topr	-40 to + 105	°C
Storage temperature	Tstg	-55 to + 125	°C
Maximum junction temperature	Tjmax	125	°C

*1 MSOP8 : Reduced by $4.70 \text{ mW}/^\circ\text{C}$ over 25°C , when mounted on a glass epoxy board (70 mm × 70 mm × 1.6 mm).

*2 SOP8 : Reduced by $5.50 \text{ mW}/^\circ\text{C}$ over 25°C , when mounted on a glass epoxy board (70 mm × 70 mm × 1.6 mm).

●Recommended operating ranges (Ta = -40°C to 105°C)

Parameter	Symbol	Min.	Max.	Unit
RESET power supply voltage	VDD RESET	1.0	10	V
WDT power supply voltage	VDD WDT	2.5	10	V

●Electrical characteristics (Unless otherwise specified, Ta = -40°C to 105°C, VDD = 5 V)

Parameter	Symbol	Limit			Unit	Conditions	
		Min.	Typ.	Max.			
[Overall]							
Total supply current 1 (during WDT operation)	IDD1	—	5	14	μA	INH : WDT ON Logic Input CTW = 0.1 μF	
Total supply current 2 (when WDT stopped)	IDD2	—	5	14	μA	INH : WDT OFF Logic Input	
Output leak current	Ileak	—	—	1	μA	VDD = VDS = 10 V	
Output current capacity	IOL	0.7	—	—	mA	VDD = 1.2 V, VDS = 0.5 V	
[RESET]							
Detection voltage 1	1.9V Detect	VDET1	1.871	1.900	1.929	V	Ta = 25°C
	2.8V Detect	VDET1	2.758	2.800	2.842	V	Ta = 25°C
	2.9V Detect	VDET1	2.886	2.930	2.974	V	Ta = 25°C
	3.4V Detect	VDET1	3.349	3.400	3.451	V	Ta = 25°C
	4.1V Detect	VDET1	4.039	4.100	4.162	V	Ta = 25°C
Detection voltage 2	1.9V Detect	VDET2	1.852	1.900	1.948	V	Ta = -40 to 105°C
	2.8V Detect	VDET2	2.730	2.800	2.870	V	Ta = -40 to 105°C
	2.9V Detect	VDET2	2.857	2.930	3.003	V	Ta = -40 to 105°C
	3.4V Detect	VDET2	3.315	3.400	3.485	V	Ta = -40 to 105°C
	4.1V Detect	VDET2	4.007	4.100	4.202	V	Ta = -40 to 105°C
Hysteresis width	1.9V Detect	Vrhys	VDET × 0.03	VDET × 0.13	VDET × 0.19	V	Ta = -40 to 105°C
	2.8V Detect	Vrhys	VDET × 0.018	VDET × 0.045	VDET × 0.060	V	Ta = -40 to 105°C
	2.9V Detect	Vrhys	VDET × 0.02	VDET × 0.05	VDET × 0.06	V	Ta = -40 to 105°C
	3.4V Detect	Vrhys	VDET × 0.02	VDET × 0.05	VDET × 0.07	V	Ta = -40 to 105°C
	4.1V Detect	Vrhys	VDET × 0.018	VDET × 0.035	VDET × 0.050	V	Ta = -40 to 105°C
RESET transmission delay time: low → high	TPLH	3.9	6.9	10.1	ms	CT = 0.001 μF ^{*1} When VDD = VDET ±0.5 V	
Delay circuit resistance	Rrst	5.8	10.0	14.5	MΩ	VCT = GND	
Delay pin threshold voltage	VCTH	VDD × 0.3	VDD × 0.45	VDD × 0.6	V	RL = 470 KΩ	
Delay pin output current	ICT	150	—	—	μA	VDD = 1.50 V, VCT = 0.5 V	
Min. operating voltage	VOPL	1.0	—	—	V	VOL ≤ 0.4 V, RL = 470 KΩ	
[WDT]							
WDT monitor time	TwH	7.0	10.0	20.0	ms	CTW = 0.01 μF ^{*2}	
WDT reset time	TwL	2.4	3.3	7.0	ms	CTW = 0.01 μF ^{*3}	
Clock input pulse width	TWCLK	500	—	—	ns		
CLK high threshold voltage	VCLKH	VDD × 0.8	—	VDD	V		
CLK low threshold voltage	VCLKL	0	—	VDD × 0.3	V		
CLK high threshold voltage	VINHH	VDD × 0.8	—	VDD	V		
CLK low threshold voltage	VINHL	0	—	VDD × 0.3	V		
CTW charge current	ICTWC	0.25	0.50	0.75	μA	VCTW = 0.2 V	
CTW discharge current	ICTWO	0.75	1.50	2.00	μA	VCTW = 0.8 V	

*1 TPLH can be varied by changing the CT capacitance value.

$$T_{PLH} \text{ (s)} \approx 0.69 \times R_{rst} \text{ (M}\Omega\text{)} \times C_T \text{ (}\mu\text{F)} \quad R_{rst} = 10 \text{ M}\Omega \quad \text{(Typ.)}$$

*2 TwH can be varied by changing the CT capacitance value.

$$T_{wH} \text{ (s)} \approx (0.5 \times C_{TW} \text{ (}\mu\text{F)}) / I_{CTWC} \text{ (}\mu\text{A)} \quad I_{CTWC} = 0.5 \text{ }\mu\text{A} \quad \text{(Typ.)}$$

*3 TwL can be varied by changing the CTW capacitance value.

$$T_{wL} \text{ (s)} \approx (0.5 \times C_{TW} \text{ (}\mu\text{F)}) / I_{CTWO} \text{ (}\mu\text{A)} \quad I_{CTWO} = 1.5 \text{ }\mu\text{A} \quad \text{(Typ.)}$$

Note: This IC is not designed to be radiation-resistant.

●Reference data (Unless otherwise specified, Ta = 25°C) : 4.1V Detection

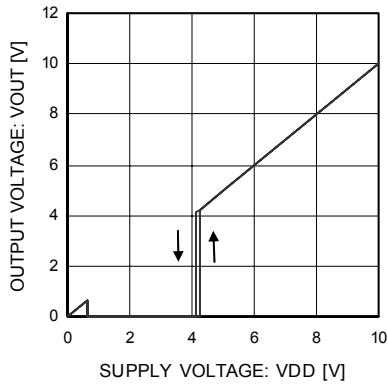

Fig. 1 Detection Voltage

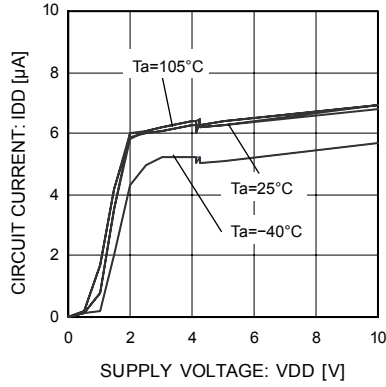

Fig. 2 Total Supply Current

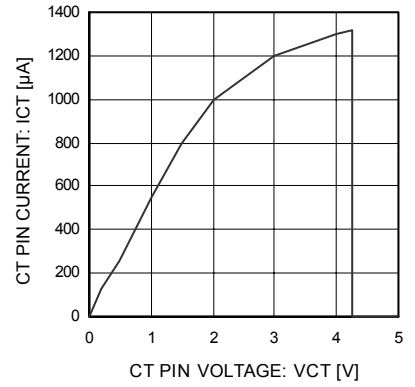

Fig. 3 Delay Pin Current vs Power Supply Voltage

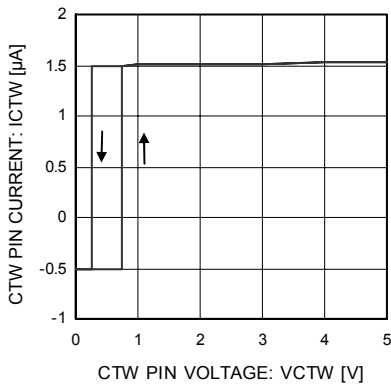

Fig. 4 CTW Charge Discharge Current

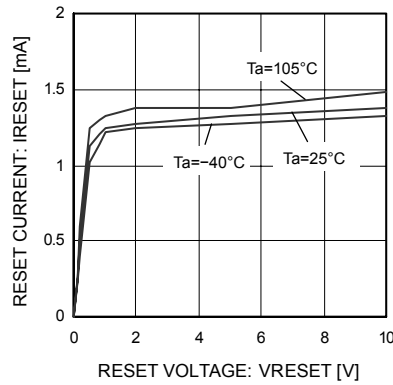

Fig. 5 Output Current

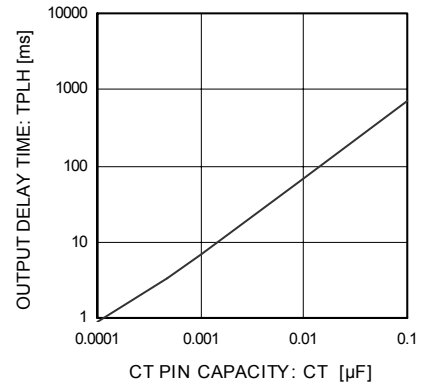

Fig. 6 RESET Transmission Delay Time vs Capacitance

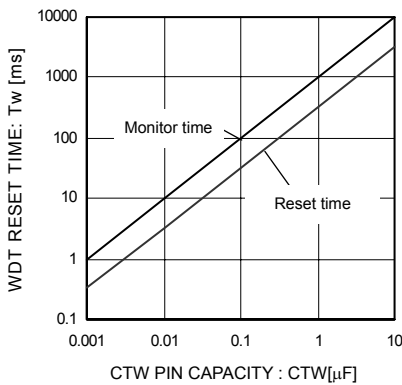

Fig. 7 WDT Time vs Capacitance

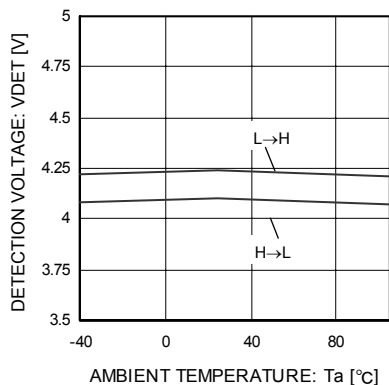

Fig. 8 Detection Voltage vs Temperature

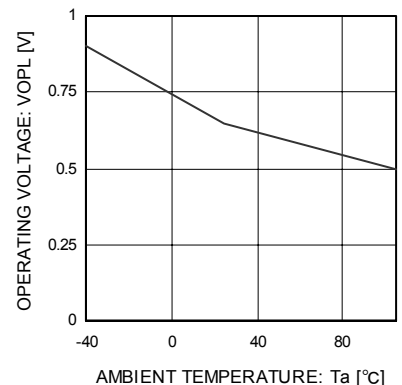

Fig. 9 Operating Marginal Voltage vs Temperature

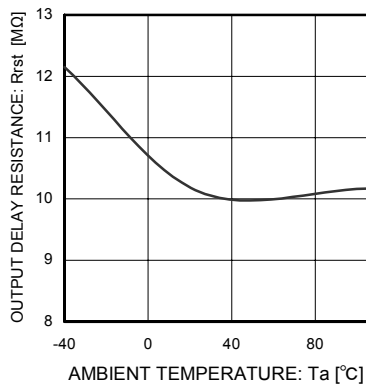

Fig. 10 CT Pin Circuit Resistance vs Temperature

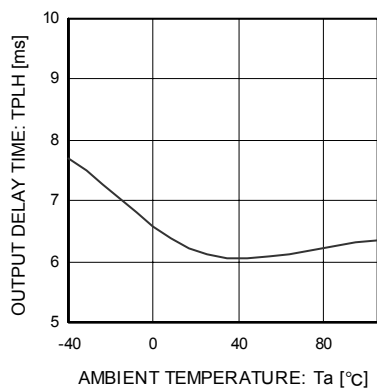

Fig. 11 RESET Transmission Delay Time vs Temperature

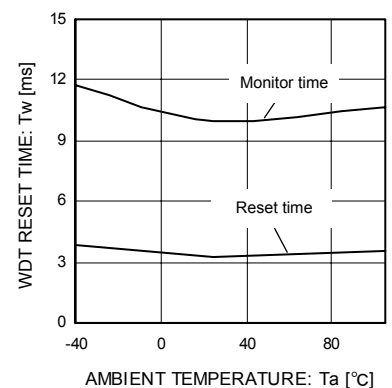
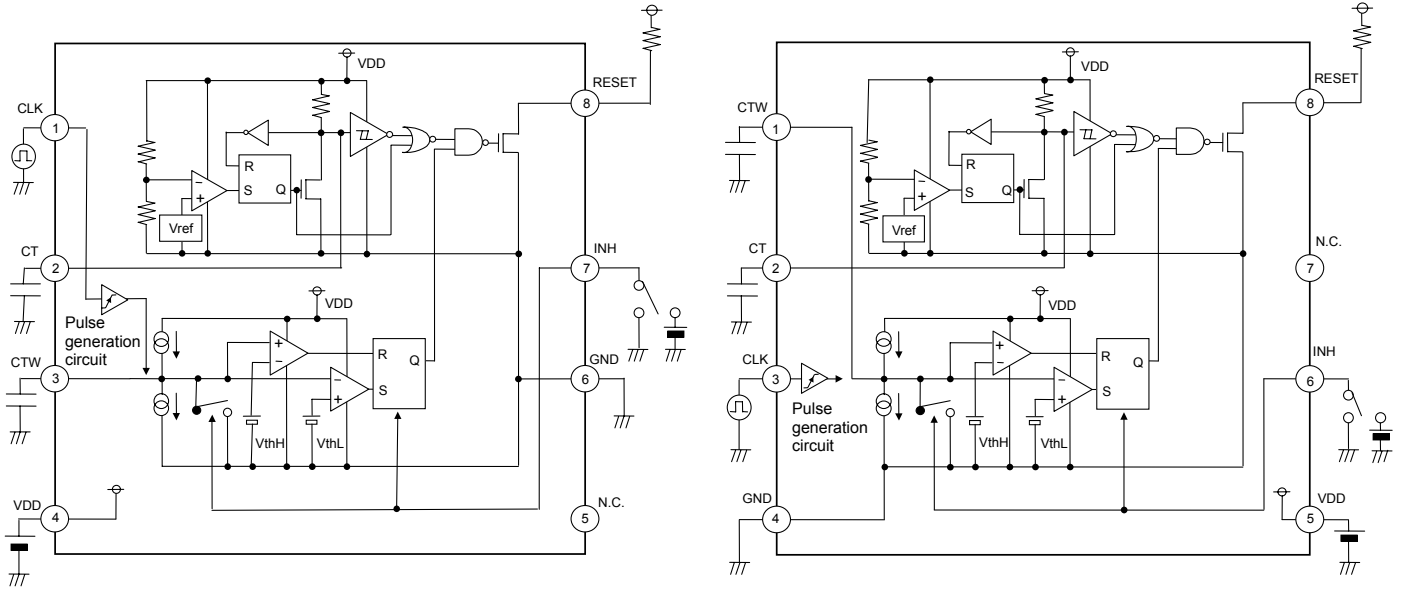

Fig. 12 WDT Time vs Temperature

●Block diagram

BD37A□□FVM

BD87A□□FVM/BD99A41F



CT pin capacitor: 470 pF to 3.3 μF
 CTW pin capacitor: 0.001 μF to 10 μF

Fig.13

●Pin assignments

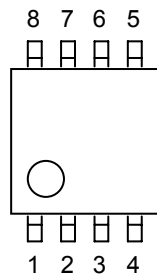

Fig.14

BD37A□□FVM

BD87A□□FVM/BD99A41F

No.	Pin name	Function
1	CLK	Clock input from microcontroller
2	CT	Reset delay time setting capacitor connection pin
3	CTW	WDT time setting capacitor connection pin
4	VDD	Power supply pin
5	N.C.	NC pin
6	GND	GND pin
7	INH	WDT on/off setting pin INH=H/L:WDT=ON/OFF
8	RESET	Reset output pin

No.	Pin name	Function
1	CTW	WDT time setting capacitor connection pin
2	CT	Reset delay time setting capacitor connection pin
3	CLK	Clock input from microcontroller
4	GND	GND pin
5	VDD	Power supply pin
6	INH	WDT on/off setting pin INH=H/L:WDT=OFF/ON(BD87A□□FVM) INH=H/L:WDT=ON/OFF(BD99A41F)
7	N.C.	NC pin
8	RESET	Reset output pin

● I/O Circuit diagram

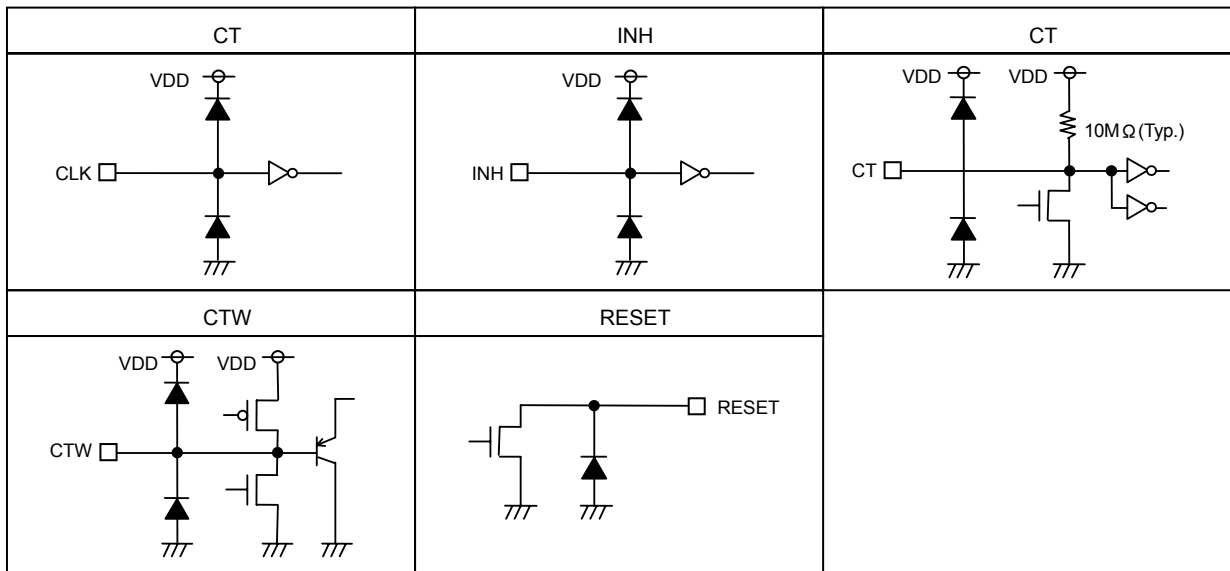

Fig.15

● Timing chart

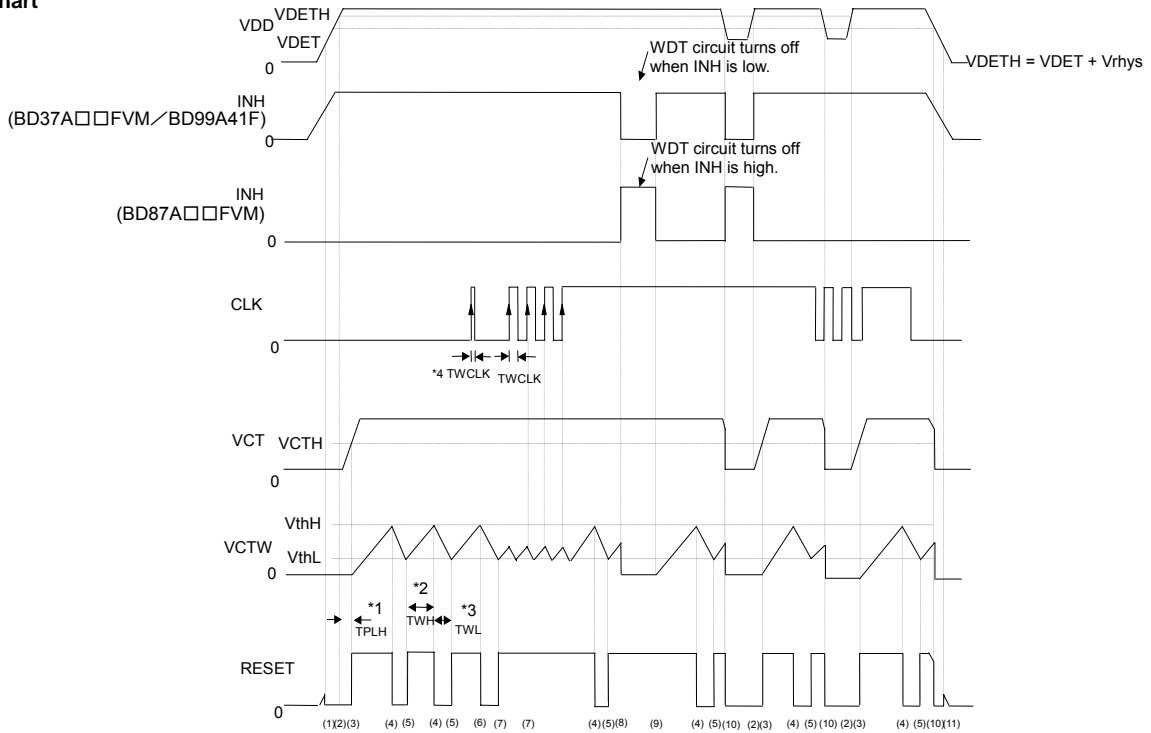

Fig.16

● Explanation

- (1) The RESET pin voltage (RESET) switches to low when the power supply voltage (VDD) falls to 0.8 V.
- (2) The external capacitor connected to the CT pin begins to charge when VDD rises above the reset detection voltage (VDETH). The RESET signal stays low until VDD reaches the VDETH voltage and switches to high when VDD reaches or exceeds the VDETH voltage. The RESET transmission delay time TPLH allowed to elapse before RESET switches from low to high is given by the following equation:

$$TPLH (s) \approx 0.69 \times Rrst \times CT (\mu F) \cdot \cdot [1]$$
 Rrst denotes the IC's built-in resistance and is designed to be 10 MΩ (Typ.). CT denotes the external capacitor connected to the CT pin.
- (3) The external capacitor connected to the CTW pin begins to charge when RESET rises, triggering the watchdog timer.
- (4) The CTW pin state switches from charge to discharge when the CTW pin voltage (VCTW) reaches VthH, and RESET switches from high to low. The watchdog timer monitor time TWH is given by the following equation:

$$TWH (s) \approx (0.5 \times CTW (\mu F)) / (ICTWC) \cdot \cdot [2]$$
 ICTWC denotes the CTW charge current and is designed to be 0.50 μA (Typ.). CTW denotes the external capacitor connected to the CTW pin.

- (5) The CTW pin state switches from charge to discharge when VCTW reaches VthL, and RESET switches from low to high. The watchdog timer reset time TWL is given by the following equation:

$$TWL (s) \approx (0.5 \times CTW (\mu F)) / (ICTWO) \cdot \cdot [3]$$
 ICTWO denotes the CTW discharge current and is designed to be 1.50 μA (Typ.).
- (6) The CTW pin state may not switch from charge to discharge when the CLK input pulse width TWCLK is short. Use a TWCLK input pulse width of at least 500 ns.

$$TWCLK \geq 500 \text{ ns (Min.)}$$
- (7) When a pulse (positive edge trigger) of at least 500 ns is input to the CLK pin while the CTW pin is charging, the CTW state switches from charge to discharge. Once it discharges to VthL, it will charge again.
- (8) Watchdog timer operation is forced off when the INH pin switches to low:BD37A□□FVM (Switches to high:BD87A□□FVM,BD97A41F). At that time, only the watchdog timer is turned off. Reset detection is performed normally.
- (9) The watchdog timer function turns on when the INH pin switches to high. The external capacitor connected to the CTW pin begins to charge at that time.
- (10) RESET switches from high to low when VDD falls to the RESET detection voltage (VDET) or lower.
- (11) When VDD falls to 0 V, the RESET signal stays low until VDD reaches 0.8 V.

●Heat reduction curve

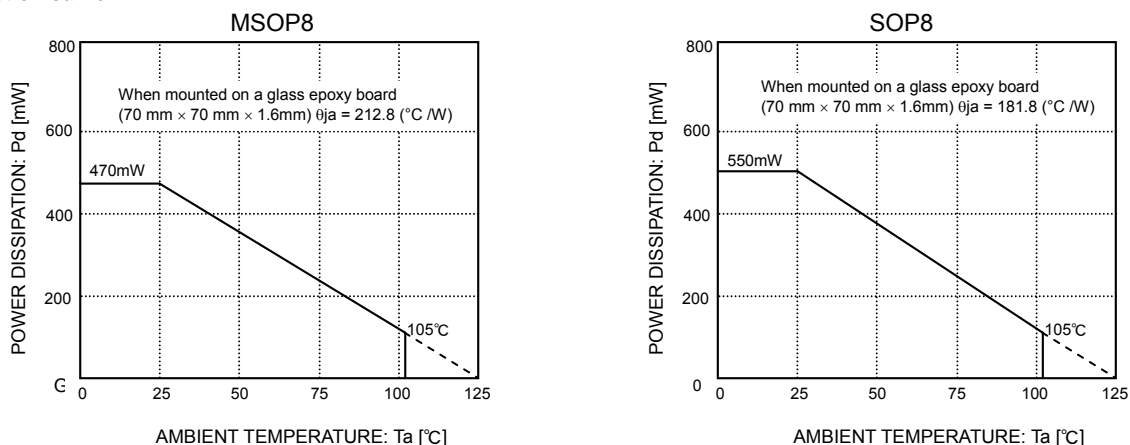

Fig.17

●External settings for pins and precautions

- 1) Connect a capacitor (0.001 μF to 1,000 μF) between the VDD and GND pins when the power line impedance is high. Use of the IC when the power line impedance is high may result in oscillation.

2) External capacitance

A capacitor must be connected to the CTW pin. When using a large capacitor such as 1 μF , the INH pin must allow a CTW discharge time of at least 2 ms. The power-on reset time is given by equation [1] on page 5. The WDT time is given by equations [2] and [3] on page 5, 6. The setting times are proportional to the capacitance value from the equations, so the maximum and minimum setting times can be calculated from the electrical characteristics according to the capacitance. Note however that the electrical characteristics do not include the external capacitor's temperature characteristics.

●Operation Notes

1. Absolute maximum ratings
 An excess in the absolute maximum ratings, such as supply voltage, temperature range of operating conditions, etc., can break down the devices, thus making impossible to identify breaking mode, such as a short circuit or an open circuit. If any over rated values will expect to exceed the absolute maximum ratings, consider adding circuit protection devices, such as fuses.
2. GND voltage
 The potential of GND pin must be minimum potential in all operating conditions.
3. Thermal design
 Use a thermal design that allows for a sufficient margin in light of the power dissipation (Pd) in actual operating conditions.
4. Inter-pin shorts and mounting errors
 Use caution when positioning the IC for mounting on printed circuit boards. The IC may be damaged if there is any connection error or if pins are shorted together.

5. Actions in strong electromagnetic field

Use caution when using the IC in the presence of a strong electromagnetic field as doing so may cause the IC to malfunction.

6. Testing on application boards

When testing the IC on an application board, connecting a capacitor to a pin with low impedance subjects the IC to stress. Always discharge capacitors after each process or step. Always turn the IC's power supply off before connecting it to or removing it from a jig or fixture during the inspection process. Ground the IC during assembly steps as an antistatic measure. Use similar precaution when transporting or storing the IC.

7. Regarding input pin of the IC

This monolithic IC contains P+ isolation and P substrate layers between adjacent elements in order to keep them isolated. P-N junctions are formed at the intersection of these P layers with the N layers of other elements, creating a parasitic diode or transistor. For example, the relation between each potential is as follows:

When $GND > Pin A$ and $GND > Pin B$, the P-N junction operates as a parasitic diode.

When $GND > Pin B$, the P-N junction operates as a parasitic transistor.

Parasitic diodes can occur inevitable in the structure of the IC. The operation of parasitic diodes can result in mutual interference among circuits, operational faults, or physical damage. Accordingly, methods by which parasitic diodes operate, such as applying a voltage that is lower than the GND (P substrate) voltage to an input pin, should not be used.

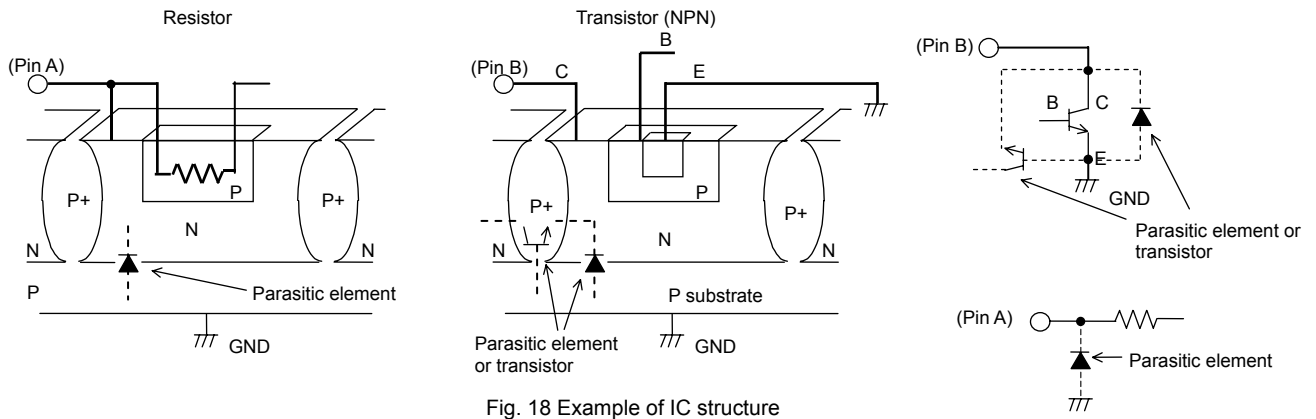

Fig. 18 Example of IC structure

8. Ground Wiring Pattern

When using both small signal and large current GND patterns, it is recommended to isolate the two ground patterns, placing a single ground point at the ground potential of application so that the pattern wiring resistance and voltage variations caused by large currents do not cause variations in the small signal ground voltage. Be careful not to change the GND wiring pattern of any external components, either.

9. Applications or inspection processes with modes where the potentials of the VDD pin and other pins may be reversed from their normal states may cause damage to the IC's internal circuitry or elements. Use an output pin capacitance of 1000μF or lower in case VDD is shorted with the GND pin while the external capacitor is charged. It is recommended to insert a diode for preventing back current flow in series with VDD or bypass diodes between Vcc and each pin.

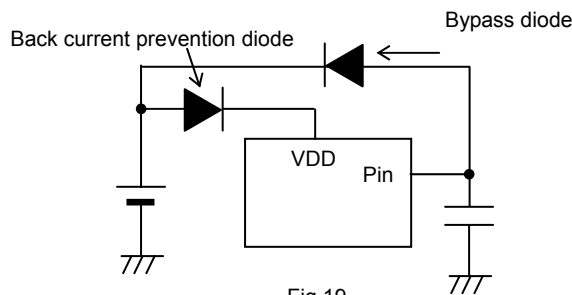

Fig.19

10. When VDD falls below the operating marginal voltage, output will be open. When output is being pulled up to input, output will be equivalent to VDD.

11. Input pin

The CLK and INH pins comprise inverter gates and should not be left open. (These pins should be either pulled up or down.) Input to the CLK pin is detected using a positive edge trigger and does not affect the CLK signal duty. Input the trigger to the CLK pin within the TWH time.

●Selecting a model name when ordering

B D

ROHM model name

3 7 A 4 1

Part number
37A: H Active
87A: L Active
99A: H Active

F V M

Detection voltage

Package type
FVM : MSOP8
F : SOP8

- T R

Taping

E2: Reel-wound embossed taping
TR: Reel-wound embossed taping

MSOP8

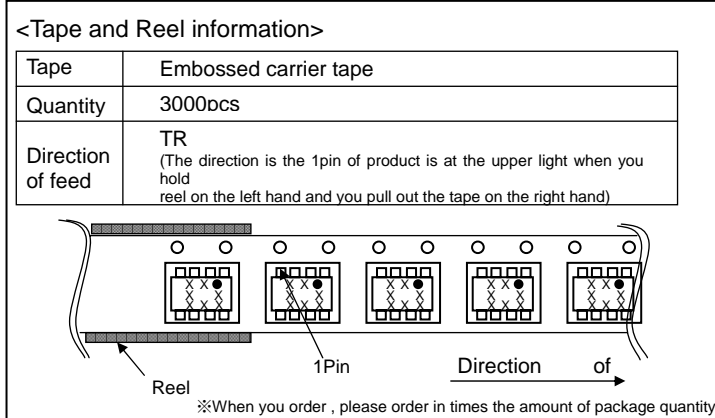
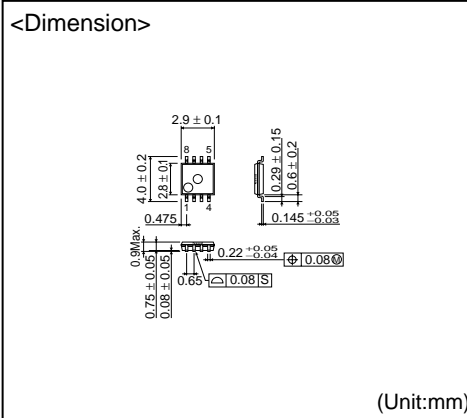

SOP8

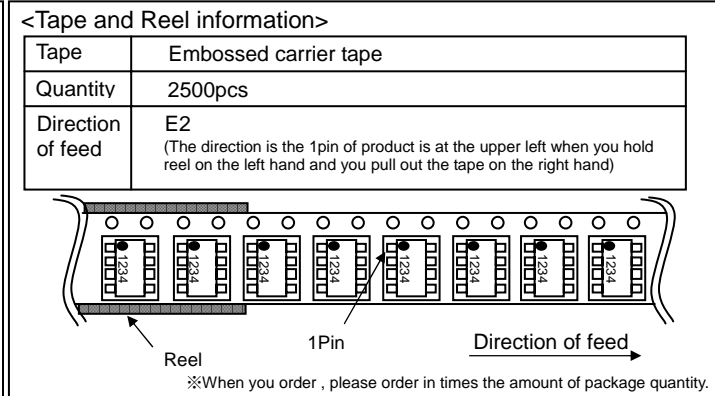
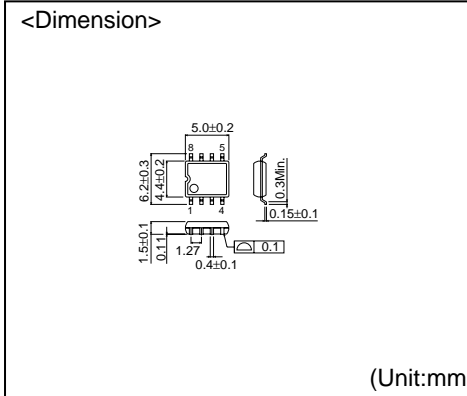

- The contents described herein are correct as of July, 2006
- The contents described herein are subject to change without notice. For updates of the latest information, please contact and confirm with ROHM CO.,LTD.
- Any part of this application note must not be duplicated or copied without our permission.
- Application circuit diagrams and circuit constants contained herein are shown as examples of standard use and operation. Please pay careful attention to the peripheral conditions when designing circuits and deciding upon circuit constants in the set.
- Any data, including, but not limited to application circuit diagrams and information, described herein are intended only as illustrations of such devices and not as the specifications for such devices. ROHM CO.,LTD. disclaims any warranty that any use of such devices shall be free from infringement of any third party's intellectual property rights or other proprietary rights, and further, assumes no liability of whatsoever nature in the event of any such infringement, or arising from or connected with or related to the use of such devices.
- Upon the sale of any such devices, other than for buyer's right to use such devices itself, resell or otherwise dispose of the same, implied right or license to practice or commercially exploit any intellectual property rights or other proprietary rights owned or controlled by ROHM CO., LTD. is granted to any such buyer.
- The products described herein utilize silicon as the main material.
- The products described herein are not designed to be X ray proof.

The products listed in this catalog are designed to be used with ordinary electronic equipment or devices (such as audio visual equipment, office-automation equipment, communications devices, electrical appliances and electronic toys). Should you intend to use these products with equipment or devices which require an extremely high level of reliability and the malfunction of which would directly endanger human life (such as medical instruments, transportation equipment, aerospace machinery, nuclear-reactor controllers, fuel controllers and other safety devices), please be sure to consult with our sales representative in advance.

Contact us for further information about the products.

- | | | | |
|--|------------------------|---|-----------------------|
| Seoul TEL: +82-2-8182-700 | FAX: +82-2-8182-715 | Bangkok TEL: +66-2-254-4890 | FAX: +66-2-256-6334 |
| Masan TEL: +82-55-240-6234 | FAX: +82-55-240-6236 | Kuala Lumpur TEL: +60-3-7958-8355 | FAX: +60-3-7958-8377 |
| Dalian TEL: +86-411-8230-8549 | FAX: +86-411-8230-8537 | Penang TEL: +60-4-6585084 | FAX: +60-4-6585167 |
| Beijing TEL: +86-10-8525-2483 | FAX: +86-10-8525-2489 | Dusseldorf TEL: +49-2145-9210 | FAX: +49-2154-921400 |
| Tianjin TEL: +86-22-23029181 | FAX: +86-22-23029183 | Munich TEL: +49-8161-48310 | FAX: +49-8161-483120 |
| Shanghai TEL: +86-21-6279-2727 | FAX: +86-21-6247-2066 | Stuttgart TEL: +49-711-72723710 | FAX: +49-711-72723720 |
| Hangzhou TEL: +86-571-87658072 | FAX: +86-571-87658071 | France TEL: +33-1-5697-3060 | FAX: +33-1-5697-3080 |
| Nanjing TEL: +86-25-8689-0015 | FAX: +86-25-8689-0393 | United Kingdom TEL: +44-1-908-306700 | FAX: +44-1-908-235788 |
| Ningbo TEL: +86-574-87654201 | FAX: +86-574-87654208 | Denmark TEL: +45-3694-4739 | FAX: +45-3694-4789 |
| Qingdao TEL: +86-532-5779-312 | FAX: +86-532-5779-653 | Barcelona TEL: +34-9375-24320 | FAX: +34-9375-24410 |
| Suzhou TEL: +86-512-6807-1300 | FAX: +86-512-6807-2300 | Malaga TEL: +34-9520-20263 | FAX: +34-9520-20023 |
| Tianjin TEL: +86-22-23029181 | FAX: +86-22-23029183 | Hungary TEL: +36-1-4719338 | FAX: +36-1-4719339 |
| Wuxi TEL: +86-510-82702693 | FAX: +86-510-82702992 | Poland TEL: +48-22-5757213 | FAX: +48-22-5757001 |
| Hong Kong TEL: +852-2-740-6262 | FAX: +852-2-375-8971 | Russia TEL: +7-95-980-6755 | FAX: +7-95-937-8290 |
| Dongguan TEL: +86-769-393-3320 | FAX: +86-769-398-4140 | San Diego TEL: +1-858-625-3630 | FAX: +1-858-625-3670 |
| Fuzhou TEL: +86-591-8801-8698 | FAX: +86-591-8801-8690 | Atlanta TEL: +1-770-754-5972 | FAX: +1-770-754-0691 |
| Guangzhou TEL: +86-20-8364-9796 | FAX: +86-20-8364-9707 | Boston TEL: +1-978-371-0382 | FAX: +1-928-438-7164 |
| Shenzhen TEL: +86-755-8307-3001 | FAX: +86-755-8307-3003 | Chicago TEL: +1-847-368-1006 | FAX: +1-847-368-1008 |
| Xiamen TEL: +86-592-239-8382 | FAX: +86-592-239-8380 | Dallas TEL: +1-972-312-8818 | FAX: +1-972-312-0330 |
| Zhuhai TEL: +86-756-3232-480 | FAX: +86-756-3232-460 | Denver TEL: +1-303-708-0908 | FAX: +1-303-708-0858 |
| Taipei TEL: +886-2-2500-6956 | FAX: +886-2-2503-2869 | Nashville TEL: +1-615-620-6700 | FAX: +1-615-620-6702 |
| Kaohsiung TEL: +886-7-237-0881 | FAX: +886-7-238-7332 | Guadalajara TEL: +52-33-3123-2001 | FAX: +52-33-3123-2002 |
| Singapore TEL: +65-6332-2322 | FAX: +65-6332-5662 | | |
| Manila TEL: +63-2-807-6872 | FAX: +63-2-809-1422 | | |

Excellence in Electronics



ROHM CO., LTD.

21, Saiin Mizosaki-cho, Ukyo-ku, Kyoto
615-8585, Japan
TEL: +81-75-311-2121 FAX: +81-75-315-0172
URL: http://www.rohm.com

Published by
LSI Application Engineering Dept.

Notes

- No technical content pages of this document may be reproduced in any form or transmitted by any means without prior permission of ROHM CO.,LTD.
- The contents described herein are subject to change without notice. The specifications for the product described in this document are for reference only. Upon actual use, therefore, please request that specifications to be separately delivered.
- Application circuit diagrams and circuit constants contained herein are shown as examples of standard use and operation. Please pay careful attention to the peripheral conditions when designing circuits and deciding upon circuit constants in the set.
- Any data, including, but not limited to application circuit diagrams information, described herein are intended only as illustrations of such devices and not as the specifications for such devices. ROHM CO.,LTD. disclaims any warranty that any use of such devices shall be free from infringement of any third party's intellectual property rights or other proprietary rights, and further, assumes no liability of whatsoever nature in the event of any such infringement, or arising from or connected with or related to the use of such devices.
- Upon the sale of any such devices, other than for buyer's right to use such devices itself, resell or otherwise dispose of the same, no express or implied right or license to practice or commercially exploit any intellectual property rights or other proprietary rights owned or controlled by
- ROHM CO., LTD. is granted to any such buyer.
- Products listed in this document are no antiradiation design.

The products listed in this document are designed to be used with ordinary electronic equipment or devices (such as audio visual equipment, office-automation equipment, communications devices, electrical appliances and electronic toys).

Should you intend to use these products with equipment or devices which require an extremely high level of reliability and the malfunction of which would directly endanger human life (such as medical instruments, transportation equipment, aerospace machinery, nuclear-reactor controllers, fuel controllers and other safety devices), please be sure to consult with our sales representative in advance.

It is our top priority to supply products with the utmost quality and reliability. However, there is always a chance of failure due to unexpected factors. Therefore, please take into account the derating characteristics and allow for sufficient safety features, such as extra margin, anti-flammability, and fail-safe measures when designing in order to prevent possible accidents that may result in bodily harm or fire caused by component failure. ROHM cannot be held responsible for any damages arising from the use of the products under conditions out of the range of the specifications or due to non-compliance with the NOTES specified in this catalog.

Thank you for your accessing to ROHM product informations.

More detail product informations and catalogs are available, please contact your nearest sales office.

ROHM Customer Support System

THE AMERICAS / EUROPE / ASIA / JAPAN

www.rohm.com

Contact us : webmaster@rohm.co.jp