

## Solid-state Twin Timer

## H3DE-F

- Operates in flicker-OFF or flicker-ON start mode with one Unit.
- Independent ON- and OFF-time settings. Combinations of long ON- or OFF-time and short OFF- or ON-time setting are possible.
- Long time range from 0.1 s to 12 h for both ON and OFF time settings.



### Ordering Information

Operating mode	Supply voltage	Model
Flicker-OFF/Flicker-ON start	24 to 230 VAC/VDC	H3DE-F

#### ■ Model Number Legend

H3DE -   
1

1. F: Twin timers

#### ■ Accessories (Order Separately)

<b>Mounting Track</b>	50 cm (l) x 7.3 mm (t)	PFP-50N
	1 m (l) x 7.3 mm (t)	PFP-100N
	1 m (l) x 16 mm (t)	PFP-100N2
<b>End Plate</b>	PFP-M	
<b>Spacer</b>	PFP-S	

# Specifications

## ■ General

Item	H3DE-F
Operating mode	Flicker-OFF/Flicker-ON start
Operating/Reset method	Time-limit operation/Time-limit reset or self-reset
Terminal block	Clamps two 2.5 mm <sup>2</sup> max. bar terminals without sleeves
Terminal screw tightening torque	0.98 N • m max. {approx. 10 kgf • cm max.}
Output type	Relay: SPDT
Mounting method	DIN track mounting (see note)
Attachment	Nameplate
Approved standards	UL508, CSA 22.2 No.14 Conforms to EN61812-1, IEC60664-1 (VDE0110) 4 kV/2, VDE0106/P 100 Output category according to IEC60947-5-1 (AC-13; 250 V 5A/AC-15; 250 V 3 A/DC-13; 30 V 0.1 A)

**Note:** Can be mounted to 35-mm DIN track with a plate thickness of 1 to 2.5 mm.

## ■ Time Ranges

Time scale display (see note 1)	Time unit display			
	sec	10 s	min	hrs
x 0.1	0.1 to 1.2 s	1 to 12 s	0.1 to 1.2 min	0.1 to 1.2 h
x 1	1 to 12 s	10 to 120 s	1 to 12 min	1 to 12 h

- Note:** 1. Time scale display is applied commonly for ON and OFF time.  
2. When the main dial is set to "0" for all settings, the output will operate instantaneously.

## ■ Ratings

Rated supply voltage (see note)	24 to 230 VAC/VDC (50/60 Hz)
Operating voltage range	85% to 110% of rated supply voltage
Power reset	Minimum power-off time: 0.1 s
Reset voltage	2.4 VAC/DC max.
Power consumption	AC: Approx. 3.1 VA (1.8 W) at 230 VAC DC: Approx. 0.8 W at 24 VDC
Control output	Contact output: 5 A at 250 VAC with resistive load ( $\cos\phi = 1$ ) 5 A at 30 VDC with resistive load ( $\cos\phi = 1$ )
Ambient temperature	Operating: -10°C to 55°C (with no icing) Storage: -25°C to 65°C (with no icing)
Ambient humidity	Operating: 35% to 85%

**Note:** DC ripple rate: 20% max.

## ■ Characteristics

<b>Accuracy of operating time</b>	±1% max. of FS (±1% ±10 ms max. at 1.2-s range)
<b>Setting error</b>	±10% ± 0.05 s max. of FS
<b>Influence of voltage</b>	±0.5% max. of FS (±0.5% ±10 ms max. at 1.2-s range)
<b>Influence of temperature</b>	±2% max. of FS (±2% ± 10 ms max. at 1.2-s range)
<b>Insulation resistance</b>	100 MΩ min. at 500 VDC
<b>Dielectric strength</b>	Between current-carrying metal parts and exposed non-current-carrying metal parts: 2,000 VAC (50/60 Hz) for 1 min. Between control output terminals and operating circuit: 2,000 VAC (50/60 Hz) for 1 min. Between contacts not located next to each other: 1,000 VAC (50/60 Hz) for 1 min.
<b>Impulse withstand voltage</b>	3 kV (between power supply terminals) 4.5 kV (between current-carrying metal parts and exposed non-current-carrying metal parts)
<b>Noise immunity</b>	Square-wave noise generated by noise simulator (pulse width: 100 ns/1 μs, 1-ns rise) ±1.5 kV
<b>Static immunity</b>	Malfunction: 4 kV Destruction: 8 kV
<b>Vibration resistance</b>	Malfunction: 0.5-mm single amplitude at 10 to 55 Hz Destruction: 0.75-mm single amplitude at 10 to 55 Hz
<b>Shock resistance</b>	Malfunction: 100 m/s <sup>2</sup> (approximately 10G) Destruction: 1,000 m/s <sup>2</sup> (approximately 100G)
<b>Life expectancy</b>	Mechanical: 10 million operations min. (under no load at 1,800 operations/h) Electrical: 100,000 operations min. (5 A at 250 VAC, resistive load at 360 operations/h)
<b>EMC</b>	(EMI) Emission Enclosure: EN55011 Group 1 class B Emission AC Mains: EN55011 Group 1 class B (EMS) Immunity ESD: EN61000-4-2: 6 kV contact discharge (level 3) 8 kV air discharge (level 3) Immunity RF-interference from AM Radio Waves: EN61000-4-3: 10 V/m (80 MHz to 1 GHz) (level 3) Immunity Burst: EN61000-4-4: 2 kV power port and output port (level 3) 1 kV control port with capacitive clamp (level 3) Immunity Surge: EN61000-4-5: 2 kV common mode (level 3) 1 kV differential mode (level 3)
<b>Enclosure rating</b>	IP30 (IP20 for terminal block)
<b>Weight</b>	Approx. 110 g

**Note:** For reference:

A maximum current of 0.15 A can be switched at 125 VDC (cosφ=1).

A maximum current of 0.1 A can be switched if L/R is 7 ms.

In both cases, a life of 100,000 operations can be expected.

The minimum applicable load is 10 mA at 5 VDC (failure level: P).

# Nomenclature

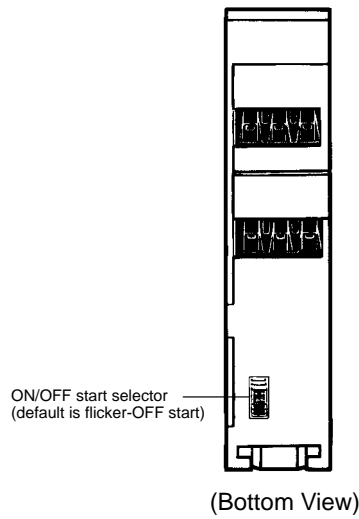
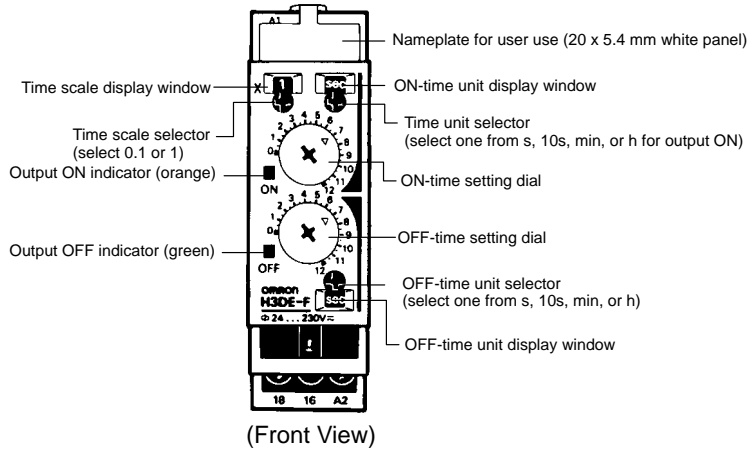

ON/OFF Start Selector Switch Settings

Setting	Operating mode
	Flicker-ON start
	Flicker-OFF start

# Operation

## ■ Block Diagram

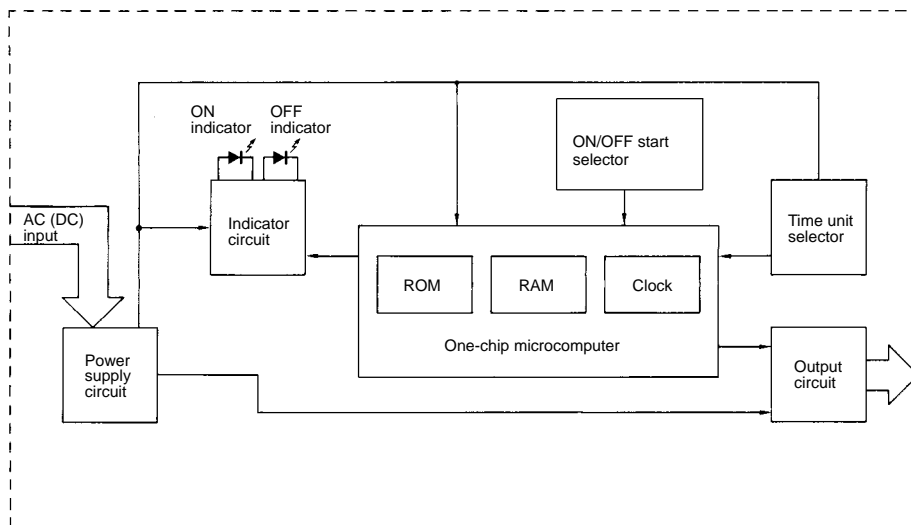

■ I/O Function

Inputs	---	
Outputs	Control output	Outputs are turned ON/OFF according to the time set by the ON-and OFF-time setting dial.

■ Basic Operation

Time Unit Selection

The time unit display window for output ON is located on the upper-right side of the front panel above the corresponding time unit selector.

The time unit display window for output OFF is located on the lower-right side of the front panel below the corresponding time unit selector.

According to the setting of each time unit selector, "sec" for seconds, "10s" for 10 seconds, "min" for minutes, or "hrs" for hours will appear in the corresponding time unit display window.

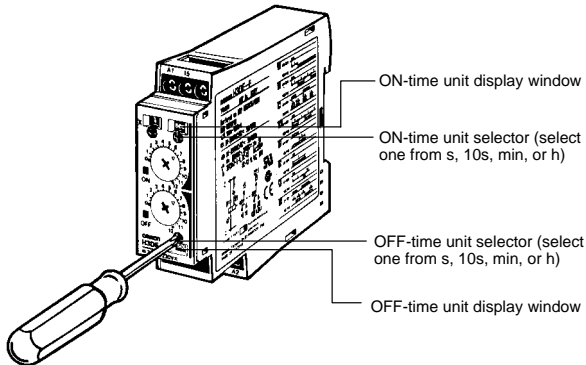

Time Scale Selection

The time scale selector on the upper-left side of the front panel can be set to 0.1 or 1 as a magnification coefficient.

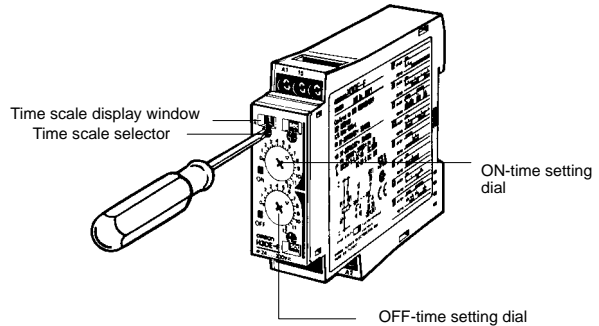

Time Setting

Use the ON/OFF-time setting dial to set the ON/OFF time.

■ Timing Charts

Operating mode	Timing chart	
Flicker-OFF start	<p>Power (A<sub>1</sub> and A<sub>2</sub>)</p> <p>Output relay: NO 15 and 18 (ON indicator)</p> <p>Output relay: NC 15 and 16</p> <p>OFF indicator</p>	<p><math>t_{ON}</math>: ON set time <math>t_{OFF}</math>: OFF set time</p>
Flicker-ON start	<p>Power (A<sub>1</sub> and A<sub>2</sub>)</p> <p>Output relay: NO 15 and 18 (ON indicator)</p> <p>Output relay: NC 15 and 16</p> <p>OFF indicator</p>	<p><math>t_{ON}</math>: ON set time <math>t_{OFF}</math>: OFF set time</p>

- Note:**
1. The reset time requires a minimum of 0.1 s.
  2. When power is supplied in flicker-ON start mode, the OFF indicator lights momentarily. This, however, has no effect on the performance of the Timer.

# Dimensions

H3DE-F

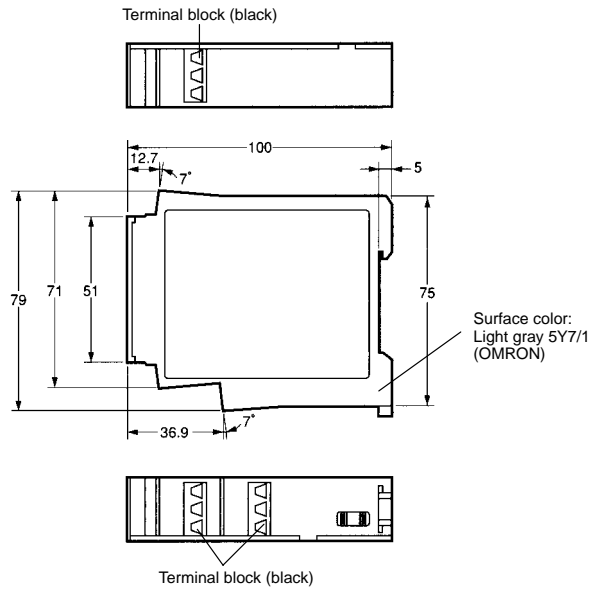
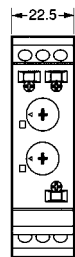
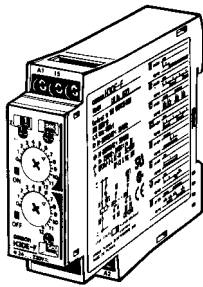

# Installation

## Terminal Arrangement

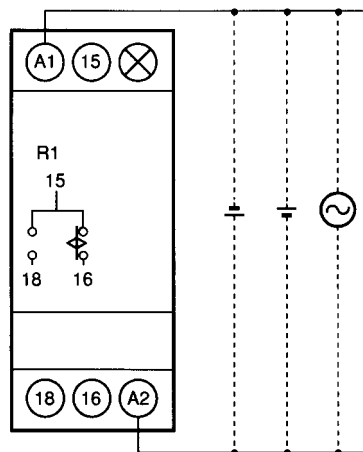

**Note:** DC supply voltage does not require the designation of polarity.