

LOW-INPUT-VOLTAGE CURRENT-LIMITED LOAD SWITCHES WITH SHUT OFF AND AUTO-RESTART FEATURE

Check for Samples: [TPS22941](#) [TPS22942](#) [TPS22943](#) [TPS22944](#) [TPS22945](#)

FEATURES

- **Input Voltage Range: 1.62 V to 5.5 V**
- **Low ON resistance**
 - $r_{ON} = 0.4 \Omega$ at $V_{IN} = 5.5 V$
 - $r_{ON} = 0.5 \Omega$ at $V_{IN} = 3.3 V$
 - $r_{ON} = 0.6 \Omega$ at $V_{IN} = 2.5 V$
 - $r_{ON} = 0.8 \Omega$ at $V_{IN} = 1.8 V$
- **Minimum Current Limit: 40 mA or 100 mA**
- **Undervoltage Lockout**
- **Thermal Shutdown**
- **Shutdown Current < 1 μ A**
- **Fast Current Limit Response Time**
- **Fault Blanking**
- **Auto Restart**
- **1.8-V Compatible Control Input Thresholds**
- **ESD Performance Tested Per JESD 22**
 - **4000-V Human-Body Model (A114-B, Class II)**
 - **1000-V Charged-Device Model (C101)**
- **Tiny SC-70 (DCK) Package**

APPLICATIONS

- **Low-Current Sensor Protection**
- **HDMI Connector Protection**
- **Notebooks**
- **PDA's**
- **GPS Devices**
- **MP3 Players**
- **Peripheral Ports**

DESCRIPTION

The TPS2294x load switches provide protection to systems and loads in high-current conditions. The devices contain a 400-m Ω current-limited P-channel MOSFET that can operate over an input voltage range of 1.62 V to 5.5 V. Current is prevented from flowing when the MOSFET is off. The switch is controlled by an on/off input (ON), which is capable of interfacing directly with low-voltage control signals. The TPS2294x includes thermal shutdown protection that prevents damage to the device when a continuous over-current condition causes excessive heating by turning off the switch.

When the switch current reaches the maximum limit, the TPS22941/2/3/4/5 operates in a constant-current mode to prohibit excessive currents from causing damage. TPS22941/3 has a current limit of 40 mA and TPS22942/4/5 has a current limit of 100 mA.

For the TPS22941/2/5, if the constant current condition still persists after 10ms, these parts shut off the switch and pull the fault signal pin (OC) low. The TPS22941/2/5, have an auto-restart feature that turns the switch on again after 80 ms if the ON pin is still active. A current limit condition on the TPS22943 and on the TPS22944 immediately pull the fault signal pin low (OC pin) and the part remains in the constant-current mode until the switch current falls below the current limit.

The TPS2294x is available in a SC70-5 (DCK) package. It is characterized for operation over the free-air temperature range of $-40^{\circ}C$ to $85^{\circ}C$.

Table 1. Feature List

| DEVICE | MINIMUM CURRENT LIMIT (mA) | CURRENT LIMIT BLANKING TIME (ms) | AUTO-RESTART TIME (ms) | ON PIN ACTIVITY |
|----------|----------------------------|----------------------------------|------------------------|-----------------|
| TPS22941 | 40 | 10 | 80 | Active LOW |
| TPS22942 | 100 | 10 | 80 | Active LOW |
| TPS22943 | 40 | 0 | N/A | Active HIGH |
| TPS22944 | 100 | 0 | N/A | Active HIGH |
| TPS22945 | 100 | 10 | 80 | Active HIGH |



Please be aware that an important notice concerning availability, standard warranty, and use in critical applications of Texas Instruments semiconductor products and disclaimers thereto appears at the end of this data sheet.

ORDERING INFORMATION⁽¹⁾

| T _A | PACKAGE ⁽²⁾ | | ORDERABLE PART NUMBER | TOP-SIDE MARKING ⁽³⁾ |
|----------------|------------------------|---------------|-----------------------|---------------------------------|
| -40°C to 85°C | SOT (SC70) – DCK | Tape and reel | TPS22941DCKR | 4A_ |
| | | | TPS22942DCKR | 4B_ |
| | | | TPS22943DCKR | 4C_ |
| | | | TPS22944DCKR | 4D_ |
| | | | TPS22945DCKR | 4E_ |

- (1) For the most current package and ordering information, see the Package Option Addendum at the end of this document, or see the TI web site at www.ti.com.
- (2) Package drawings, thermal data, and symbolization are available at www.ti.com/packaging.
- (3) The actual top-side marking has one additional character that designates the wafer fab/assembly site.

BLOCK DIAGRAM

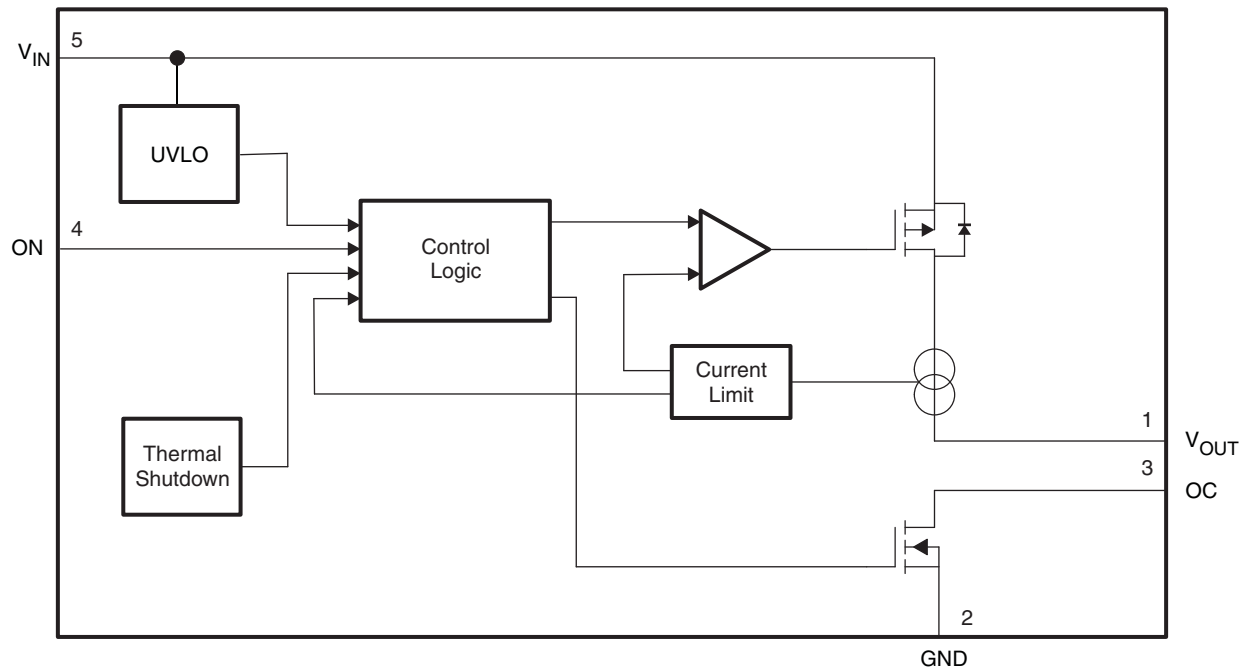

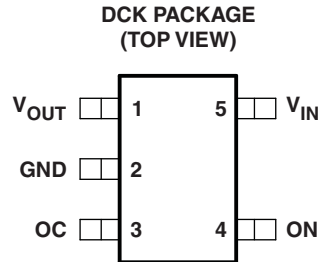
TERMINAL FUNCTIONS

| TERMINAL | | TYPE | DESCRIPTION |
|----------------------|-----------|------|--|
| SOT (DCK) PIN NO. | NAME | | |
| 1 | V_{OUT} | O | Switch output: output of the power switch |
| 2 | GND | – | Ground |
| 3 | OC | O | Over current output flag: active LOW, open drain output that indicates an over current, supply under voltage, or over temperature state. |
| 4 | ON | I | ON control input |
| 5 | V_{IN} | I | Supply input: input to the power switch and the supply voltage for the IC |
| – | DNU | – | Do not use |

ABSOLUTE MAXIMUM RATINGS⁽¹⁾

| | | | MIN | MAX | UNIT |
|------------------|--------------------------------------|---|------|-----|------|
| V _I | Input voltage range | V _{IN} , V _{OUT} , ON | -0.3 | 6 | V |
| T _J | Operating junction temperature range | | -40 | 125 | °C |
| T _{stg} | Storage temperature range | | -65 | 150 | °C |
| ESD | Electrostatic discharge protection | Human-Body Model (HBM) | | 4 | kV |
| | | Charged-Device Model (CDM) | | 1 | |

(1) Stresses beyond those listed under absolute maximum ratings may cause permanent damage to the device. These are stress ratings only, and functional operation of the device at these or any other conditions beyond those indicated under *Recommended Operating Conditions* is not implied. Exposure to absolute-maximum-rated conditions for extended periods may affect device reliability.

THERMAL IMPEDANCE RATINGS

| | | | UNIT |
|-----------------|--|-------------|----------|
| θ _{JA} | Package thermal impedance ⁽¹⁾ | DCK package | 259 °C/W |

(1) The package thermal impedance is calculated in accordance with JESD 51-7.

RECOMMENDED OPERATING CONDITIONS

| | | MIN | MAX | UNIT |
|------------------|------------------------------|------|-----------------|------|
| V _{IN} | Input voltage | 1.62 | 5.5 | V |
| V _{OUT} | Output voltage | | V _{IN} | |
| T _A | Ambient free-air temperature | -40 | 85 | °C |

ELECTRICAL CHARACTERISTICS

V_{IN} = 1.62 V to 5.5 V, T_A = -40°C to 85°C (unless otherwise noted)

| PARAMETER | TEST CONDITIONS | T _A | MIN | TYP ⁽¹⁾ | MAX | UNIT | |
|---------------------------|--|----------------|-----|--------------------|-----|------|----|
| I _{IN} | Quiescent current I _{OUT} = 0 mA, V _{IN} = 1.62 V to 5.5 V | Full | | 40 | 80 | µA | |
| I _{IN(OFF)} | OFF-State supply current V _{ON} = 0 V (TPS22943/4/5) or V _{ON} = V _{IN} (TPS22941/2) V _{IN} = 3.6 V, V _{OUT} open | Full | | | 1 | µA | |
| I _{OUT(LEAKAGE)} | OFF-State switch current V _{ON} = 0 V (TPS22943/4/5) or V _{ON} = V _{IN} (TPS22941/2) V _{IN} = 3.6 V, V _{OUT} short to GND | Full | | | 1 | µA | |
| r _{ON} | ON-state resistance I _{OUT} = 20 mA | 25°C | | 0.4 | 0.5 | Ω | |
| | | Full | | | 0.6 | | |
| | | 25°C | | 0.5 | 0.6 | | |
| | | Full | | | 0.7 | | |
| | | 25°C | | 0.6 | 0.7 | | |
| | | Full | | | 0.8 | | |
| | | 25°C | | 0.8 | 0.9 | | |
| | | Full | | | 1.1 | | |
| I _{ON} | ON input leakage current V _{ON} = V _{IN} or GND | Full | | | 1 | µA | |
| I _{LIM} | Current limit V _{IN} = 3.3 V, V _{OUT} = 3 V | TPS22941/3 | | 40 | 65 | 80 | mA |
| | | TPS22942/4/5 | | 100 | 150 | 200 | |
| Thermal shutdown | Shutdown threshold | Full | | 140 | | °C | |
| | Return from shutdown | | | 130 | | | |
| | Hysteresis | | | 10 | | | |

(1) Typical values are at V_{IN} = 3.3 V and T_A = 25°C.

ELECTRICAL CHARACTERISTICS (continued)
 $V_{IN} = 1.62\text{ V to }5.5\text{ V}$, $T_A = -40^\circ\text{C to }85^\circ\text{C}$ (unless otherwise noted)

| PARAMETER | | TEST CONDITIONS | T_A | MIN | TYP ⁽¹⁾ | MAX | UNIT |
|----------------------------|--|---|-------|------|--------------------|------|---------------|
| UVLO | Undervoltage shutdown | V_{IN} increasing | Full | 1.32 | 1.42 | 1.52 | V |
| | Undervoltage shutdown hysteresis | | Full | | 45 | | mV |
| Control Output (OC) | | | | | | | |
| Vol | OC output logic low voltage | $V_{IN} = 5\text{ V}$, $I_{SINK} = 10\text{ mA}$ | Full | | 0.1 | 0.2 | V |
| | | $V_{IN} = 1.8\text{ V}$, $I_{SINK} = 10\text{ mA}$ | | | 0.1 | 0.3 | |
| IoZ | OC output high leakage current voltage | $V_{IN} = 5\text{ V}$, Switch ON | Full | | | 0.5 | μA |
| Control Input (ON) | | | | | | | |
| Vih | ON high-level input voltage | $V_{IN} = 1.8\text{ V}$ | Full | 1.1 | | | V |
| | | $V_{IN} = 2.5\text{ V}$ | Full | 1.3 | | | V |
| | | $V_{IN} = 3.3\text{ V}$ | Full | 1.4 | | | V |
| | | $V_{IN} = 5.5\text{ V}$ | Full | 1.7 | | | V |
| Vil | ON low-level input voltage | $V_{IN} = 1.8\text{ V}$ | Full | | | 0.5 | V |
| | | $V_{IN} = 2.5\text{ V}$ | Full | | | 0.7 | V |
| | | $V_{IN} = 3.3\text{ V}$ | Full | | | 0.8 | V |
| | | $V_{IN} = 5.5\text{ V}$ | Full | | | 0.9 | V |
| li | ON high-level input leakage current | $V_{IN} = 1.8\text{ V to }5\text{ V}$, Switch ON | Full | | | 1 | μA |

SWITCHING CHARACTERISTICS
 $V_{IN} = 3.3\text{ V}$, $R_L = 500\ \Omega$, $C_L = 0.1\ \mu\text{F}$, $T_A = 25^\circ\text{C}$ (unless otherwise noted)

| PARAMETER | | TEST CONDITIONS | MIN | TYP | MAX | UNIT |
|--------------|-----------------------------|---|-----|-----|-----|---------------|
| t_{ON} | Turn-ON time | $R_L = 500\ \Omega$, $C_L = 0.1\ \mu\text{F}$ | | 60 | | μs |
| t_{OFF} | Turn-OFF time | $R_L = 500\ \Omega$, $C_L = 0.1\ \mu\text{F}$ | | 30 | | μs |
| t_r | V_{OUT} rise time | $R_L = 500\ \Omega$, $C_L = 0.1\ \mu\text{F}$ | | 10 | | μs |
| t_f | V_{OUT} fall time | $R_L = 500\ \Omega$, $C_L = 0.1\ \mu\text{F}$ | | 90 | | μs |
| t_{BLANK} | Over current blanking time | TPS22941/2/5 | 5 | 10 | 20 | ms |
| t_{RSTART} | Auto-restart time | TPS22941/2/5 | 40 | 80 | 160 | ms |
| | Short-circuit response time | $V_{IN} = V_{ON} = 3.3\text{ V}$, moderate overcurrent condition | | 9 | | μs |
| | | $V_{IN} = V_{ON} = 3.3\text{ V}$, hard short | | 4 | | μs |

TYPICAL PERFORMANCE

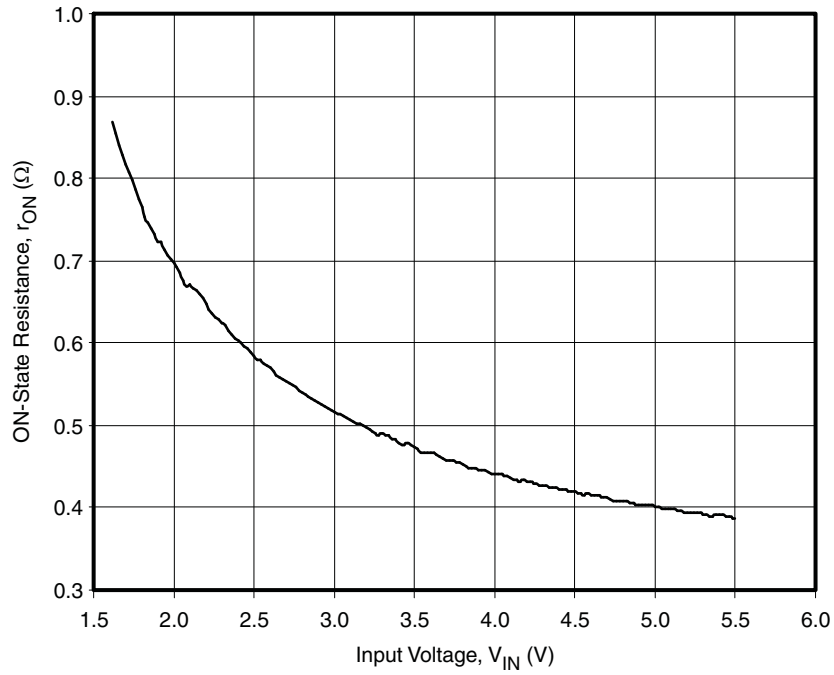

Figure 1. r_{ON} vs V_{IN}

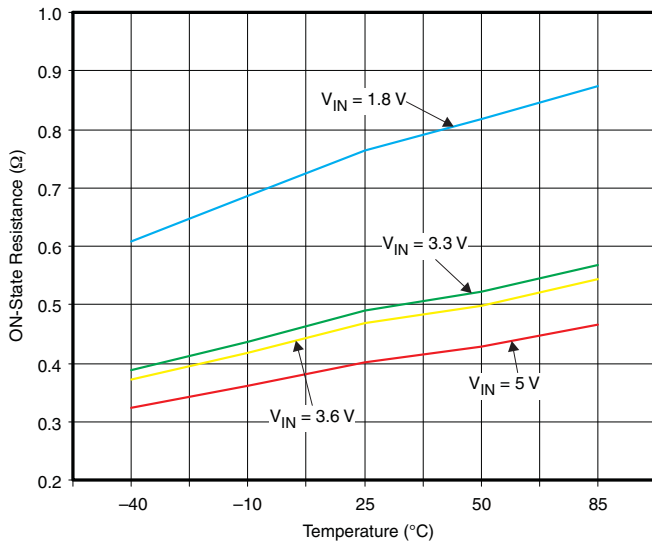

Figure 2. r_{ON} vs Temperature

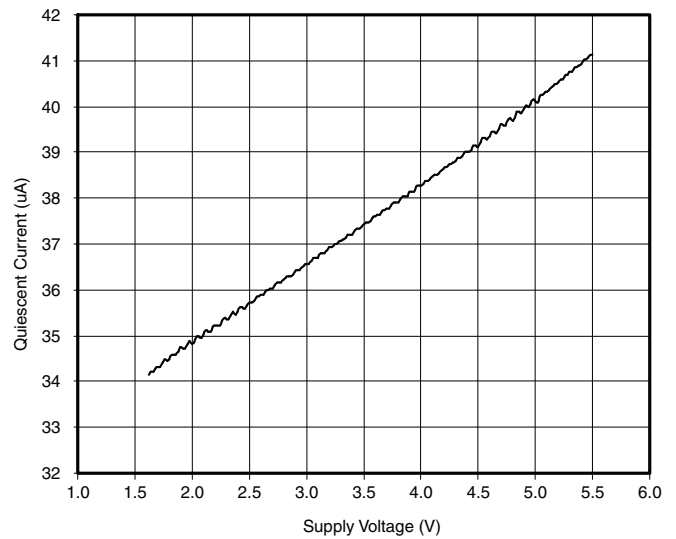

Figure 3. Quiescent Current vs V_{IN}

TYPICAL PERFORMANCE (continued)

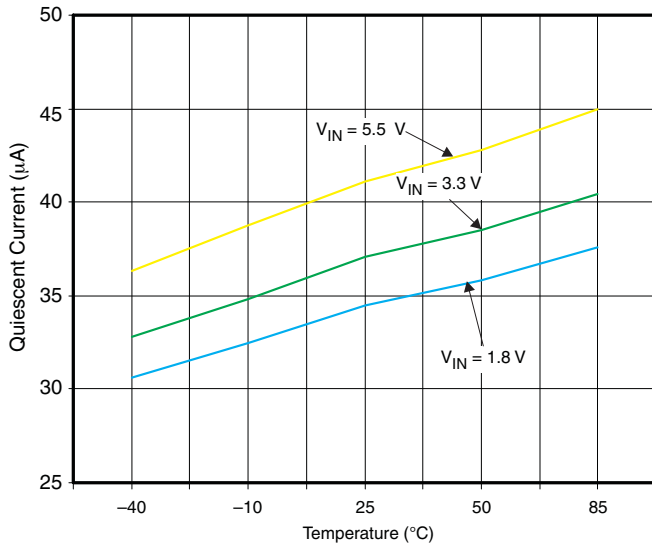

Figure 4. Quiescent Current vs Temperature

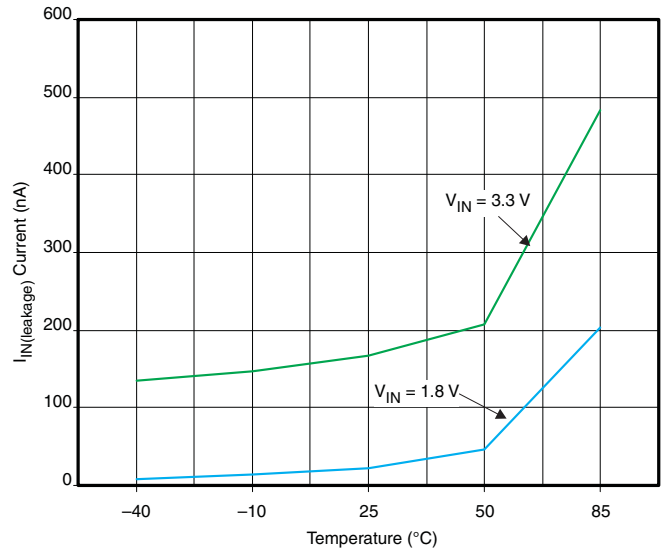

Figure 5. $I_{IN(leakage)}$ vs Temperature

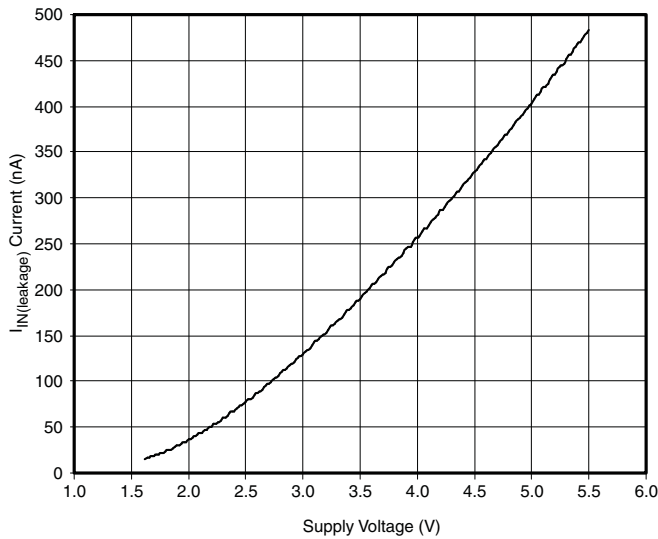

Figure 6. $I_{IN(Leakage)}$ vs V_{IN}

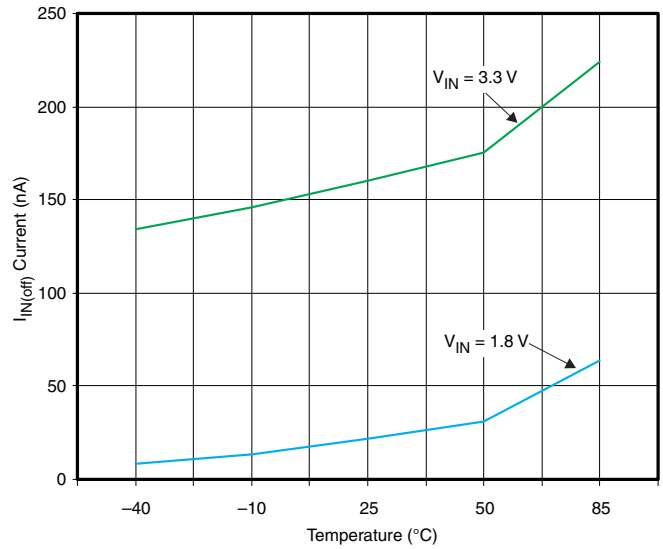

Figure 7. $I_{IN(off)}$ vs Temperature

TYPICAL PERFORMANCE (continued)

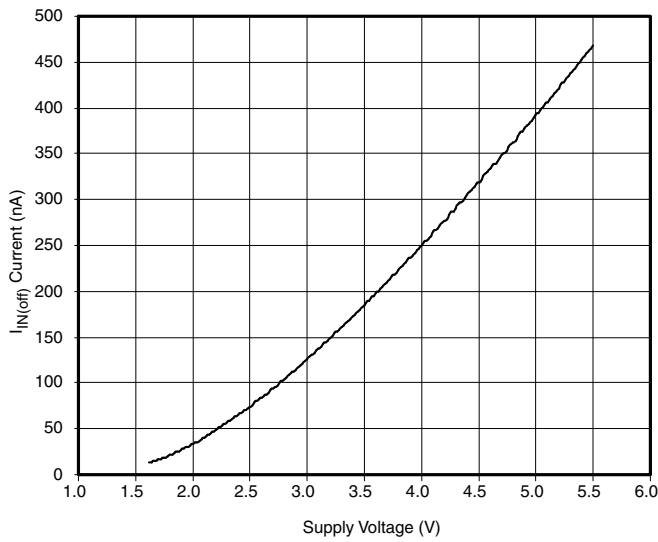

Figure 8. $I_{IN(off)}$ vs V_{IN}

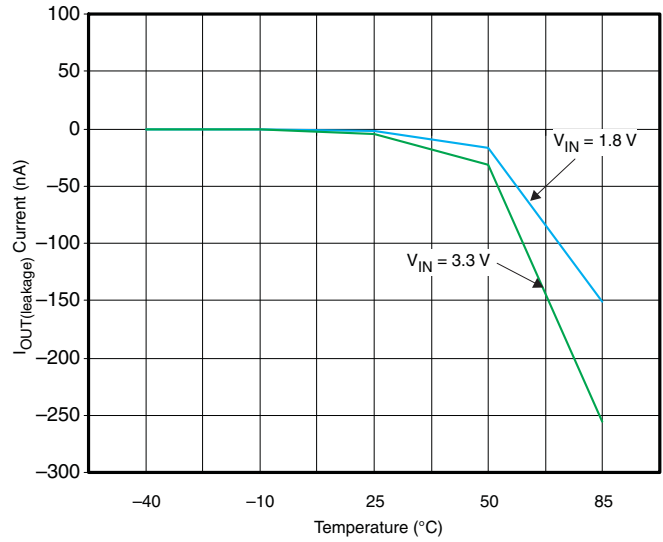

Figure 9. $I_{OUT(leakage)}$ vs Temperature

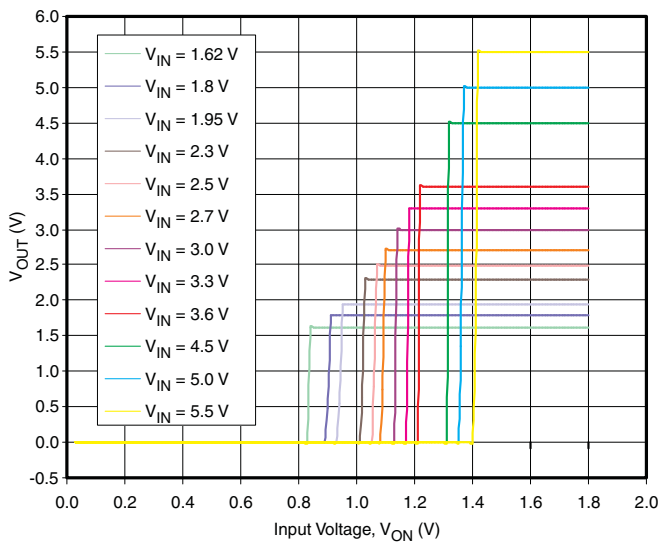

Figure 10. ON Threshold

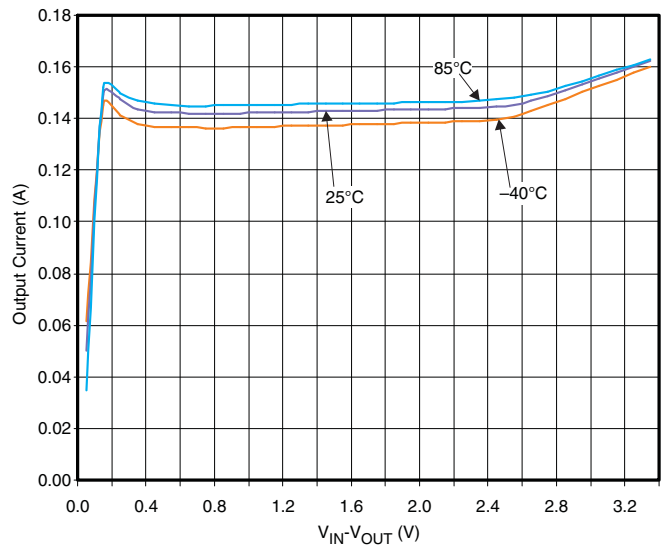

Figure 11. I_{LIM} vs Output Voltage (TPS22942, TPS22944, TPS22945)

TYPICAL PERFORMANCE (continued)

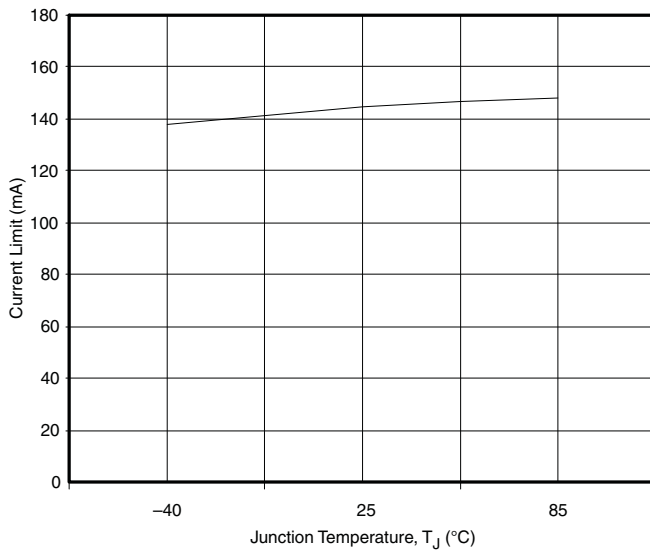

Figure 12. I_{LIM} vs Temperature (TPS22942, TPS22944, TPS22945)

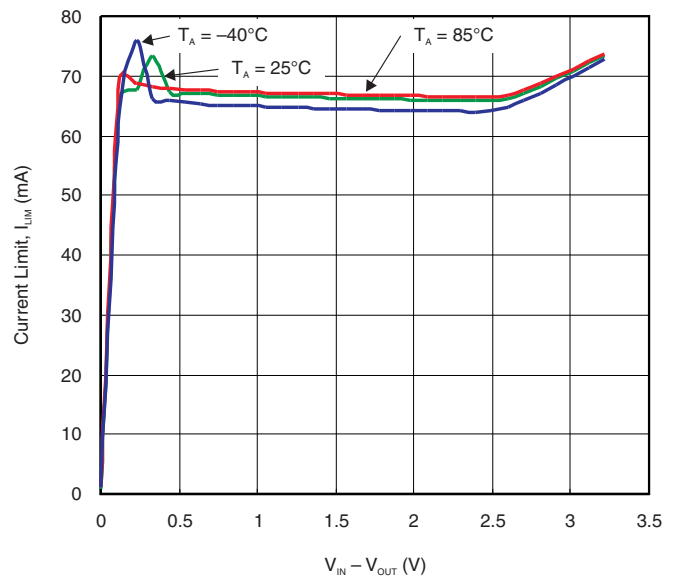

Figure 13. I_{LIM} vs Output Voltage (TPS22941, TPS22943)

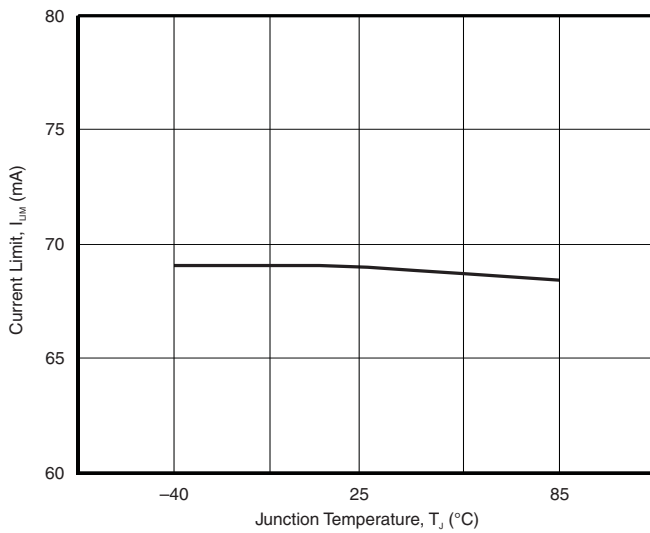

Figure 14. I_{LIM} vs Temperature (TPS22941, TPS22943)

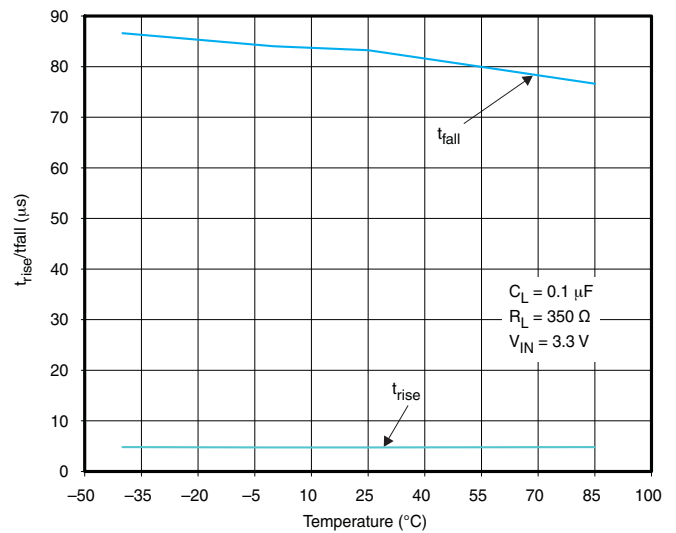

Figure 15. t_{rise}/t_{fall}

TYPICAL PERFORMANCE (continued)

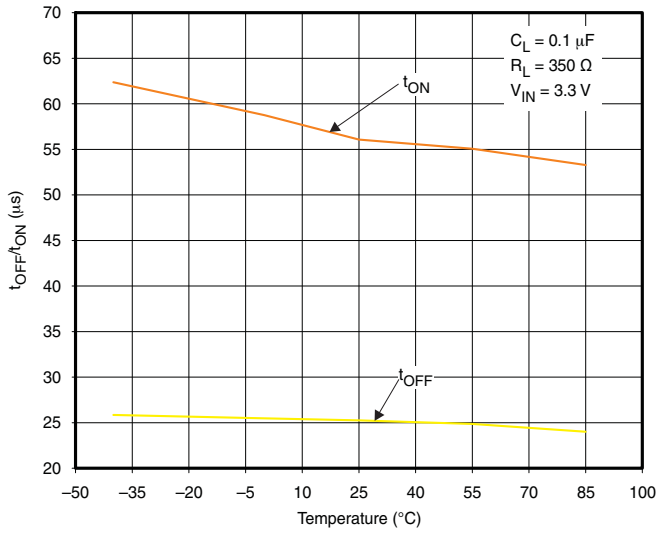

Figure 16. t_{ON}/t_{OFF}

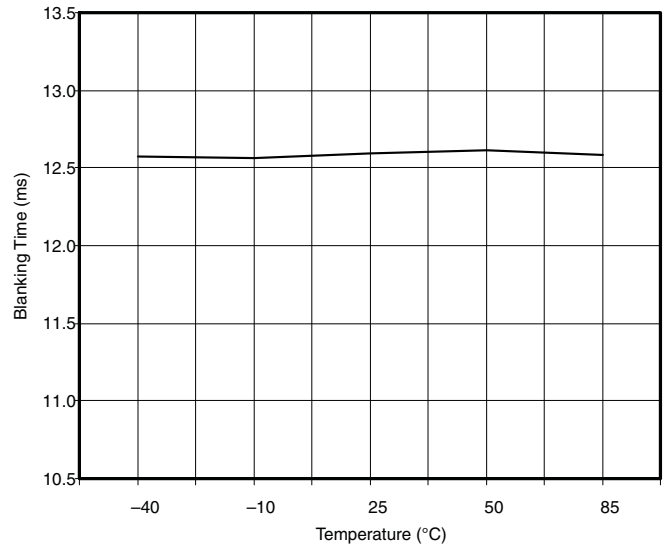

Figure 17. t_{BLANK} vs Temperature ($V_{IN} = 3.3 V$)

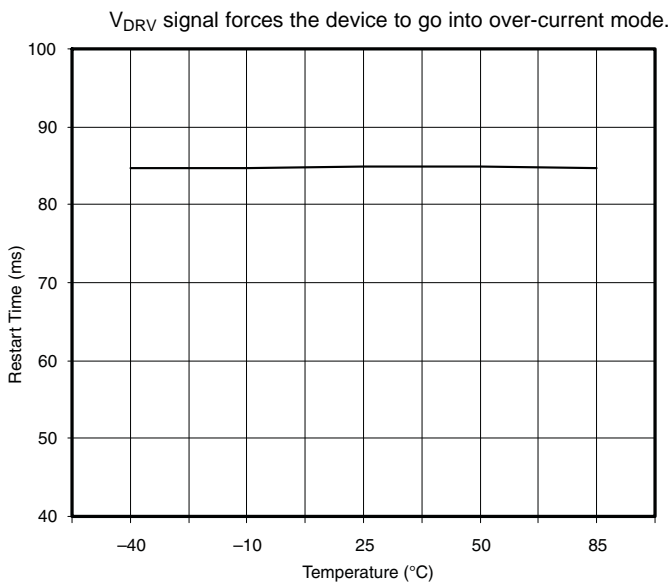

Figure 18. $t_{RESTART}$ vs Temperature ($V_{IN} = 3.3 V$)

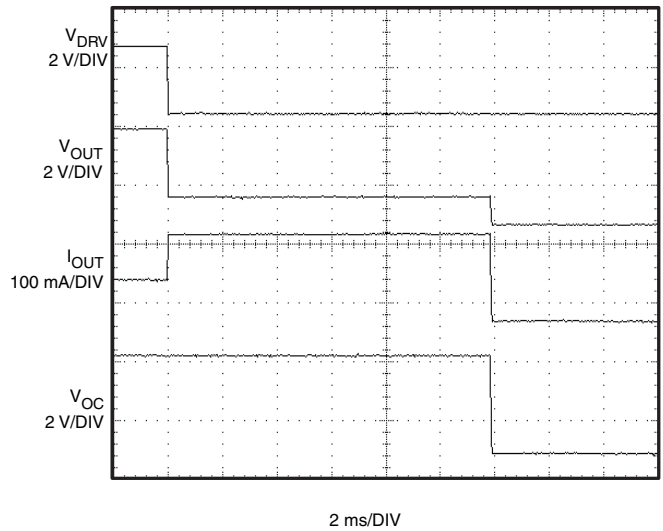

Figure 19. t_{BLANK} Response

V_{DRV} signal forces the device to go into over-current mode.

TYPICAL PERFORMANCE (continued)

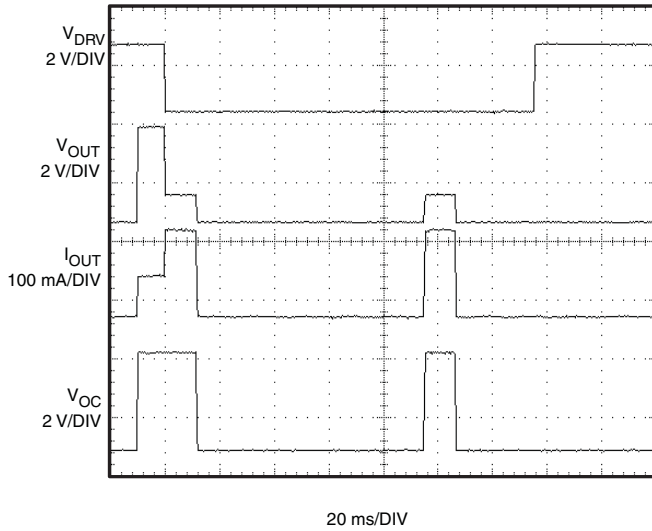

Figure 20. $t_{RESTART}$ Response

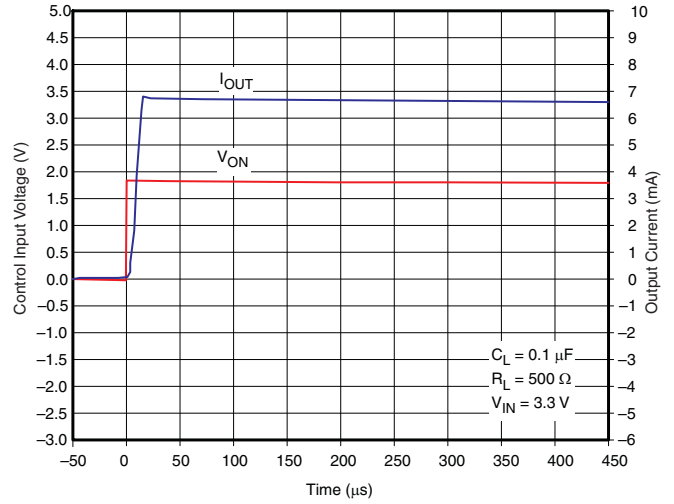

Figure 21. t_{ON} Response

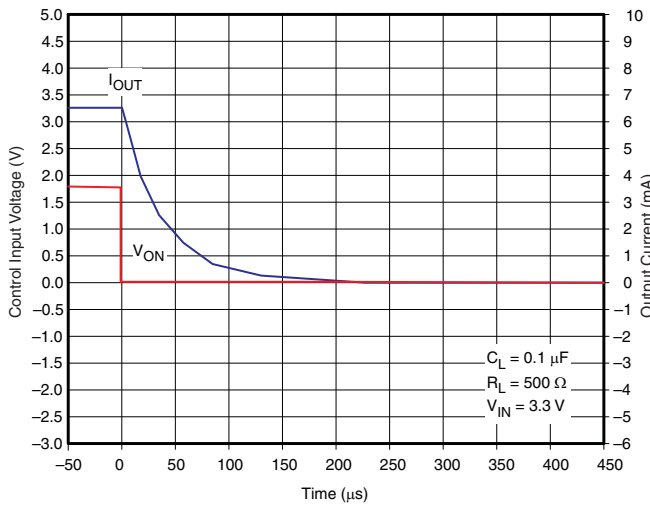

Figure 22. t_{ON} Response

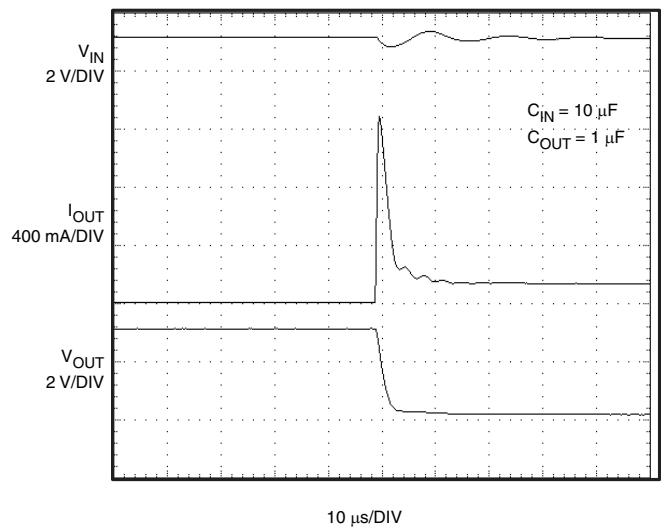

Figure 23. Short-Circuit Response Time (Output Shorted to Ground)

TYPICAL PERFORMANCE (continued)

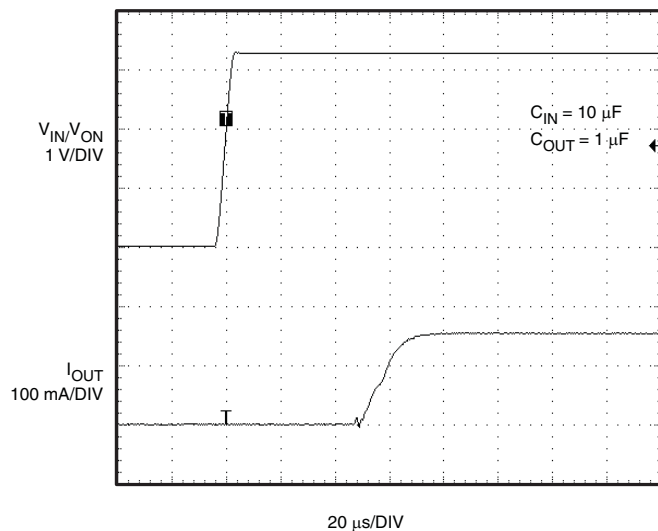

Figure 24. Short-Circuit Response Time (Switch Powerup to Hard Short)

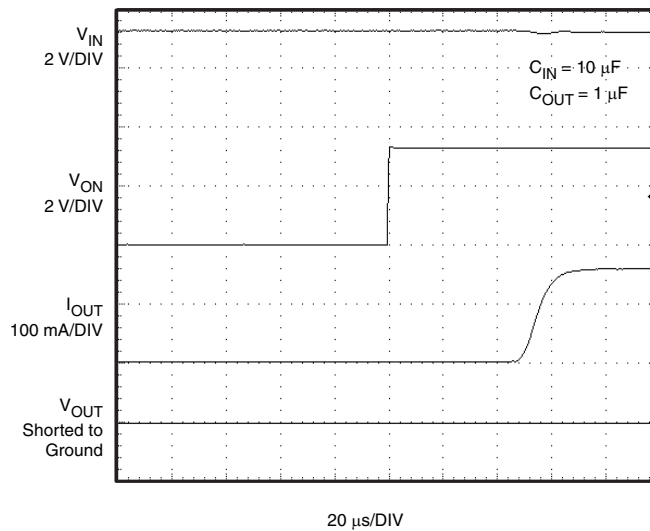

Figure 25. Current Limit Response Time

APPLICATION INFORMATION

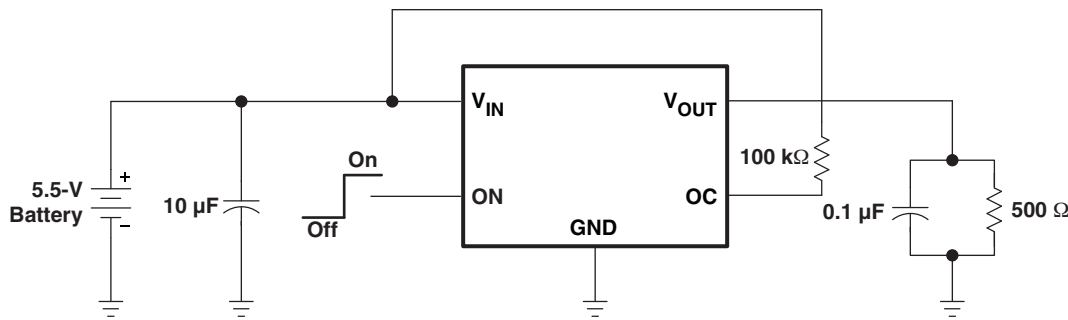

Figure 26. Typical Application Circuit, Active-High Enabled Device (TPS22943, TPS22944 and TPS22945 Only)

On/Off Control

The ON pin controls the state of the switch. Activating ON continuously holds the switch in the on state as long as there is no fault. An undervoltage on V_{IN} or a junction temperature in excess of 150°C overrides the ON control to turn off the switch. ON is active high and has a low threshold, making it capable of interfacing with low-voltage signals.

Undervoltage Lockout

The undervoltage lockout turns off the switch if the input voltage (V_{IN}) drops below the undervoltage lockout threshold. With the ON pin active, the input voltage rising above the undervoltage lockout threshold causes a controlled turn-on of the switch, which limits current overshoots.

Thermal Shutdown

Thermal shutdown protects the part from internally or externally generated excessive temperatures. During an overtemperature condition the switch is turned off. The switch automatically turns on again if the temperature of the die drops below the threshold temperature.

Reverse Voltage

If the voltage at the V_{OUT} pin is larger than the V_{IN} pin, large currents may flow and can cause permanent damage to the device. TPS2294x is designed to control current flow only from V_{IN} to V_{OUT} .

Fault Reporting

When an overcurrent, input undervoltage, or overtemperature condition is detected, OC is set active low to signal the fault mode. OC is an open-drain MOSFET and requires a pullup resistor between V_{IN} and OC. During shutdown, the pulldown on OC is disabled, reducing current draw from the supply.

Current Limiting

When the switch current reaches the maximum limit, the TPS22921/2/3/4/5 operates in a constant-current mode to prohibit excessive currents from causing damage. TPS22921/3 has a current limit of 40 mA and TPS22922/4/5 has a current limit of 100 mA. A current limit condition immediately pulls the fault signal pin low (OC pin), and the part remains in the constant-current mode until the switch current falls below the current limit.

Input Capacitor

To limit the voltage drop on the input supply caused by transient in-rush currents when the switch turns-on into a discharged load capacitor or a short-circuit, a capacitor needs to be placed between V_{IN} and GND. A 1-µF ceramic capacitor, C_{IN} , placed close to the pins is usually sufficient. Higher values of C_{IN} can be used to further reduce the voltage drop.

Output Capacitor

A 0.1- μ F capacitor, C_{OUT} , should be placed between V_{OUT} and GND. This capacitor will prevent parasitic board inductances from forcing V_{OUT} below GND when the switch turns off. For the TPS2294x, the total output capacitance needs to be kept below a maximum value, $C_{OUT(max)}$, to prevent the part from registering an over-current condition and turning-off the switch. The maximum output capacitance can be determined from the following formula, $C_{OUT} = I_{LIM(MAX)} \times t_{BLANK(MIN)} \div V_{IN}$

Due to the integral body diode in the PMOS switch, a C_{IN} greater than C_{OUT} is highly recommended. A C_{OUT} greater than C_{IN} can cause V_{OUT} to exceed V_{IN} when the system supply is removed. This could result in current flow through the body diode from V_{OUT} to V_{IN} .

Power Dissipation

During normal operation as a switch, the power dissipation is small and has little effect on the operating temperature of the part. The parts with the higher current limits will dissipate the most power and that will only be,

$$P = (I_{LIM})^2 \times r_{ON} = (0.2)^2 \times 0.4 = 16 \text{ mW when } V_{IN} = 5.5 \text{ V}$$

If the part goes into current limit the maximum power dissipation will occur when the output is shorted to ground. For TPS22941/2/5, the power dissipation scales by the auto-restart time ($t_{RESTART}$) and the overcurrent blanking time (t_{BLANK}) so that the maximum power dissipated is:

$$P(max) = (t_{BLANK} \div (t_{RESTART} + t_{BLANK})) \times (V_{IN(max)}) \times I_{LIM(max)} = (10 \div (80 + 10)) \times 5.5 \times 0.2 = 122 \text{ mW}$$

When using the TPS22943 and TPS22944, a short on the output causes the part to operate in a constant current state, dissipating a worst-case power as calculated above until the thermal shutdown activates. It then cycles in and out of thermal shutdown so long as the ON pin is active and the short is present.

Board Layout

For best performance, all traces should be as short as possible. To be most effective, the input and output capacitors should be placed close to the device to minimize the effects that parasitic trace inductances may have on normal and short-circuit operation. Using wide traces for V_{IN} , V_{OUT} , and GND will help minimize parasitic electrical effects along with minimizing the case to ambient thermal impedance.

PACKAGING INFORMATION

| Orderable Device | Status ⁽¹⁾ | Package Type | Package Drawing | Pins | Package Qty | Eco Plan ⁽²⁾ | Lead/Ball Finish | MSL Peak Temp ⁽³⁾ |
|------------------|-----------------------|--------------|-----------------|------|-------------|-------------------------|------------------|------------------------------|
| TPS22941DCKR | ACTIVE | SC70 | DCK | 5 | 3000 | Green (RoHS & no Sb/Br) | CU NIPDAU | Level-1-260C-UNLIM |
| TPS22942DCKR | ACTIVE | SC70 | DCK | 5 | 3000 | Green (RoHS & no Sb/Br) | CU NIPDAU | Level-1-260C-UNLIM |
| TPS22942DCKRG4 | ACTIVE | SC70 | DCK | 5 | 3000 | Green (RoHS & no Sb/Br) | CU NIPDAU | Level-1-260C-UNLIM |
| TPS22943DCKR | ACTIVE | SC70 | DCK | 5 | 3000 | Green (RoHS & no Sb/Br) | CU NIPDAU | Level-1-260C-UNLIM |
| TPS22944DCKR | ACTIVE | SC70 | DCK | 5 | 3000 | Green (RoHS & no Sb/Br) | CU NIPDAU | Level-1-260C-UNLIM |
| TPS22945DCKR | ACTIVE | SC70 | DCK | 5 | 3000 | Green (RoHS & no Sb/Br) | CU NIPDAU | Level-1-260C-UNLIM |
| TPS22945DCKRG4 | ACTIVE | SC70 | DCK | 5 | 3000 | Green (RoHS & no Sb/Br) | CU NIPDAU | Level-1-260C-UNLIM |

⁽¹⁾ The marketing status values are defined as follows:

ACTIVE: Product device recommended for new designs.

LIFEBUY: TI has announced that the device will be discontinued, and a lifetime-buy period is in effect.

NRND: Not recommended for new designs. Device is in production to support existing customers, but TI does not recommend using this part in a new design.

PREVIEW: Device has been announced but is not in production. Samples may or may not be available.

OBSELETE: TI has discontinued the production of the device.

⁽²⁾ Eco Plan - The planned eco-friendly classification: Pb-Free (RoHS), Pb-Free (RoHS Exempt), or Green (RoHS & no Sb/Br) - please check <http://www.ti.com/productcontent> for the latest availability information and additional product content details.

TBD: The Pb-Free/Green conversion plan has not been defined.

Pb-Free (RoHS): TI's terms "Lead-Free" or "Pb-Free" mean semiconductor products that are compatible with the current RoHS requirements for all 6 substances, including the requirement that lead not exceed 0.1% by weight in homogeneous materials. Where designed to be soldered at high temperatures, TI Pb-Free products are suitable for use in specified lead-free processes.

Pb-Free (RoHS Exempt): This component has a RoHS exemption for either 1) lead-based flip-chip solder bumps used between the die and package, or 2) lead-based die adhesive used between the die and leadframe. The component is otherwise considered Pb-Free (RoHS compatible) as defined above.

Green (RoHS & no Sb/Br): TI defines "Green" to mean Pb-Free (RoHS compatible), and free of Bromine (Br) and Antimony (Sb) based flame retardants (Br or Sb do not exceed 0.1% by weight in homogeneous material)

⁽³⁾ MSL, Peak Temp. -- The Moisture Sensitivity Level rating according to the JEDEC industry standard classifications, and peak solder temperature.

Important Information and Disclaimer:The information provided on this page represents TI's knowledge and belief as of the date that it is provided. TI bases its knowledge and belief on information provided by third parties, and makes no representation or warranty as to the accuracy of such information. Efforts are underway to better integrate information from third parties. TI has taken and continues to take reasonable steps to provide representative and accurate information but may not have conducted destructive testing or chemical analysis on incoming materials and chemicals. TI and TI suppliers consider certain information to be proprietary, and thus CAS numbers and other limited information may not be available for release.

In no event shall TI's liability arising out of such information exceed the total purchase price of the TI part(s) at issue in this document sold by TI to Customer on an annual basis.

TAPE AND REEL INFORMATION

QUADRANT ASSIGNMENTS FOR PIN 1 ORIENTATION IN TAPE

*All dimensions are nominal

| Device | Package Type | Package Drawing | Pins | SPQ | Reel Diameter (mm) | Reel Width W1 (mm) | A0 (mm) | B0 (mm) | K0 (mm) | P1 (mm) | W (mm) | Pin1 Quadrant |
|--------------|--------------|-----------------|------|------|--------------------|--------------------|---------|---------|---------|---------|--------|---------------|
| TPS22941DCKR | SC70 | DCK | 5 | 3000 | 180.0 | 9.2 | 2.24 | 2.34 | 1.22 | 4.0 | 8.0 | Q3 |
| TPS22942DCKR | SC70 | DCK | 5 | 3000 | 180.0 | 9.2 | 2.24 | 2.34 | 1.22 | 4.0 | 8.0 | Q3 |
| TPS22942DCKR | SC70 | DCK | 5 | 3000 | 179.0 | 8.4 | 2.2 | 2.5 | 1.2 | 4.0 | 8.0 | Q3 |
| TPS22945DCKR | SC70 | DCK | 5 | 3000 | 179.0 | 8.4 | 2.2 | 2.5 | 1.2 | 4.0 | 8.0 | Q3 |
| TPS22945DCKR | SC70 | DCK | 5 | 3000 | 180.0 | 9.2 | 2.24 | 2.34 | 1.22 | 4.0 | 8.0 | Q3 |

TAPE AND REEL BOX DIMENSIONS

*All dimensions are nominal

| Device | Package Type | Package Drawing | Pins | SPQ | Length (mm) | Width (mm) | Height (mm) |
|--------------|--------------|-----------------|------|------|-------------|------------|-------------|
| TPS22941DCKR | SC70 | DCK | 5 | 3000 | 205.0 | 200.0 | 33.0 |
| TPS22942DCKR | SC70 | DCK | 5 | 3000 | 205.0 | 200.0 | 33.0 |
| TPS22942DCKR | SC70 | DCK | 5 | 3000 | 203.0 | 203.0 | 35.0 |
| TPS22945DCKR | SC70 | DCK | 5 | 3000 | 203.0 | 203.0 | 35.0 |
| TPS22945DCKR | SC70 | DCK | 5 | 3000 | 205.0 | 200.0 | 33.0 |

DCK (R-PDSO-G5)

PLASTIC SMALL-OUTLINE PACKAGE



- NOTES:
- A. All linear dimensions are in millimeters.
 - B. This drawing is subject to change without notice.
 - C. Body dimensions do not include mold flash or protrusion. Mold flash and protrusion shall not exceed 0.15 per side.
 - D. Falls within JEDEC MO-203 variation AA.

IMPORTANT NOTICE

Texas Instruments Incorporated and its subsidiaries (TI) reserve the right to make corrections, modifications, enhancements, improvements, and other changes to its products and services at any time and to discontinue any product or service without notice. Customers should obtain the latest relevant information before placing orders and should verify that such information is current and complete. All products are sold subject to TI's terms and conditions of sale supplied at the time of order acknowledgment.

TI warrants performance of its hardware products to the specifications applicable at the time of sale in accordance with TI's standard warranty. Testing and other quality control techniques are used to the extent TI deems necessary to support this warranty. Except where mandated by government requirements, testing of all parameters of each product is not necessarily performed.

TI assumes no liability for applications assistance or customer product design. Customers are responsible for their products and applications using TI components. To minimize the risks associated with customer products and applications, customers should provide adequate design and operating safeguards.

TI does not warrant or represent that any license, either express or implied, is granted under any TI patent right, copyright, mask work right, or other TI intellectual property right relating to any combination, machine, or process in which TI products or services are used. Information published by TI regarding third-party products or services does not constitute a license from TI to use such products or services or a warranty or endorsement thereof. Use of such information may require a license from a third party under the patents or other intellectual property of the third party, or a license from TI under the patents or other intellectual property of TI.

Reproduction of TI information in TI data books or data sheets is permissible only if reproduction is without alteration and is accompanied by all associated warranties, conditions, limitations, and notices. Reproduction of this information with alteration is an unfair and deceptive business practice. TI is not responsible or liable for such altered documentation. Information of third parties may be subject to additional restrictions.

Resale of TI products or services with statements different from or beyond the parameters stated by TI for that product or service voids all express and any implied warranties for the associated TI product or service and is an unfair and deceptive business practice. TI is not responsible or liable for any such statements.

TI products are not authorized for use in safety-critical applications (such as life support) where a failure of the TI product would reasonably be expected to cause severe personal injury or death, unless officers of the parties have executed an agreement specifically governing such use. Buyers represent that they have all necessary expertise in the safety and regulatory ramifications of their applications, and acknowledge and agree that they are solely responsible for all legal, regulatory and safety-related requirements concerning their products and any use of TI products in such safety-critical applications, notwithstanding any applications-related information or support that may be provided by TI. Further, Buyers must fully indemnify TI and its representatives against any damages arising out of the use of TI products in such safety-critical applications.

TI products are neither designed nor intended for use in military/aerospace applications or environments unless the TI products are specifically designated by TI as military-grade or "enhanced plastic." Only products designated by TI as military-grade meet military specifications. Buyers acknowledge and agree that any such use of TI products which TI has not designated as military-grade is solely at the Buyer's risk, and that they are solely responsible for compliance with all legal and regulatory requirements in connection with such use.

TI products are neither designed nor intended for use in automotive applications or environments unless the specific TI products are designated by TI as compliant with ISO/TS 16949 requirements. Buyers acknowledge and agree that, if they use any non-designated products in automotive applications, TI will not be responsible for any failure to meet such requirements.

Following are URLs where you can obtain information on other Texas Instruments products and application solutions:

| Products | | Applications | |
|-----------------------------|--|----------------------------|--|
| Amplifiers | amplifier.ti.com | Audio | www.ti.com/audio |
| Data Converters | dataconverter.ti.com | Automotive | www.ti.com/automotive |
| DLP® Products | www.dlp.com | Communications and Telecom | www.ti.com/communications |
| DSP | dsp.ti.com | Computers and Peripherals | www.ti.com/computers |
| Clocks and Timers | www.ti.com/clocks | Consumer Electronics | www.ti.com/consumer-apps |
| Interface | interface.ti.com | Energy | www.ti.com/energy |
| Logic | logic.ti.com | Industrial | www.ti.com/industrial |
| Power Mgmt | power.ti.com | Medical | www.ti.com/medical |
| Microcontrollers | microcontroller.ti.com | Security | www.ti.com/security |
| RFID | www.ti-rfid.com | Space, Avionics & Defense | www.ti.com/space-avionics-defense |
| RF/IF and ZigBee® Solutions | www.ti.com/lprf | Video and Imaging | www.ti.com/video |
| | | Wireless | www.ti.com/wireless-apps |

Mailing Address: Texas Instruments, Post Office Box 655303, Dallas, Texas 75265
Copyright © 2010, Texas Instruments Incorporated