



### Industrial High Energy Metal-Oxide Varistors

The DA and DB Series transient surge suppressors are heavy-duty industrial metal-oxide varistors designed to provide surge protection for motor controls and power supplies used in oil-drilling, mining, and transportation equipment.

These UL-recognized varistors have identical ratings and specifications but differ in case construction to provide flexibility in equipment designs.

DA series devices feature rigid terminals to insure secure wire contacts. Both the DA and DB series feature improved creep and strike distance capability to minimize breakdown along the package surface design that provides complete electrical isolation of the disc subassembly.

See DA/DB Series Device Ratings and Specifications table for part number and brand information.

### Features

- Recognized as "Transient Voltage Surge Suppressors", UL File #E75961 to Std. 1449, Second Edition
- High Energy Absorption Capability  
 $W_{TM}$  ..... Up To 1050J
- Wide Operating Voltage Range  
 $V_{M(AC)RMS}$  ..... 130V to 750V
- Screw Terminals (DA Series),  
 Quick Connect Push-On Connectors (DB Series)
- Case Design Provides Complete Electrical Isolation of Disc Subassembly
- 40mm Diameter Disc
- No Derating Up to 85°C Ambient

### Packaging

DA SERIES

DB SERIES

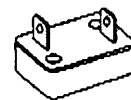
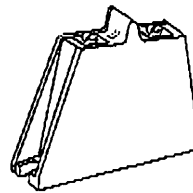

## DA/DB Series

**Absolute Maximum Ratings** For ratings of individual members of a series, see Device Ratings and Specifications chart

	DA/DB SERIES	UNITS
<b>Continuous:</b>		
Steady State Applied Voltage:		
AC Voltage Range ( $V_{M(AC)RMS}$ ) .....	130 to 750	V
DC Voltage Range ( $V_{M(DC)}$ ) .....	175 to 970	V
<b>Transient:</b>		
Peak Pulse Current ( $I_{TM}$ )		
For 8/20 $\mu$ s Current Wave (See Figure 2) .....	30,000 to 40,000	A
Single Pulse Energy Range		
For 2ms Current Square Wave ( $W_{TM}$ ) .....	270 to 1050	J
Operating Ambient Temperature Range ( $T_A$ ) .....	-55 to 85	$^{\circ}$ C
Storage Temperature Range ( $T_{STG}$ ) .....	-55 to 125	$^{\circ}$ C
Temperature Coefficient ( $\alpha_V$ ) of Clamping Voltage ( $V_C$ ) at Specified Test Current .....	<0.01	%/ $^{\circ}$ C
Hi-Pot Encapsulation (Isolation Voltage Capability) .....	5000	V
(Dielectric must withstand indicated DC voltage for one minute per MIL-STD 202, Method 301)		
Insulation Resistance .....	1000	M $\Omega$

**CAUTION:** Stresses above those listed in "Absolute Maximum Ratings" may cause permanent damage to the device. This is a stress only rating and operation of the device at these or any other conditions above those indicated in the operational sections of this specification is not implied.

### Device Ratings and Specifications

Series DA and DB Varistors are listed under UL file #E75961 as a UL recognized component.

PART NUMBER AND DEVICE BRANDING		MAXIMUM RATINGS (85 $^{\circ}$ C)				SPECIFICATIONS (25 $^{\circ}$ C)				
		CONTINUOUS		TRANSIENT		VARISTOR VOLTAGE AT 1mA DC TEST CURRENT			MAX CLAMP- ING VOLT $V_C$ AT 200A CURRENT (8/20 $\mu$ s)	TYPICAL CAPACI- TANCE
		$V_{RMS}$	$V_{DC}$	ENERGY (2ms)	PEAK CURRENT (8/20 $\mu$ s)					
		$V_{M(AC)}$	$V_{M(DC)}$	$W_{TM}$	$I_{TM}$	MIN	$V_{N(DC)}$	MAX	$V_C$	f = 1MHz
DA	DB	(V)	(V)	(J)	(A)	(V)	(V)	(V)	(V)	(pF)
V131DA40	V131DB40	130	175	270	30000	184	200	228	345	10000
V151DA40	V151DB40	150	200	300	30000	212	240	268	405	8000
V251DA40	V251DB40	250	330	370	30000	354	390	429	650	5000
V271DA40	V271DB40	275	369	400	30000	389	430	473	730	4500
V321DA40	V321DB40	320	420	460	30000	462	510	561	830	3800
V421DA40	V421DB40	420	560	600	40000	610	680	748	1130	3000
V481DA40	V481DB40	480	640	650	40000	670	750	825	1240	2700
V511DA40	V511DB40	510	675	700	40000	735	820	910	1350	2500
V571DA40	V571DB40	575	730	770	40000	805	910	1000	1480	2200
V661DA40	V661DB40	660	850	900	40000	940	1050	1160	1720	2000
V751DA40	V751DB40	750	970	1050	40000	1080	1200	1320	2000	1800

NOTE: Average power dissipation of transients not to exceed 2.0W.

### DAIDB Series

#### Power Dissipation Ratings

Should transients occur in rapid succession, the average power dissipation required is simply the energy (watt-seconds) per pulse times the number of pulses per second. The power so developed must be within the specifications shown on the Device Ratings and Specifications table for the specific device. Furthermore, the operating values need to be derated at high temperatures as shown in Figure 1. Because varistors can only dissipate a relatively small amount of average power they are, therefore, not suitable for repetitive applications that involve substantial amounts of average power dissipation.

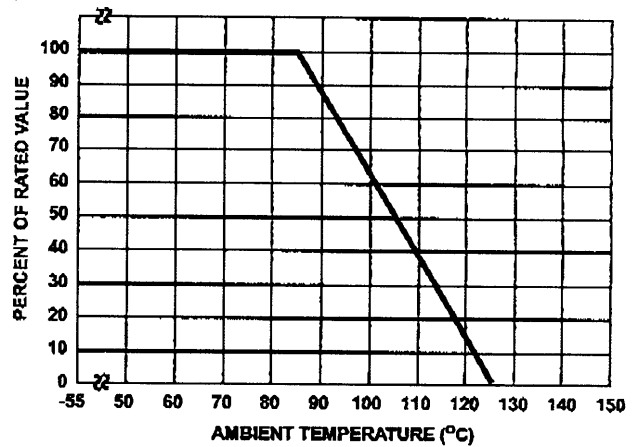
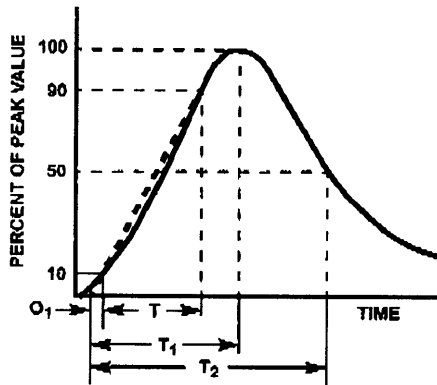

FIGURE 1. CURRENT, ENERGY AND POWER DERATING CURVE



$O_1$  = Virtual Origin of Wave  
 $T$  = Time From 10% to 90% of Peak  
 $T_1$  = Virtual Front time =  $1.25 \cdot t$   
 $T_2$  = Virtual Time to Half Value (Impulse Duration)  
 Example: For an 8/20 $\mu$ s Current Waveform:  
 $8\mu$ s =  $T_1$  = Virtual Front Time  
 $20\mu$ s =  $T_2$  = Virtual Time to Half Value

FIGURE 2. PEAK PULSE CURRENT TEST WAVEFORM

#### Transient V-I Characteristics Curve

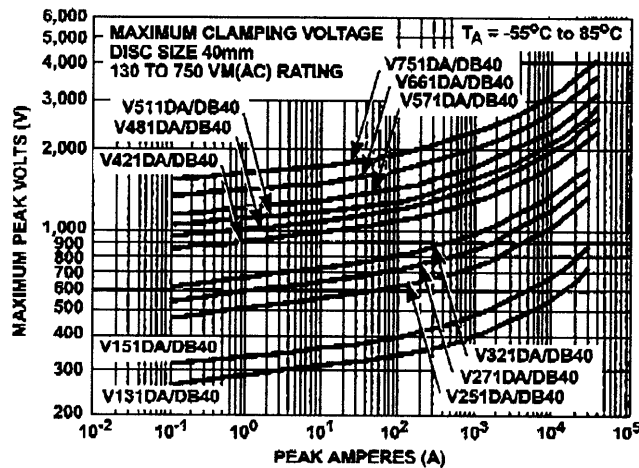

FIGURE 3. CLAMPING VOLTAGE FOR V131DA40, V131DB40 - V751DA40, V751DB40

### DA/DB Series

#### Pulse Rating Curves

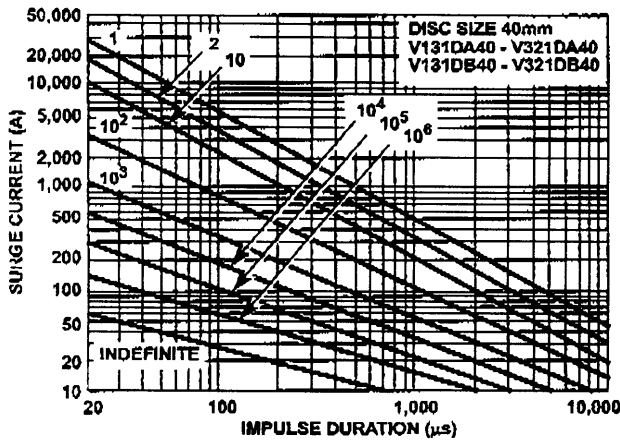

FIGURE 4. SURGE CURRENT RATING CURVES FOR V131DA40, V131DB40 - V321DA40, V321DB40

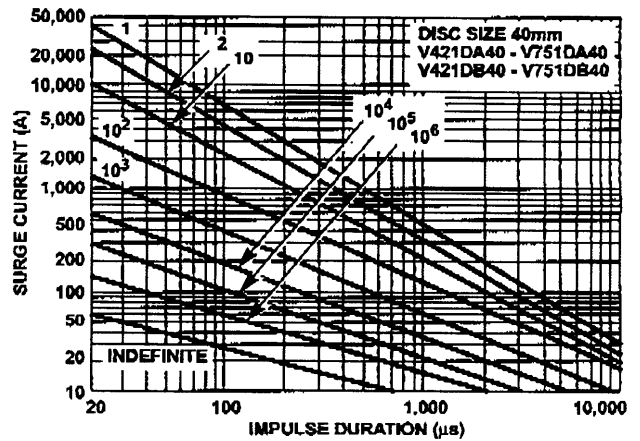

FIGURE 5. SURGE CURRENT RATING CURVES FOR V421DA40, V421DB40 - V751DA40

NOTE: If pulse ratings are exceeded, a shift of  $V_{N(DC)}$  (at specified current) of more than  $\pm 10\%$  could result. This type of shift, which normally results in a decrease of  $V_{N(DC)}$ , may result in the device not meeting the original published specifications, but it does not prevent the device from continuing to function, and to provide ample protection.

#### Mechanical Dimensions

##### DA SERIES

"A" DIMENSION:  
FILISTER HEAD SCREW - 51mm (2.01)  
PAN HEAD SCREW - 53mm (2.09)

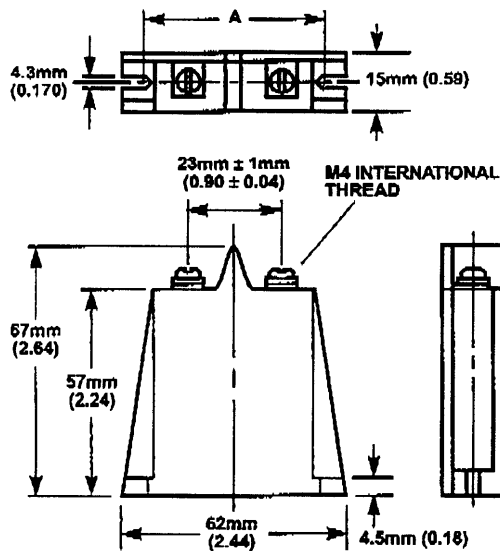

##### DB SERIES

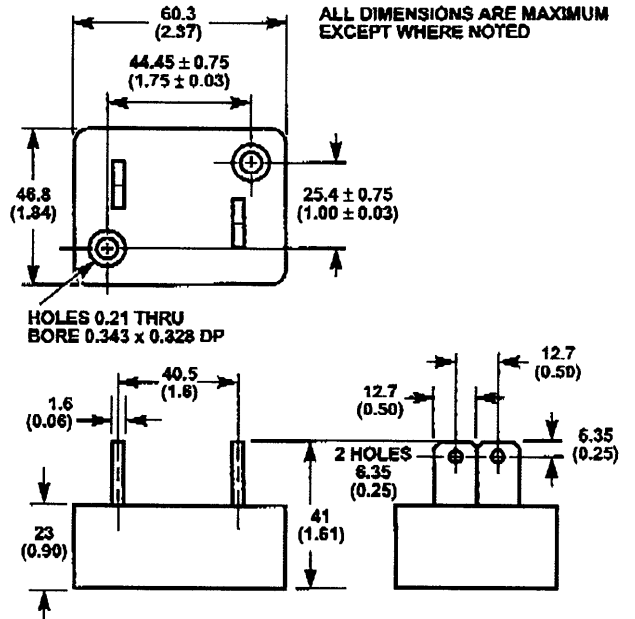

Dimensions in millimeters and (inches).

All Harris Semiconductor products are manufactured, assembled and tested under ISO9000 quality systems certification.

Harris Semiconductor products are sold by description only. Harris Semiconductor reserves the right to make changes in circuit design and/or specifications at any time without notice. Accordingly, the reader is cautioned to verify that data sheets are current before placing orders. Information furnished by Harris is believed to be accurate and reliable. However, no responsibility is assumed by Harris or its subsidiaries for its use; nor for any infringements of patents or other rights of third parties which may result from its use. No license is granted by implication or otherwise under any patent or patent rights of Harris or its subsidiaries.

For information regarding Harris Semiconductor and its products, call 1-800-4-HARRIS or see web site <http://www.semi.harris.com>