

SKT 250

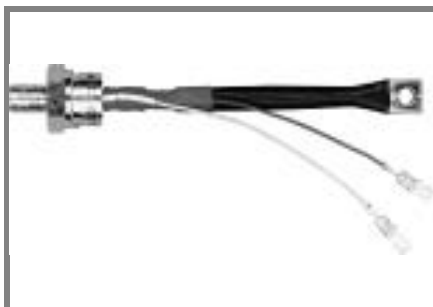

Stud Thyristor

Line Thyristor

SKT 250

Features

- Hermetic metal case with glass insulator
- Threaded stud ISO M24x1,5
- High i^2t and I_{TSM} values for easy fusing
- International standard case

Typical Applications*

- DC motor control (e. g. for machine tools)
- Controlled rectifiers (e. g. for battery charging)
- AC controllers (e. g. for temperature control)
- Recommended snubber network e. g. for $V_{VRMS} \leq 400$ V:
 $R = 33 \Omega / 32$ W, $C = 0,47 \mu F$

V_{RSM} V	V_{RRM}, V_{DRM} V	$I_{TRMS} = 450$ A (maximum value for continuous operation) $I_{TAV} = 250$ A (sin. 180; $T_c = 85$ °C)	
500	400	SKT 250/04D	
900	800	SKT 250/08D	
1300	1200	SKT 250/12E	
1500	1400	SKT 250/14E	
1700	1600	SKT 250/16E	

Symbol	Conditions	Values	Units
I_{TAV}	sin. 180; $T_c = 100$ (85) °C;	185 (250)	A
I_D	K0,55; $T_a = 45$ °C; B2 / B6	240 / 330	A
	K0,55F; $T_a = 35$ °C; B2 / B5	490 / 675	A
I_{RMS}	K0,55; $T_a = 45$ °C; W1C	265	A
I_{TSM}	$T_{vj} = 25$ °C; 10 ms	7000	A
	$T_{vj} = 130$ °C; 10 ms	6000	A
i^2t	$T_{vj} = 25$ °C; 8,35 ... 10 ms	245000	A ² s
	$T_{vj} = 130$ °C; 8,35 ... 10 ms	180000	A ² s
V_T	$T_{vj} = 25$ °C; $I_T = 800$ A	max. 1,65	V
$V_{T(TO)}$	$T_{vj} = 130$ °C	max. 1	V
r_T	$T_{vj} = 130$ °C	max. 0,7	mΩ
$I_{DD}; I_{RD}$	$T_{vj} = 130$ °C; $V_{RD} = V_{RRM}; V_{DD} = V_{DRM}$	max. 50	mA
t_{gd}	$T_{vj} = 25$ °C; $I_G = 1$ A; $di_G/dt = 1$ A/μs	1	μs
t_{gr}	$V_D = 0,67 * V_{DRM}$	2	μs
$(di/dt)_{cr}$	$T_{vj} = 130$ °C	max. 100	A/μs
$(dv/dt)_{cr}$	$T_{vj} = 130$ °C; SKT ...D / SKT ...E	max. 500 / 1000	V/μs
t_q	$T_{vj} = 130$ °C,	50 ... 150	μs
I_H	$T_{vj} = 25$ °C; typ. / max.	150 / 250	mA
I_L	$T_{vj} = 25$ °C; $R_G = 33 \Omega$; typ. / max.	300 / 600	mA
V_{GT}	$T_{vj} = 25$ °C; d.c.	min. 3	V
I_{GT}	$T_{vj} = 25$ °C; d.c.	min. 200	mA
V_{GD}	$T_{vj} = 130$ °C; d.c.	max. 0,25	V
I_{GD}	$T_{vj} = 130$ °C; d.c.	max. 10	mA
$R_{th(j-c)}$	cont.	0,11	K/W
$R_{th(j-c)}$	sin. 180	0,123	K/W
$R_{th(j-c)}$	rec. 120	0,137	K/W
$R_{th(c-s)}$		0,015	K/W
T_{vj}		- 40 ... + 130	°C
T_{stg}		- 55 ... + 150	°C
V_{isol}		-	V~
M_s	to heatsink	60	Nm
a		5 * 9,81	m/s ²
m	approx.	490	g
Case		B 7	

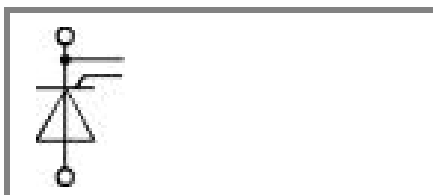

SKT

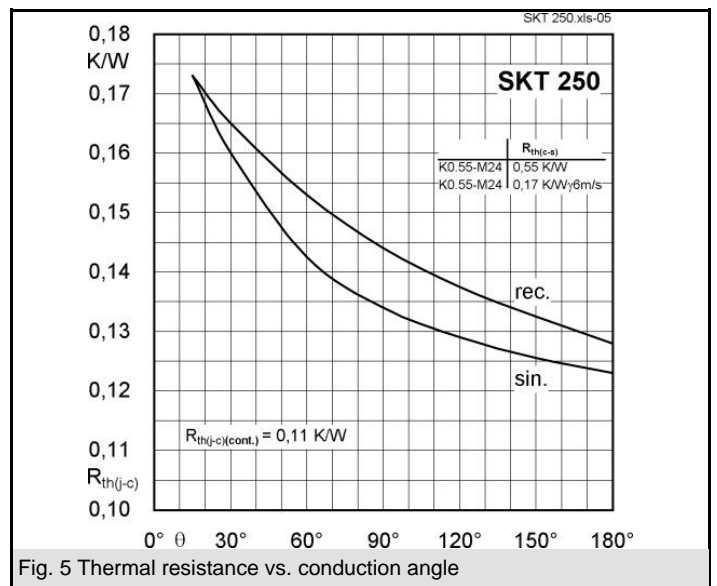
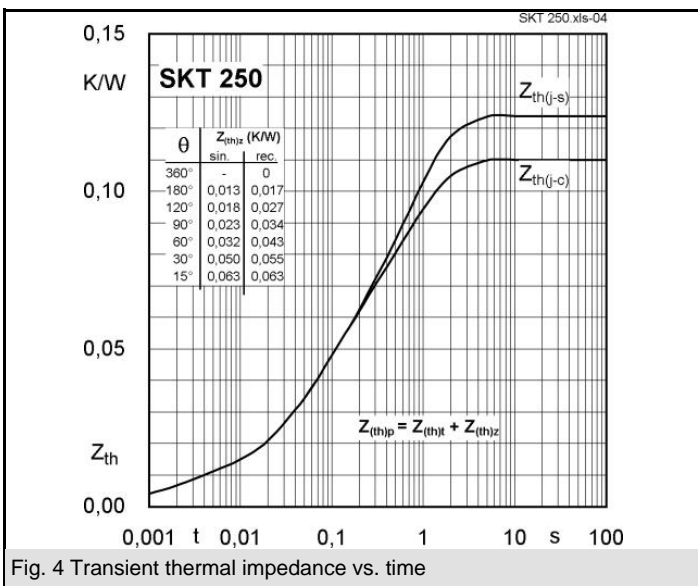
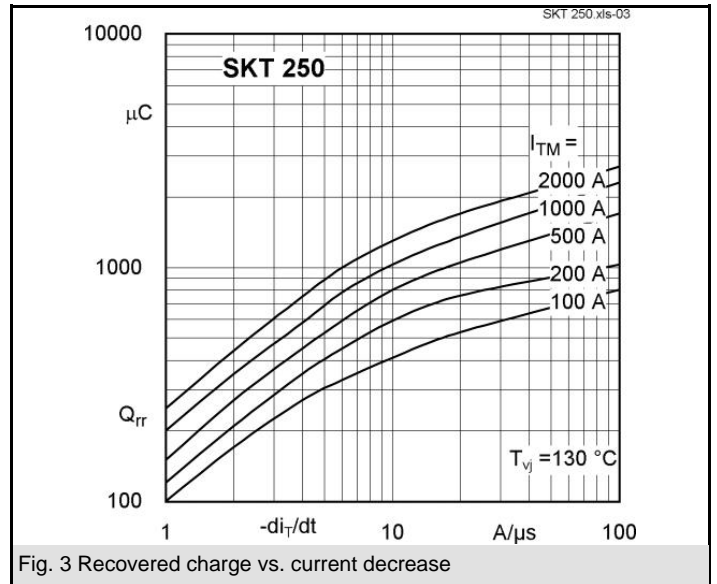
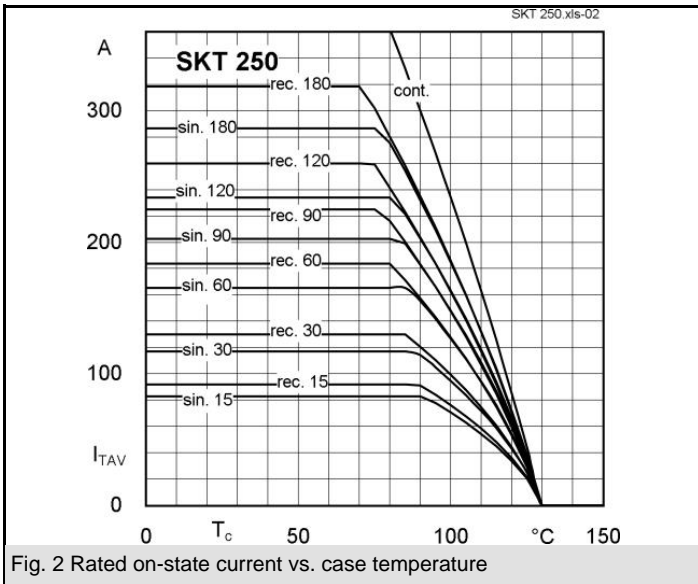
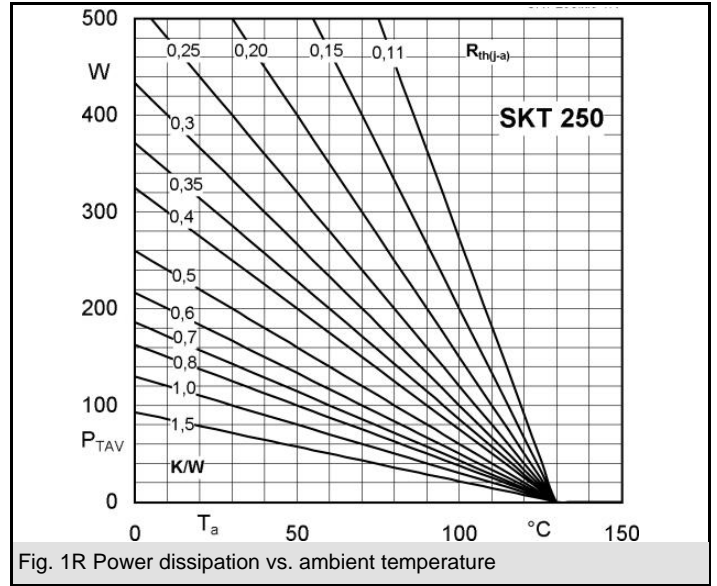
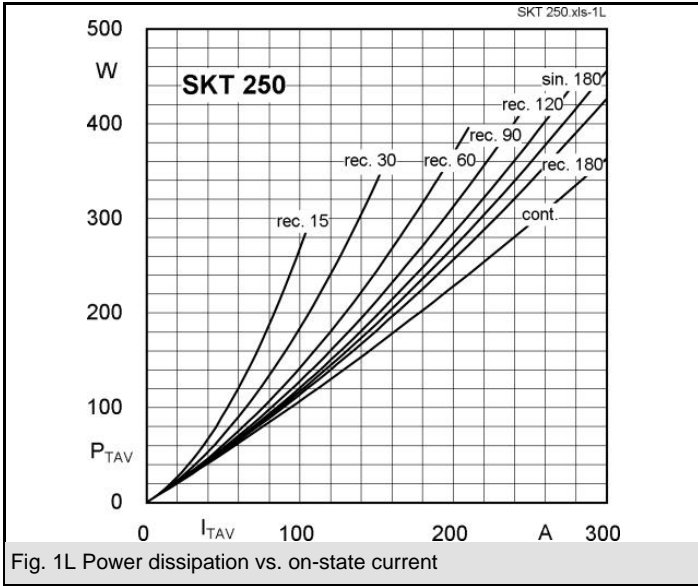

SKT 250

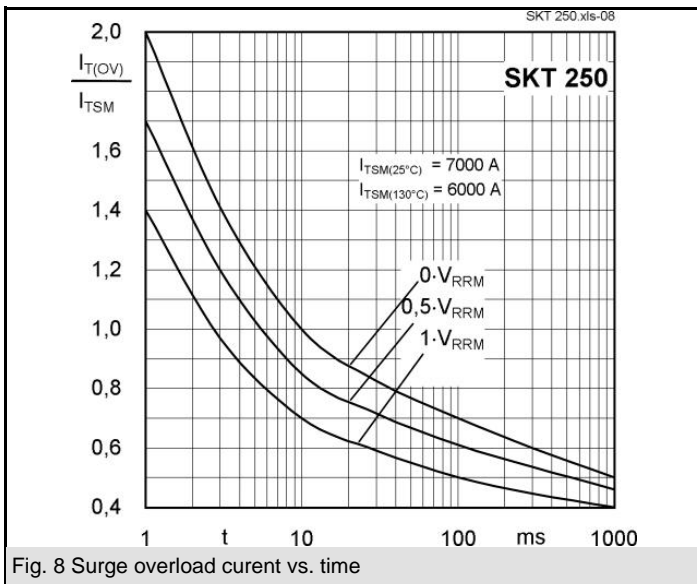
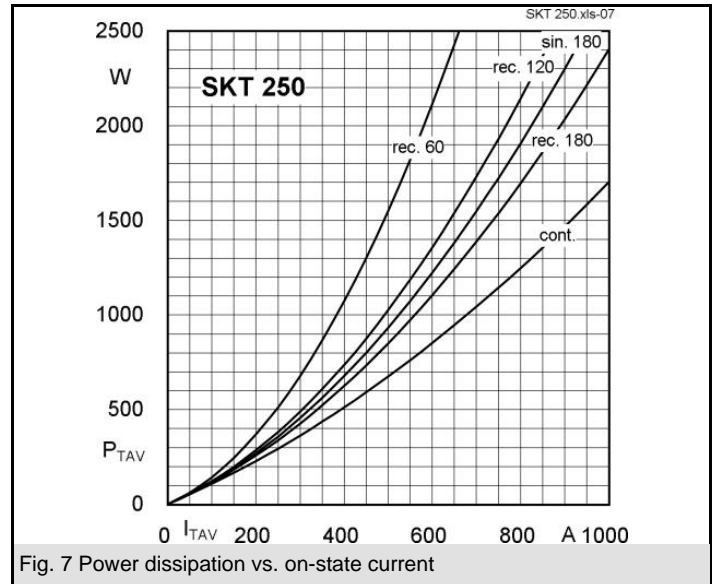
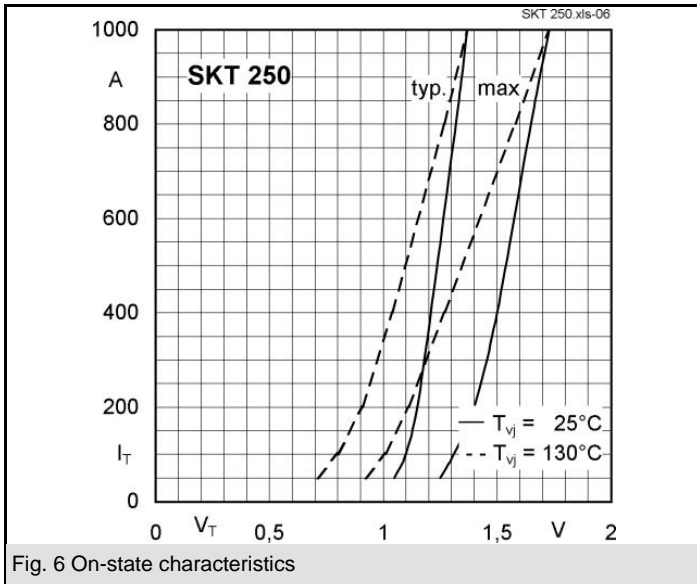

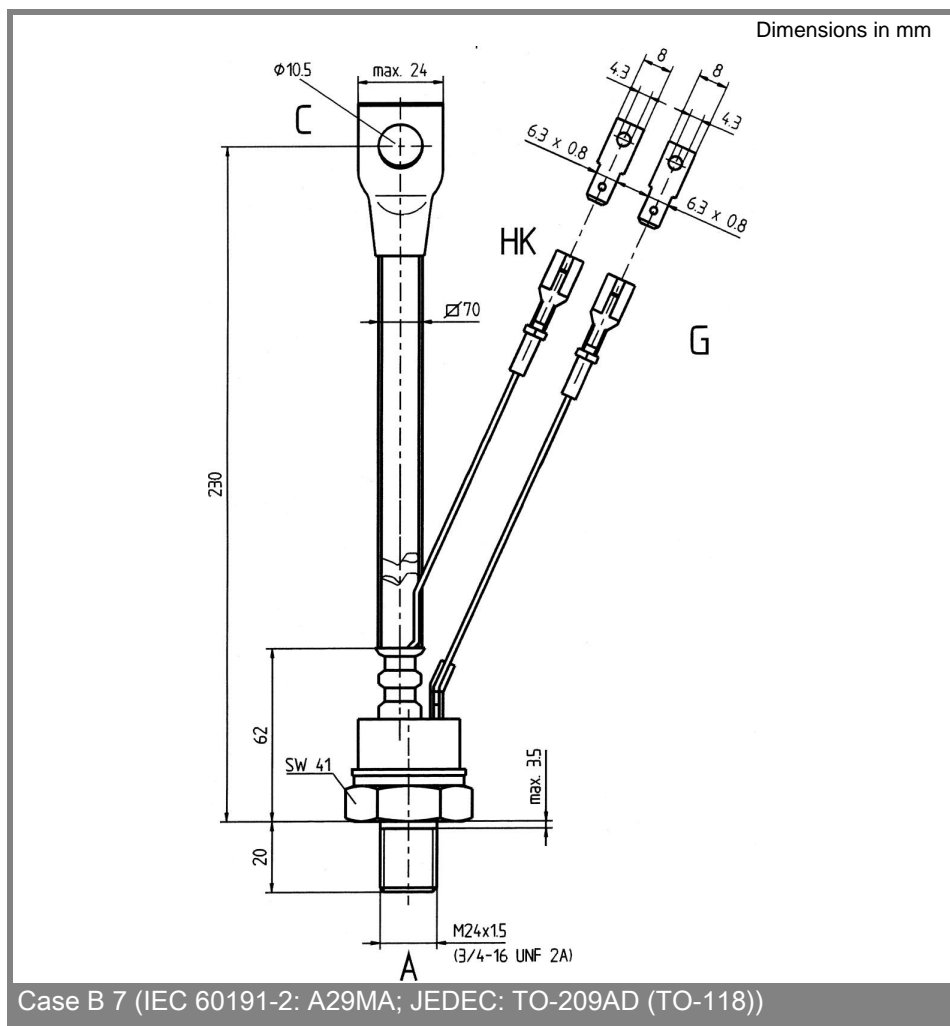
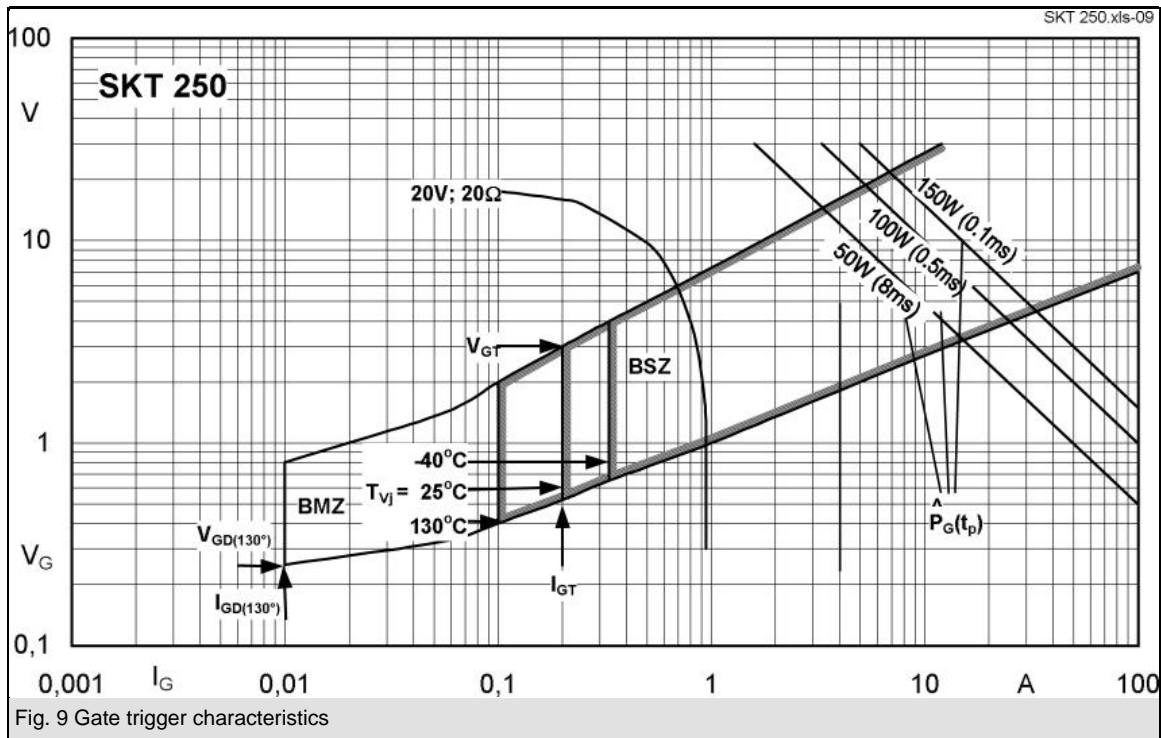

* The specifications of our components may not be considered as an assurance of component characteristics. Components have to be tested for the respective application. Adjustments may be necessary. The use of SEMIKRON

products in life support appliances and systems is subject to prior specification and written approval by SEMIKRON. We therefore strongly recommend prior consultation of our personal.