

**S Series Unsealed, SE Series Sealed, Through-Hole and Surface Mount**

**Product Facts**

- Sealed or Unsealed
- Straight or Right-Angle
- Through-hole or Surface-mount
- Bulk or Tape-and-Reel packaged
- Compact size
- Double-pole function in a single-pole body
- PC retention feature
- High reliability contact system
- Epoxy sealed base
- Robust actuator for easy actuation
- Non-shorting (break-before-make)

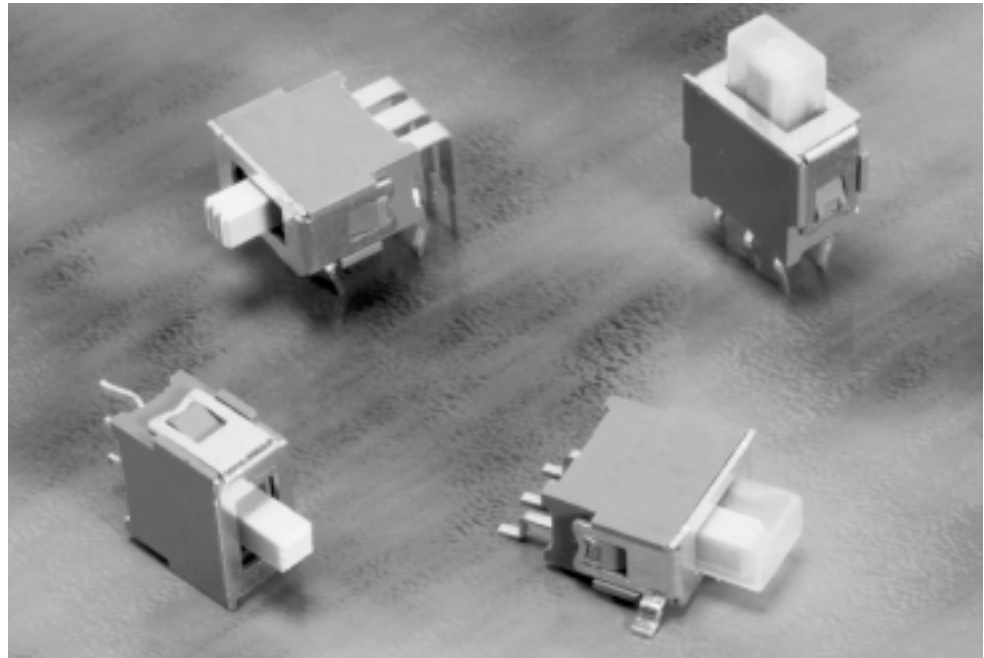

**Switch, Slide, Surface Mount - SE1 SMT (Shown w/Boot)**

**Electrical Characteristics**

**Contact rating:** .4 VA @ 20 VDC Max.  
50mA 48V AC/DC  
Min. 1 micro A 20 mV AC/DC

**Initial Contact Resistance:** less than 50 milliohms

**Final Contact Resistance:** 100 milliohms max.

**Insulation Resistance:** 500 Megaohms @ 250 VDC

**Dielectric Strength:** 500 VAC between terminals and ground

**Mechanical**

**Mechanical Life:** Up to 10,000 cycles @ max. load

**Actuation Force:** 70 to 500 grams

**Materials and Finish**

**Terminals:** Tin-lead over nickel-plated phosphor bronze

**Contacts:** Gold over nickel plated phosphor bronze

**Frame:** Tin over nickel plated brass

**Case, Actuator, Plunger, Terminal Board:** UL 94V-0 glass-filled Polyamide

**Actuator Boot:** Silicon Rubber

**Standards & Specs**

Sealed switch per IP 67

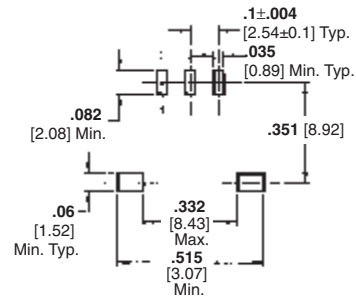
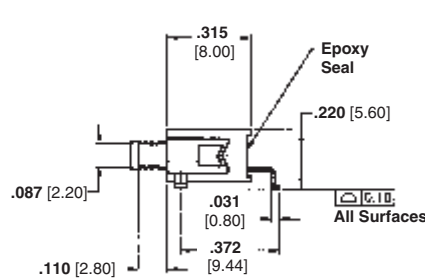
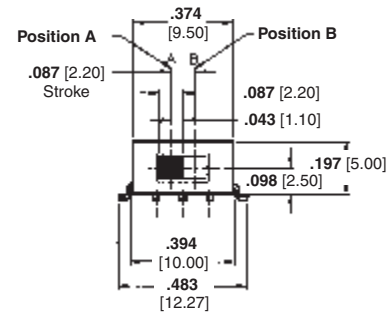
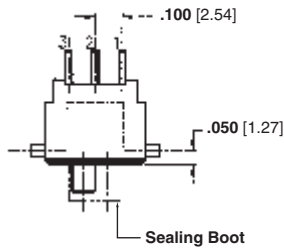

**Recommended P.C.B. Pad Layout**

**SMT-Sealed Part Numbers**

Tyco Electronics	Alcoswitch	Function
1571004-1	SE1GSMT	On-Off
1571004-2	SE1EGSMT	On-Off-On
1571004-3	SE1DGSMT	On-None-On

**Tape & Reel Package**

Tyco Electronics	Alcoswitch	Function
1571004-4	SE1GSMTTR	On-Off
1571004-5	SE1EGSMTTR	On-Off-On
1571004-6	SE1DGSMTTR	On-None-On

**B**  
S/SE Series

**Switch, Slide, PC Tail, S/SE GPC (Shown w/o Boot)**

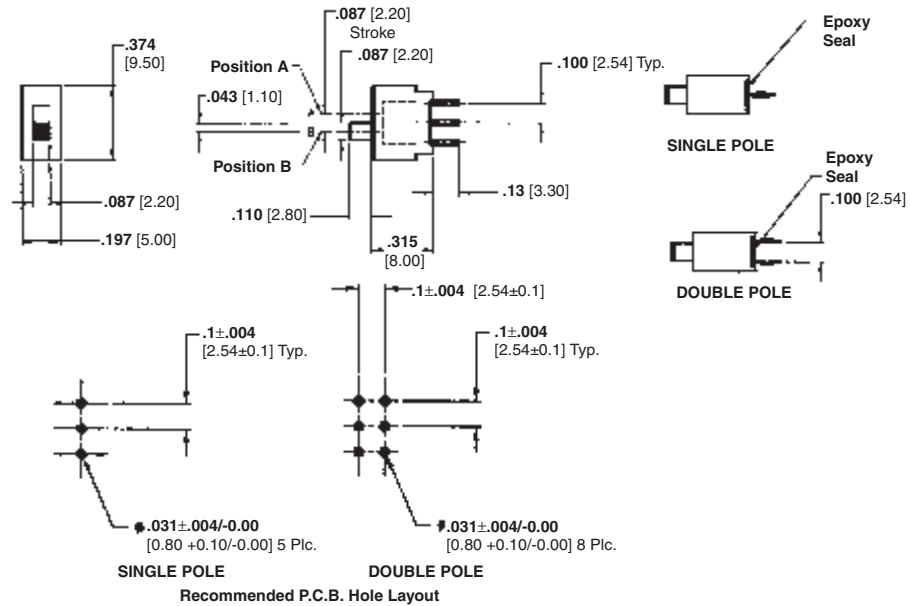

**Sealed Part Numbers w/Boot**

Tyco Electronics	Alcoswitch	Function
1437574-9	SE1DGPC	On-None-On
1-1437574-4	SE1EGPC	On-Off-On
1-1437574-6	SE2DGPC	On-None-On
2-1437574-0	SE2EGPC	On-Off-On

**Unsealed Part Numbers w/o Boot**

Tyco Electronics	Alcoswitch	Function
1571005-1	S1DGPC	On-None-On
1571005-2	S1EGPC	On-Off-On
1571005-3	S2DGPC	On-None-On
1571005-4	S2EGPC	On-Off-On

**Switch, Slide, Right Angle, S/SE GRA (Shown w/o Boot)**

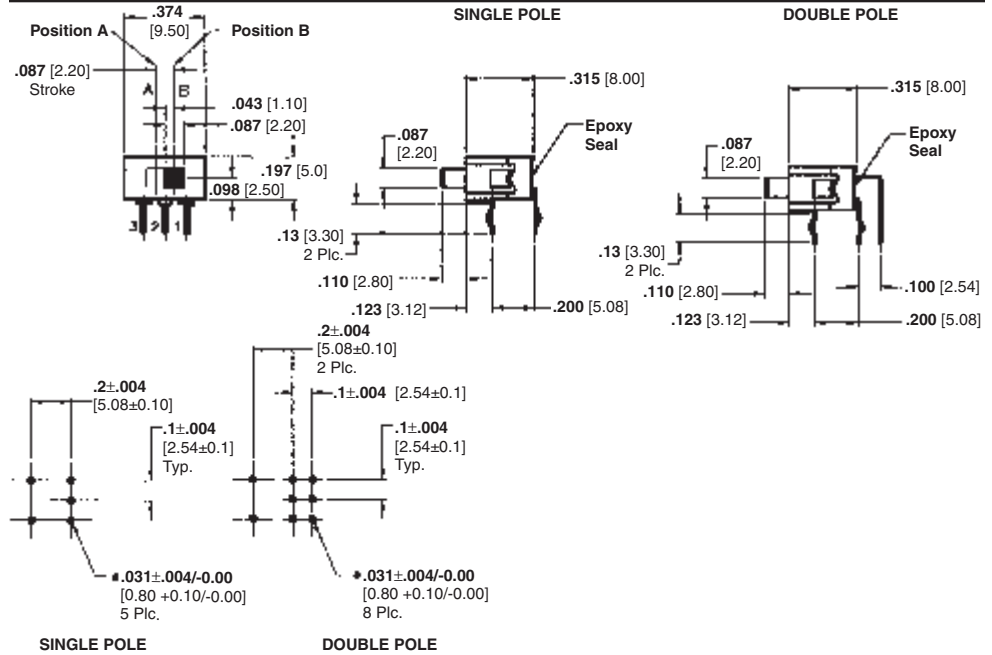

**Sealed Part Numbers w/Boot**

Tyco Electronics	Alcoswitch	Function
1-1437574-1	SE1DGRA	On-None-On
1-1437574-5	SE1EGRA	On-Off-On
1-1437574-8	SE2DGRA	On-None-On
2-1437574-1	SE2EGRA	On-Off-On

**Unsealed Part Numbers w/o Boot**

Tyco Electronics	Alcoswitch	Function
1571006-1	S1DGRA	On-None-On
1571006-2	S1EGRA	On-Off-On
1571006-3	S2DGRA	On-None-On
1571006-4	S2EGRA	On-Off-On

**Slide Switches, Miniature, Low Profile, Economy Grade**

**MATERIAL SPECIFICATIONS:**

Contacts .....Silver clad copper alloy  
 Case Material .....Steel zinc plated  
 Actuator Material .....Polyester (UL 94HB)  
 Terminal Seal .....Epoxy  
 Terminals/Fixed Contacts .....Silver plate copper alloy

**ENVIRONMENTAL SPECIFICATIONS:**

Operating Temperature..... -5°F to 140°F (-15°C to +60°C)  
 Storage Temperature.....-4°F to +158°F (-20°C to +70°C)  
 Solder Heat Resistance .....MIL-STD-202, Method 210

**TYPICAL PERFORMANCE CHARACTERISTICS:**

Contact Rating .....300 mA @ 125 VAC  
 Initial Contact Resistance .....20 Milliohms max.  
 Contact Timing .....Make-before-break  
 Insulation Resistance .....100 Megohms min. @ 500 VDC  
 Dielectric Strength .....500 VAC  
 Actuation Force .....250 Grams, +150 Grams, -100 Grams  
 Actuator Travel.....0.098" (2.49)  
 Life Expectancy .....Up to 10,000 Cycles

**NOTICE: Bifurcated contact produces double wiping, self-cleaning contacts.**

**SPDT**

Part Number			
Tyco Electronics	Alcoswitch	Plating	Mounting Style
5-1437577-8	STS121PC	Silver	Upright

**SPDT**

Part Number			
Tyco Electronics	Alcoswitch	Plating	Mounting Style
5-1437577-9	STS121RA	Silver	Right Angle

**SP3T**

Part Number			
Tyco Electronics	Alcoswitch	Plating	Mounting Style
6-1437577-2	STS131PC	Silver	Upright

**SP3T**

Part Number			
Tyco Electronics	Alcoswitch	Plating	Mounting Style
6-1437577-3	STS131RA	Silver	Right Angle

**Slide Switches, Miniature, Low Profile, Economy Grade**

SEE PAGE B13 FOR PRODUCT SPECIFICATIONS

SP3T



STS1300PC

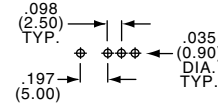
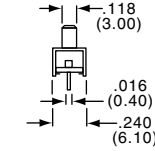
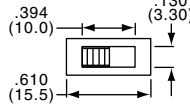
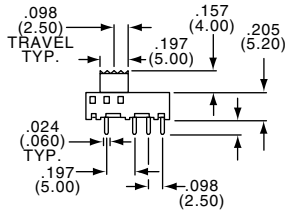

P. C. HOLE LAYOUT

SP3T



STS1300RA

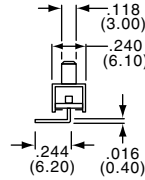
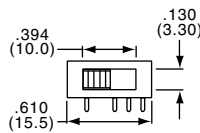

Part Number			
Tyco Electronics	Alcoswitch	Plating	Mounting Style
6-1437577-0	STS1300PC	Silver	Upright
6-1437577-1	STS1300RA	Silver	Right Angle

SP4T



STS1400PC

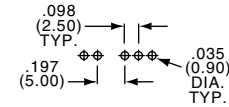
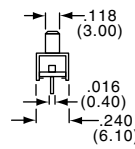
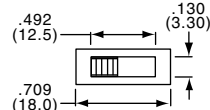
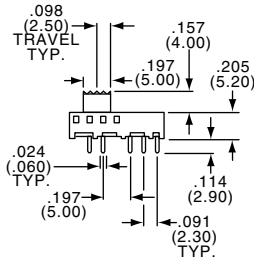

P. C. HOLE LAYOUT

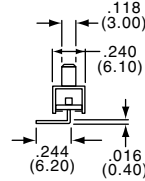
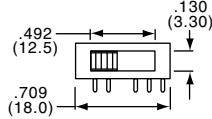

Part Number			
Tyco Electronics	Alcoswitch	Plating	Mounting Style
6-1437577-5	STS1400PC	Silver	Upright
6-1437577-6	STS1400RA	Silver	Right Angle

SP4T



STS141RA

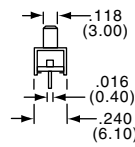
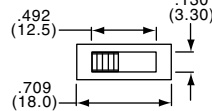
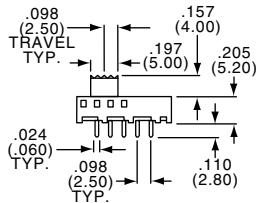

P. C. HOLE LAYOUT

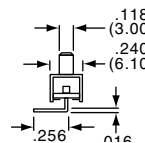
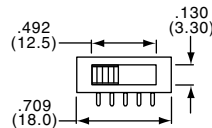

Part Number			
Tyco Electronics	Alcoswitch	Plating	Mounting Style
6-1437577-7	STS141PC	Silver	Upright
6-1437577-8	STS141RA	Silver	Right Angle

**Slide Switches, Miniature, Low Profile, Economy Grade**

SEE PAGE B13 FOR PRODUCT SPECIFICATIONS

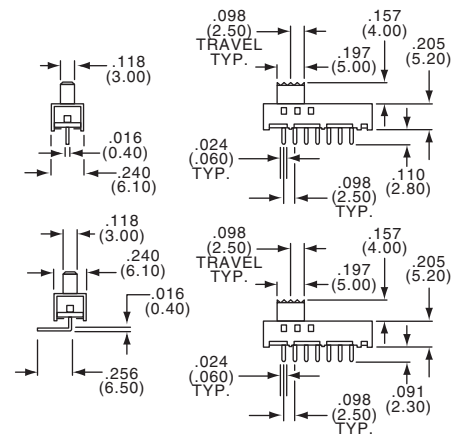
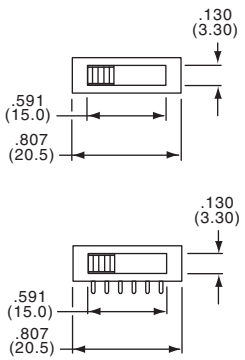
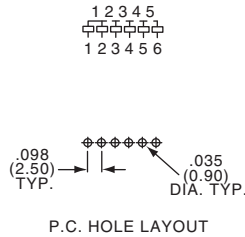

Part Number			
Tyco Electronics	Alcoswitch	Plating	Mounting Style
6-1437577-9	STS151PC	Silver	Upright
7-1437577-0	STS151RA	Silver	Right Angle

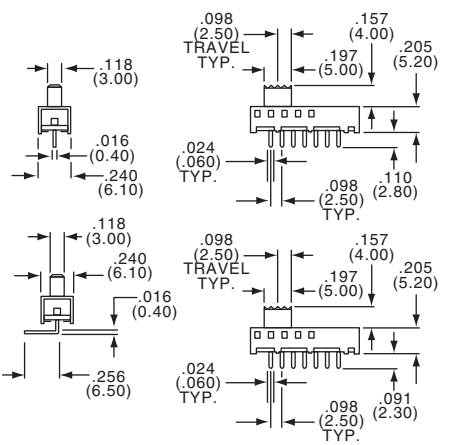
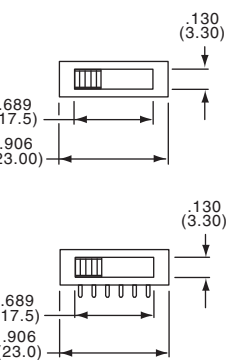
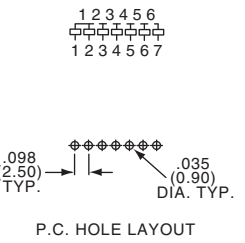

Part Number			
Tyco Electronics	Alcoswitch	Plating	Mounting Style
7-1437577-1	STS161PC	Silver	Upright
7-1437577-2	STS161RA	Silver	Right Angle

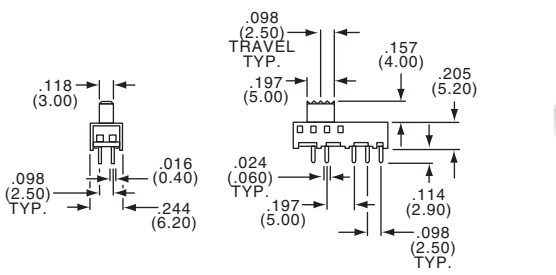
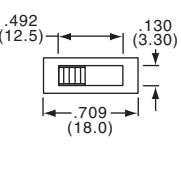
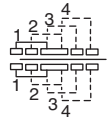
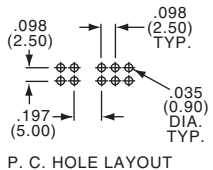
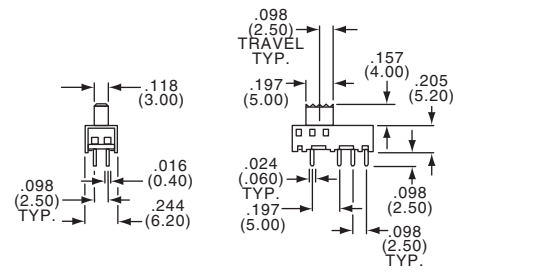
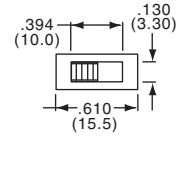
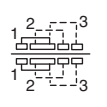
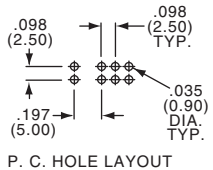

Part Number				
Tyco Electronics	Alcoswitch	Plating	Mounting Style	
7-1437577-4	STS2300PC	DP3T	Silver	Upright
7-1437577-6	STS2400PC	DP4T	Silver	Upright