

# SDP8436

## Silicon Phototransistor

### SWITCHING TIME TEST CIRCUIT

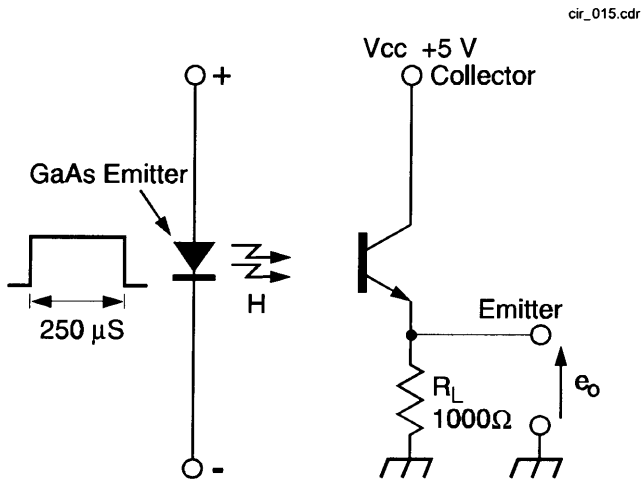

### SWITCHING WAVEFORM

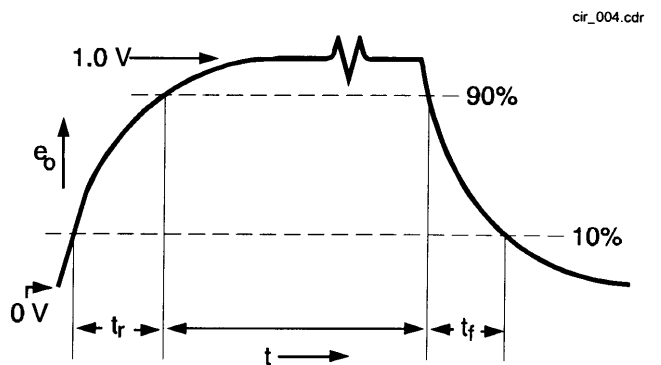

Fig. 1 Responsivity vs Angular Displacement

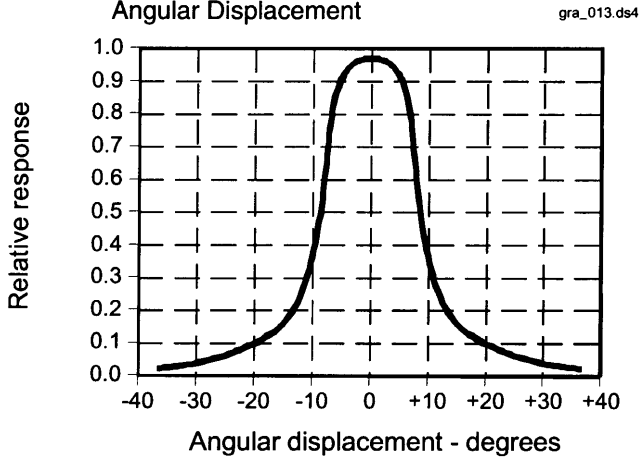

Fig. 2 Collector Current vs Ambient Temperature

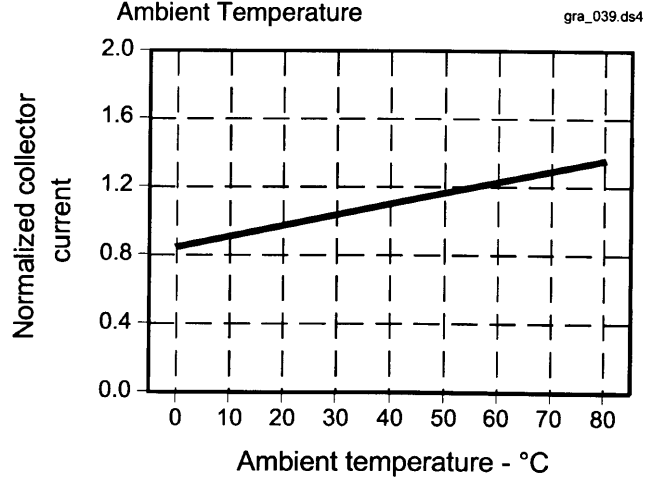

Fig. 3 Dark Current vs Temperature

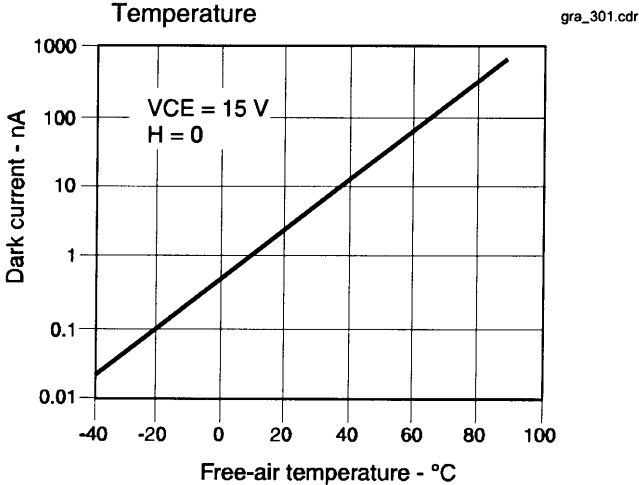
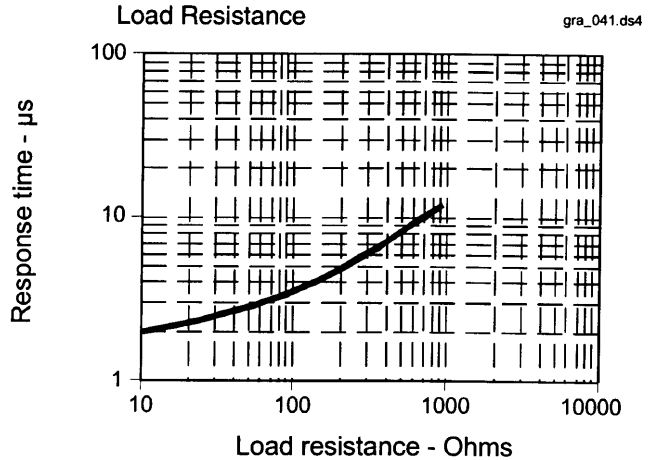

Fig. 4 Non-Saturated Switching Time vs Load Resistance



# SDP8436

## Silicon Phototransistor

Fig. 5 Spectral Responsivity

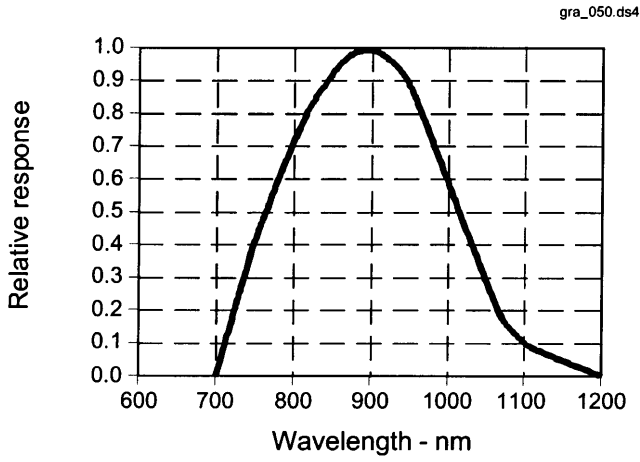
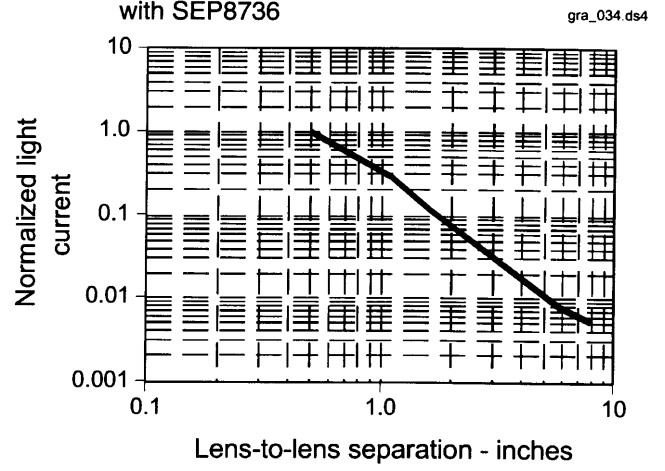

Fig. 6 Coupling Characteristics with SEP8736



All Performance Curves Show Typical Values

# SDP8436 Dimensions.

