

Power management (dual transistors)

EMF32 / UMF32N

DTA143T and 2SK3019 are housed independently in a EMT6 package.

●Application

Power management circuit

●Features

- 1) Power switching circuit in a single package.
- 2) Mounting cost and area can be cut in half.

●Structure

Silicon epitaxial planar transistor

●Equivalent circuits

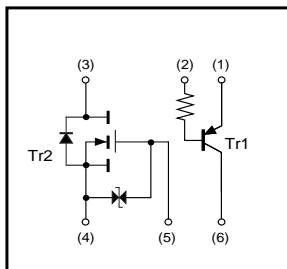

●Packaging specifications

Type	EMF32	UMF32
Package	EMT6	UMT6
Marking	F32	F32
Code	T2R	TR
Basic ordering unit (pieces)	8000	3000

●External dimensions (Unit : mm)

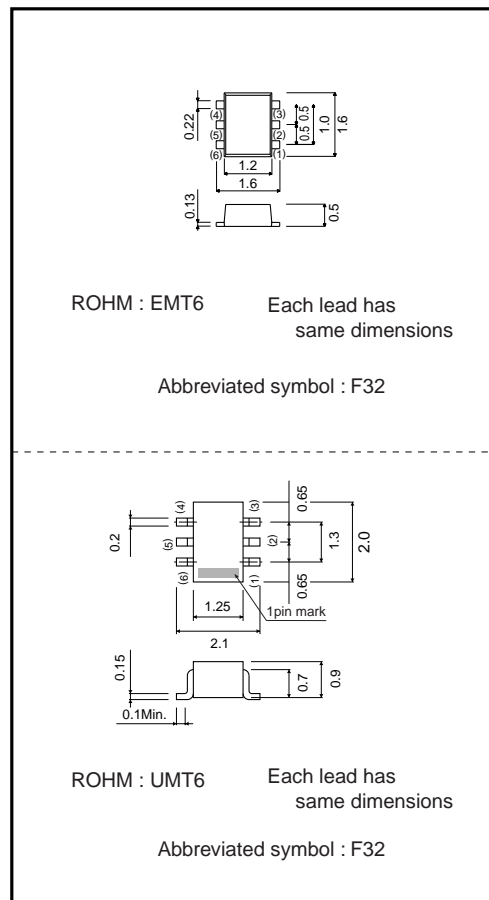

Transistors

●Absolute maximum ratings (Ta=25°C)

Tr1

Parameter	Symbol	Limits	Unit
Collector-base voltage	V _{CB0}	-50	V
Collector-emitter voltage	V _{CEO}	-50	V
Emitter-base voltage	V _{EBO}	-5	V
Collector current	I _c	-100	mA
Power dissipation	P _c	150(TOTAL)	mW *1
Junction temperature	T _j	150	°C
Range of storage temperature	T _{stg}	-55 to +150	°C

*1 120mW per element must not be exceeded. Each terminal mounted on a recommended land.

Tr2

Parameter	Symbol	Limits	Unit
Drain-source voltage	V _{DSS}	30	V
Gate-source voltage	V _{GSS}	±20	V
Drain current	Continuous	I _D	100 mA
	Pulsed	I _{DP}	200 mA *1
Reverse drain current	Continuous	I _{DR}	100 mA
	Pulsed	I _{DRP}	200 mA *1
Total power dissipation	P _D	150(TOTAL)	mW *2
Channel temperature	T _{ch}	150	°C
Range of storage temperature	T _{stg}	-55 to +150	°C

*1 PW≤10ms Duty cycle≤50%

*2 120mW per element must not be exceeded. Each terminal mounted on a recommended land.

●Electrical characteristics (Ta=25°C)

Tr1

Parameter	Symbol	Min.	Typ.	Max.	Unit	Conditions
Collector-base breakdown voltage	BV _{CB0}	-50	-	-	V	I _c =-50μA
Collector-emitter breakdown voltage	BV _{CEO}	-50	-	-	V	I _c =-1mA
Emitter-base breakdown voltage	BV _{EBO}	-5	-	-	V	I _E =-50μA
Collector cutoff current	I _{CB0}	-	-	-0.5	μA	V _{CB} =-50V
Emitter cutoff current	I _{EBO}	-	-	-0.5	μA	V _{EB} =-4V
Collector-emitter saturation voltage	V _{CE(sat)}	-	-	-0.3	V	I _c /I _B =-5mA/-0.25mA
DC current transfer ratio	h _{FE}	100	250	600	-	I _c =-1mA, V _{CE} =-5V
Input resistance	R ₁	3.29	4.7	6.11	kΩ	-
Transition frequency	f _T	-	250	-	MHz	V _{CE} =-10V, I _E =5mA, f=100MHz *

* Transition frequency of the device

Tr2

Parameter	Symbol	Min.	Typ.	Max.	Unit	Conditions
Gate-source leakage	I _{GSS}	-	-	±1	μA	V _{GS} =±20V, V _{DS} =0V
Drain-source breakdown voltage	V _{(BR)DSS}	30	-	-	V	I _D =10μA, V _{GS} =0V
Zero gate voltage drain current	I _{DSS}	-	-	1.0	μA	V _{DS} =30V, V _{GS} =0V
Gate-threshold voltage	V _{GS(th)}	0.8	-	1.5	V	V _{DS} =3V, I _D =100μA
Static drain-source on-state resistance	R _{DS(on)}	-	5	8	Ω	I _D =10mA, V _{GS} =4V
		-	7	13	Ω	I _D =1mA, V _{GS} =2.5V
Forward transfer admittance	Y _{fs}	20	-	-	ms	V _{DS} =3V, I _D =10mA
Input capacitance	C _{iss}	-	13	-	pF	V _{DS} =5V, V _{GS} =0V, f=1MHz
Output capacitance	C _{oss}	-	9	-	pF	
Reverse transfer capacitance	C _{rss}	-	4	-	pF	
Turn-on delay time	t _{d(on)}	-	15	-	ns	
Rise time	t _r	-	35	-	ns	I _D =10mA, V _{DD} ≐5V, V _{GS} =5V, R _L =500Ω, R _{GS} =10Ω
Turn-off delay time	t _{d(off)}	-	80	-	ns	
Fall time	t _f	-	80	-	ns	

Transistors

●Electrical characteristic curves

Tr1

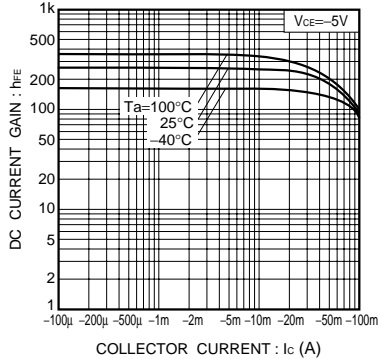

Fig.1 DC current gain vs. collector current

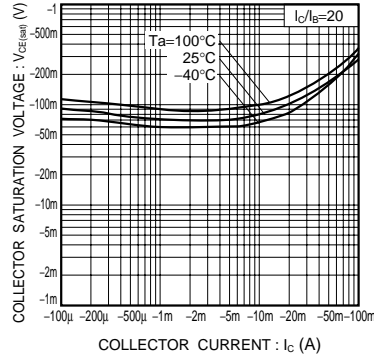

Fig.2 Collector-emitter saturation voltage vs. collector current

Tr2

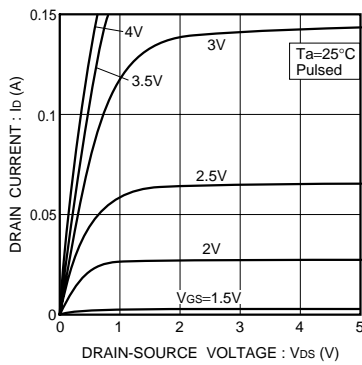

Fig.3 Typical output characteristics

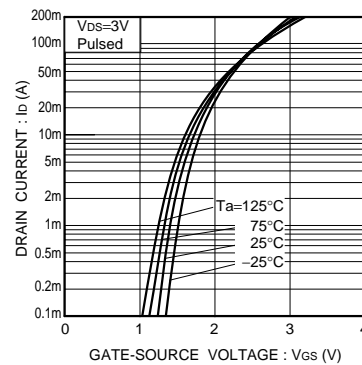

Fig.4 Typical transfer characteristics

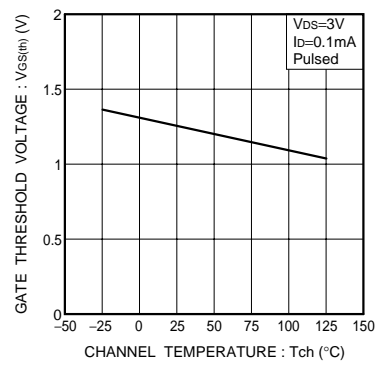

Fig.5 Gate threshold voltage vs. channel temperature

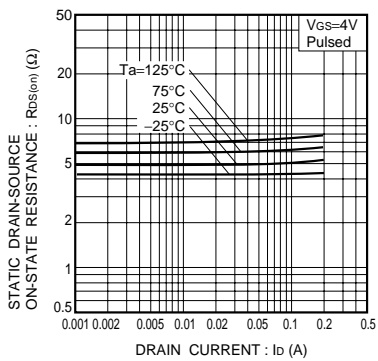

Fig.6 Static drain-source on-state resistance vs. drain current (I)

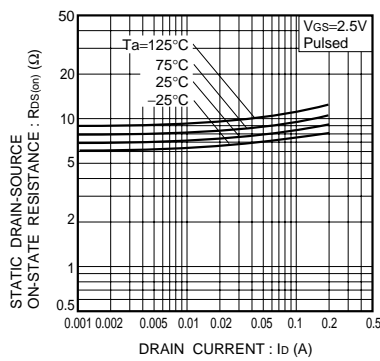

Fig.7 Static drain-source on-state resistance vs. drain current (II)

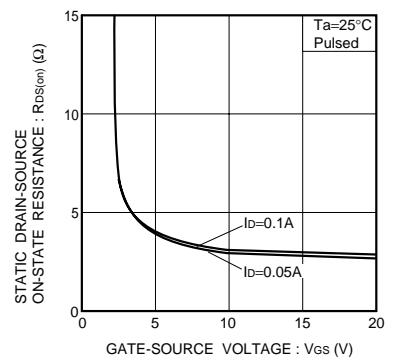

Fig.8 Static drain-source on-state resistance vs. gate-source voltage

Transistors

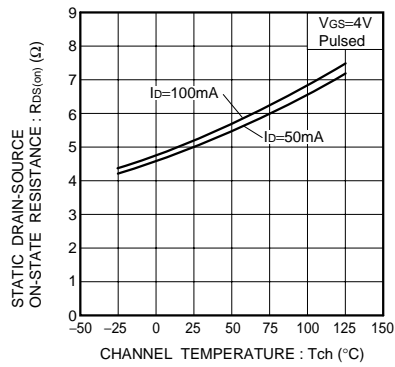

Fig.9 Static drain-source on-state resistance vs. channel temperature

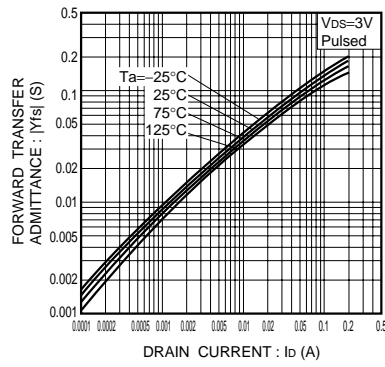

Fig.10 Forward transfer admittance vs. drain current

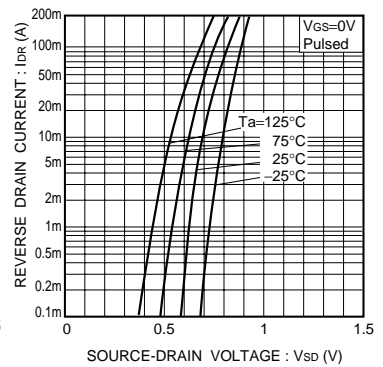

Fig.11 Reverse drain current vs. source-drain voltage (I)

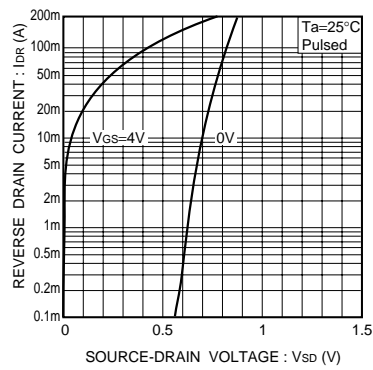

Fig.12 Reverse drain current vs. source-drain voltage (II)

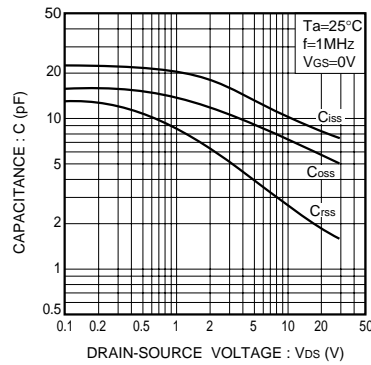

Fig.13 Typical capacitance vs. drain-source voltage

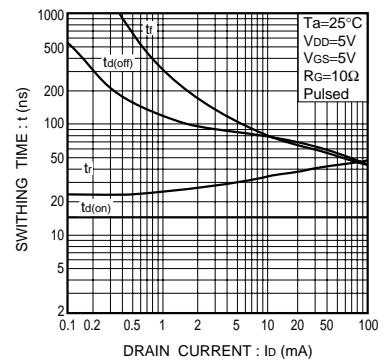

Fig.14 Switching characteristics

Notes

- No technical content pages of this document may be reproduced in any form or transmitted by any means without prior permission of ROHM CO.,LTD.
- The contents described herein are subject to change without notice. The specifications for the product described in this document are for reference only. Upon actual use, therefore, please request that specifications to be separately delivered.
- Application circuit diagrams and circuit constants contained herein are shown as examples of standard use and operation. Please pay careful attention to the peripheral conditions when designing circuits and deciding upon circuit constants in the set.
- Any data, including, but not limited to application circuit diagrams information, described herein are intended only as illustrations of such devices and not as the specifications for such devices. ROHM CO.,LTD. disclaims any warranty that any use of such devices shall be free from infringement of any third party's intellectual property rights or other proprietary rights, and further, assumes no liability of whatsoever nature in the event of any such infringement, or arising from or connected with or related to the use of such devices.
- Upon the sale of any such devices, other than for buyer's right to use such devices itself, resell or otherwise dispose of the same, no express or implied right or license to practice or commercially exploit any intellectual property rights or other proprietary rights owned or controlled by
- ROHM CO., LTD. is granted to any such buyer.
- Products listed in this document are no antiradiation design.

The products listed in this document are designed to be used with ordinary electronic equipment or devices (such as audio visual equipment, office-automation equipment, communications devices, electrical appliances and electronic toys).

Should you intend to use these products with equipment or devices which require an extremely high level of reliability and the malfunction of which would directly endanger human life (such as medical instruments, transportation equipment, aerospace machinery, nuclear-reactor controllers, fuel controllers and other safety devices), please be sure to consult with our sales representative in advance.

About Export Control Order in Japan

Products described herein are the objects of controlled goods in Annex 1 (Item 16) of Export Trade Control Order in Japan.

In case of export from Japan, please confirm if it applies to "objective" criteria or an "informed" (by MITI clause) on the basis of "catch all controls for Non-Proliferation of Weapons of Mass Destruction.