

# .100" × .600" DIP

40 Position



- Fits standard IC sockets
- Strong legs, less susceptible to bending or breaking
- Gold or tin lead plating options
- Round or rectangular contact leg options
- Low profile

Date Modified: February 19, 1999

TS-0618-05  
Sheet 1 of 2

132

---

## Physical

### Insulation

Material: Glass Filled Polyester (PBT)

Flammability: UL94V-0

Color: Gray

### Contact

Material: Copper Alloy

Plating

Underplate: 100  $\mu$ " [ 2.54  $\mu$ m ] Nickel — QQ-N-290, Class 2

U-Slot & Solder Tails: 30  $\mu$ " [ 0.76  $\mu$ m ] Gold — MIL-G-45204, Type II, Grade C or  
200  $\mu$ " [ 0.76  $\mu$ m ] 90/10 Tin Lead — MIL-P-81728

**Wire Accomodation:** 26 & 28 AWG Solid or Stranded

**Marking:** 3M Logo, Part Identification and Contact Position Numbers

---

## Electrical

**Current Rating:** 1 A

**Insulation Resistance:**  $> 1 \times 10^9 \Omega$  at 500 VDC

**Withstanding Voltage:** 1000 Vrms at Sea Level

---

## Environmental

**Temperature Rating:**  $-55^\circ\text{C}$  to  $+105^\circ\text{C}$

UL File No.: E68080

---

### 3M Interconnect Solutions Division

6801 River Place Blvd.  
Austin, TX 78726-9000

For technical, sales or ordering information call  
**800-225-5373**

**.100" × .600" DIP**  
**40 Position**

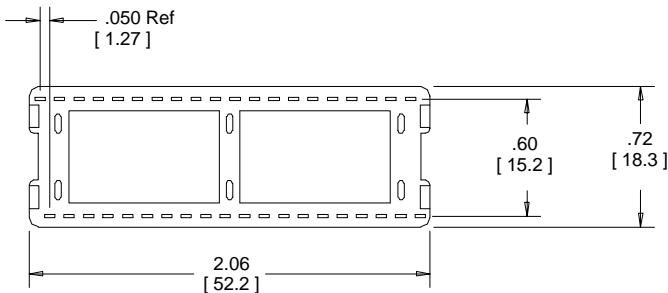
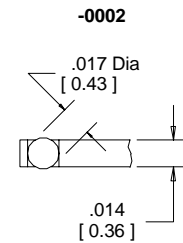
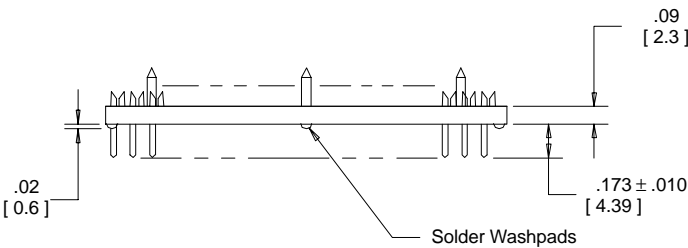
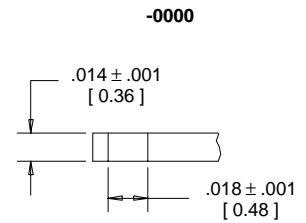
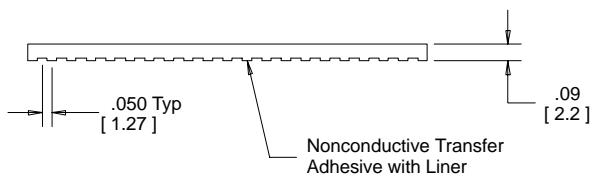
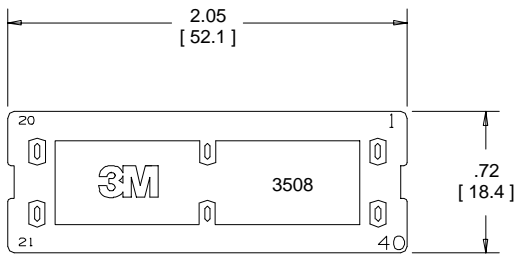
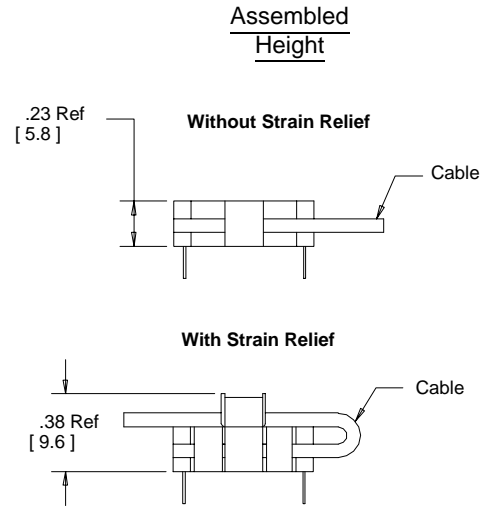
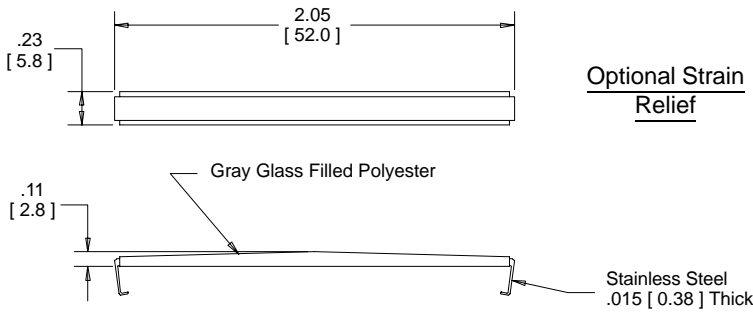

**Inch**  
[mm]

Tolerance Unless Noted			
	.0	.00	.000
Inch	± .1	± .01	± .005

[ ] Dimensions for Reference only

**Ordering Information Connector**

3M Part Number	Contact Type	Contact Plating
3508-0000	Rect	Gold
3508-0000T	Rect	Tin Lead
3508-0002	Round	Gold

**Strain Relief**  
**3448-18**  
**(Order Separately)**

TS-0618-05  
 Sheet 2 of 2

**3M Interconnect Solutions Division**

6801 River Place Blvd.  
 Austin, TX 78726-9000

For technical, sales or ordering information call  
**800-225-5373**