

**Reusable, Vibration-Resistant**

# **SELF-SEALING FASTENERS**



**APM HEXSEAL**

# When simply fastening isn't enough.



## Performance Under Pressure

APM Hexseal's patented pre-assembled self-sealing fasteners are designed to provide both fastening and sealing integrity in a single unit. Their design features a resilient O-ring held captive in a precision engineered groove under the fastener head. This combination of precise groove geometry and O-ring characteristics results in an absolute seal regardless of surface finish, while still providing full metal-to-metal contact.

Vibration-resistant and re-usable, SEELSKREWS®, SEELBOLTS®, and SEELNUTS® can withstand internal/external pressures up to 6,000 psi at temperatures from -160°F to +500°F.

Made in the U.S.A., APM Hexseal self-sealing fasteners are available in standard and metric thread sizes. And the integral seal can be formulated for compatibility with a wide range of gases and liquids.

They represent a superior sealing alternative to sealing compounds, tape, chemical coatings, and deformable washers that attempt to seal the threadform.

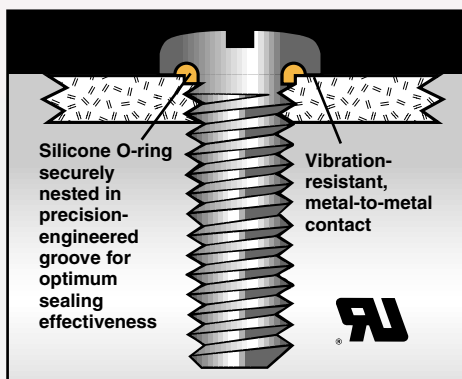

## Features and Benefits

- Positive sealing under pressure or vacuum.
- Easy-to-install ... pre-assembled unit installs like a conventional fastener.
- Metal-to-metal contact resists loosening due to vibration, and assures fastening integrity.
- Re-usable ... repeated installation and removal does not affect sealing effectiveness.
- Compatible with all surface finishes.
- UL and CSA Recognized ... tested and listed to UL Standard 50, Types 1-13, and CSA Standard C22.2 No. 40.
- Optional seal materials assure performance with wide variety of gases and liquids.
- Uniformity and high strength assure repeatable performance.

## Typical Applications

- Fuel Tanks
- Pressure Gauges
- Gear Boxes/Transmissions
- Valves
- Motor Housings
- Cylinders
- Pumps
- Equipment Housings/Cabinets
- Air Conditioning Equipment
- Hydraulic Systems
- Portable Instruments
- Engines
- Aircraft Systems
- Instrument Housings/Panels
- Missiles
- Military Equipment
- Portable Communications Equipment
- Food Processing Systems
- Or any application where leakage can compromise reliability

# SEELSKREW® High-pressure, self-sealing screws

SEELSKREWS® are designed to seal out air, water, lubricants and other liquid or gaseous contaminants. SEELSKREWS® are available in many standard thread sizes and with optional sealing materials. They can also be supplied with NYLOK®, a black oxide, painted heads, or in a captivated (KAPTO-SKREW®) configuration. Sheet metal and other type fasteners available on special order.

## STANDARD PAN HEAD (available from stock)

THREAD SIZE	LENGTHS*	C MAX.	D MAX.	Recom. Clear. Hole‡	
				MIN.	MAX.
2-56UNC-2A	1/4" to 5/8" incl.	.168"	.055"	.091"	.095"
3-56UNF-2A	1/4" to 5/8" incl.	.194"	.063"	.109"	.113"
3-48UNC-2A	1/4" to 5/8" incl.	.194"	.063"	.109"	.113"
4-40UNC-2A	1/4" to 1" incl.	.220"	.069"	.125"	.129"
5-40UNC-2A	1/4" to 1" incl.	.245"	.075"	.140"	.144"
6-32UNC-2A	1/4" to 1" incl.	.271"	.083"	.147"	.152"
8-32UNC-2A	1/4" to 1" incl.	.323"	.097"	.173"	.179"
10-32UNF-2A	1/4" to 1" incl.	.374"	.113"	.199"	.204"
10-24UNC-2A	1/4" to 1" incl.	.374"	.113"	.199"	.204"
1/4-20UNC-2A	5/16" to 1 1/4" incl.	.493"	.148"	.265"	.269"

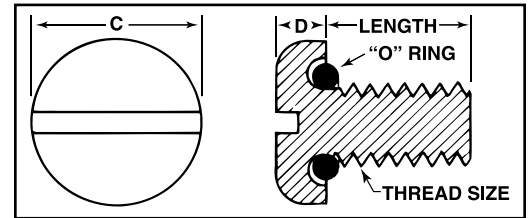

TYPE S SLOTTED

## OVERSIZED PAN HEAD (on special order only)

THREAD SIZE	LENGTHS in increments of 1/8"	C MAX.	D MAX.	Recom. Clear. Hole‡	
				MIN.	MAX.
4-40UNC-2A	1/4" to 1" incl.	.245"	.075"	.144"	.148"
6-32UNC-2A	1/4" to 1" incl.	.296"	.089"	.171"	.175"
8-32UNC-2A	1/4" to 1" incl.	.373"	.112"	.201"	.205"
10-32UNF-2A	1/4" to 1" incl.	.425"	.125"	.257"	.261"
10-24UNC-2A	1/4" to 1" incl.	.425"	.125"	.257"	.261"

Oversized Head SEELSKREWS® are only for those applications where extra large clearance holes are required.

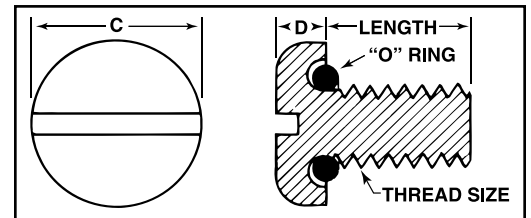

TYPE SL OVERSIZED SLOTTED

## METRIC PAN HEAD (available from stock)

THREAD SIZE	LENGTHS	C MAX.		D MAX.		Recom. Clear. Hole‡				
		inch	mm	inch	mm	inch	mm	inch	mm	
M2	mm	4, 8, 12	.167	4.24	.054	1.37	.091	2.31	.095	2.41
	inch	.157, .315, .472								
M3	mm	6, 12, 20	.245	6.22	.075	1.90	.140	3.55	.144	3.65
	inch	.236, .472, .787								
M4	mm	6, 12, 20	.322	8.17	.096	2.43	.173	4.39	.179	4.54
	inch	.236, .472, .787								
M6	mm	12, 20, 25	.492	12.49	.147	3.73	.265	6.73	.269	6.83
	inch	.472, .787, .984								

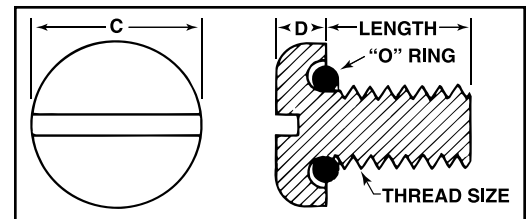

TYPE SM METRIC SLOTTED

## STANDARD PAN HEAD (available from stock) TYPE R PHILLIPS RECESSED

THREAD SIZE	LENGTHS*	C MAX.	D MAX.	Recom. Clear. Hole‡	
				MIN.	MAX.
2-56UNC-2A	1/4" to 1" incl.	.181"	.062"	.091"	.095"
4-40UNC-2A	1/4" to 1" incl.	.238"	.080"	.125"	.129"
6-32UNC-2A	1/4" to 1" incl.	.294"	.097"	.147"	.152"
8-32UNC-2A	1/4" to 1" incl.	.347"	.115"	.173"	.179"
10-32UNF-2A	3/8" to 1" incl.	.403"	.133"	.199"	.204"
10-24UNC-2A	3/8" to 1" incl.	.403"	.133"	.199"	.204"
1/4-20UNC-2A	3/8" to 1 1/4" incl.	.517"	.175"	.265"	.269"

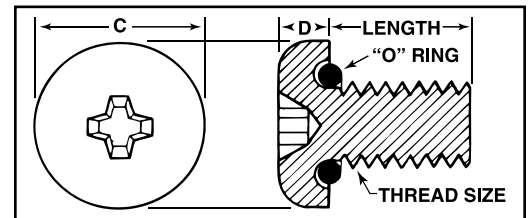

TYPE R PHILLIPS RECESSED (MEETS REQUIREMENTS OF MS 3212 & MS 3213)

## METRIC PAN HEAD (on special order only) TYPE RM PHILLIPS RECESSED

THREAD SIZE	LENGTHS	C MAX.		D MAX.		Recom. Clear. Hole‡				
		inch	mm	inch	mm	inch	mm	inch	mm	
M2	mm	4, 8, 12	.167	4.24	.062	1.57	.091	2.31	.095	2.41
	inch	.157, .315, .472								
M3	mm	6, 12, 20	.263	6.68	.089	2.26	.140	3.55	.144	3.65
	inch	.236, .472, .787								
M4	mm	6, 12, 20	.322	8.17	.115	2.92	.173	4.39	.179	4.54
	inch	.236, .472, .787								
M6	mm	12, 20, 25	.492	12.49	.175	4.44	.265	6.73	.269	6.83
	inch	.472, .787, .984								

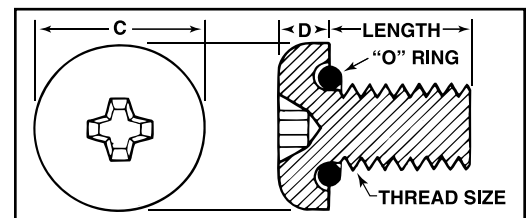

TYPE RM PHILLIPS RECESSED

## FLAT HEAD (available from stock)

THREAD SIZE	LENGTHS*	C MAX.	Recom. Clear. Hole‡	
			MIN.	MAX.
2-56UNC-2A**	1/4" to 1" incl.	.172"	.091"	.095"
4-40UNC-2A	1/4" to 1" incl.	.225"	.125"	.129"
6-32UNC-2A	1/4" to 1" incl.	.279"	.147"	.152"
8-32UNC-2A	1/4" to 1" incl.	.332"	.173"	.179"
10-24UNF-2A	5/16" to 1" incl.	.385"	.199"	.204"
10-32UNC-2A	5/16" to 1" incl.	.385"	.199"	.204"
1/4-20UNC-2A	3/8" to 1 1/4" incl.	.507"	.265"	.269"

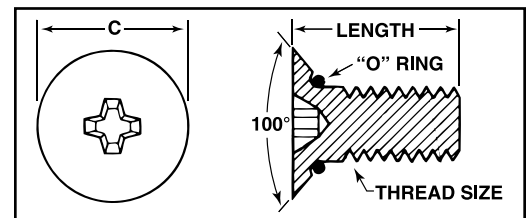

TYPE SFR PHILLIPS RECESSED

\*In increments of 1/16" up to 5/8" long; from 5/8" long and up, in increments of 1/8". Tolerance up to 1" length + 0 - 1/32; 1" to 2" + 0 - 1/16. \*\*82° countersink.

‡To assure maximum sealing performance of SEELSKREWS® a clearance hole must be used.

# SEELBOLTS® High-pressure, self-sealing bolts

SEELBOLTS® are designed to seal out air, water, lubricants and other liquids or gaseous contaminants. SEELBOLTS® are available in many standard thread sizes and with optional sealing materials. They can also be supplied with NYLOK®, a black oxide, painted heads, or in a captivated (KAPTO-SKREW®) configuration.

## TYPE ST HEXAGON HEAD SEELBOLTS

THREAD SIZE	P NOM.	H MAX.	Flats MAX.	Clear. Hole±		LENGTHS Up to 1" + 0 - 1/32 1" to 2" + 0 - 1/16
				Min.	Max.	
1/4-28UNF-2A	.510"	.163"	.440"	.265"	.269"	3/8", 1/2", 5/8", 3/4"
1/4-20UNC-2A	.510"	.163"	.440"	.265"	.269"	3/8", 1/2", 5/8", 3/4"
5/16-24UNF-2A	.580"	.211"	.502"	.332"	.336"	1/2", 5/8", 3/4", 7/8"
5/16-18UNC-2A	.580"	.211"	.502"	.332"	.336"	3/8", 1/2", 5/8", 3/4", 7/8"
3/8-24UNF-2A	.650"	.243"	.565"	.395"	.399"	5/8", 3/4", 7/8", 1"
3/8-16UNC-2A	.650"	.243"	.565"	.395"	.399"	1/2", 5/8", 3/4", 7/8", 1"
1/2-20UNF-2A	.870"	.323"	.752"	.530"	.534"	1 1/8", 1 1/4"
1/2-13UNC-2A	.870"	.323"	.752"	.530"	.534"	3/4", 7/8", 1", 1 1/8", 1 1/4"

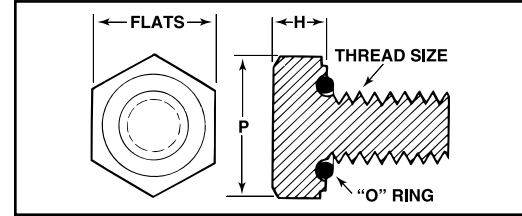

TYPE ST HEXAGON HEAD SEELBOLTS

## TYPE SB & AN SEELBOLTS

THREAD SIZE	AN Equiv.	P NOM.	H MAX.	Flats MAX.	Clear. Hole±		LENGTHS +1/32 - 1/16
					Min.	Max.	
1/4-28UNF-3A	AN4C	.510"	.172"	.440"	.265"	.269"	15/32", 17/32", 21/32", 25/32", 29/32", 1 1/32", 1 5/32", 1 9/32"
5/16-24UNF-3A	AN5C	.580"	.204"	.502"	.332"	.336"	19/32", 23/32", 27/32", 31/32", 1 3/32", 1 7/32", 1 11/32", 1 15/32", 1 19/32"
3/8-24UNF-3A	AN6C	.650"	.235"	.565"	.395"	.399"	45/64", 53/64", 61/64", 1 1/64", 1 3/64", 1 29/64"

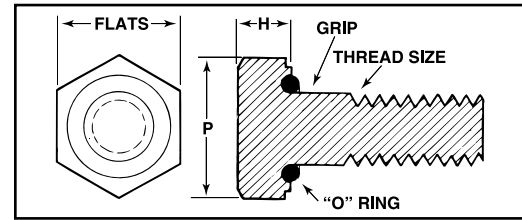

TYPE SB AN TYPE SEELBOLTS

## SEELSKREW®, SEELBOLT® & SEELNUT® SPECIFICATIONS

**Material:** SEELSKREWS® and SEELBOLTS® — Non-magnetic stainless steel (passivated), SEELNUTS® — Brass (nickel-plated) or steel (zinc-plated). Other materials available on request. Silicone rubber per ZZ-R-765, Class I & II, Grade 70. Other seal materials available. Note: Type SB SEELBOLTS® meet requirements of MIL-B-6812, material is stainless steel (magnetic).

**Threads:** Class 2 threads (normal commercial tolerance) are standard on stock SEELSKREWS®, SEELBOLTS® and SEELNUTS®. Class 1 (loose tolerance) and Class 3 (tight tolerance) threads are available on special order.

**Temperature Range:** -160°F to +500°F (-106°C to +260°C).

**Pressure Range:** Up to 6000 psi, internal and external, subject to clearance hole dimensions. Check factory for test data.

**Shelf Life:** Excess of 25 years.

**Resistant to:** Salt water, weather, dirt, dust, sunlight, ozone and most acids. See Table I.

**Agency Listings:** UL and CSA.

**Installation:** Install in same manner as standard fasteners. Standard break-edge practices for deburring (i.e. break-sharp edges of 0.005" maximum) are permissible. Recommended clearance hole depth is 2 to 3 times thread pitch. See detail below.

**Minimum Thread Length:** SEELSKREWS®: For machine screws up to 1 1/4" long, the complete thread should extend to within two threads (or closer) of the bearing surface of the head.

SEELBOLTS®: For bolts up to 1 1/4" long, the minimum thread length should be twice the diameter plus 1/4" (with a tolerance of plus 2 1/2 threads or 3/16", whichever is greater). For bolts too short for this minimum, the distance from the bearing surface of the head to the first complete thread shall not exceed the length of 2 1/2 threads as measured with a ring thread gauge.

## TYPICAL CLEARANCE HOLE DETAIL

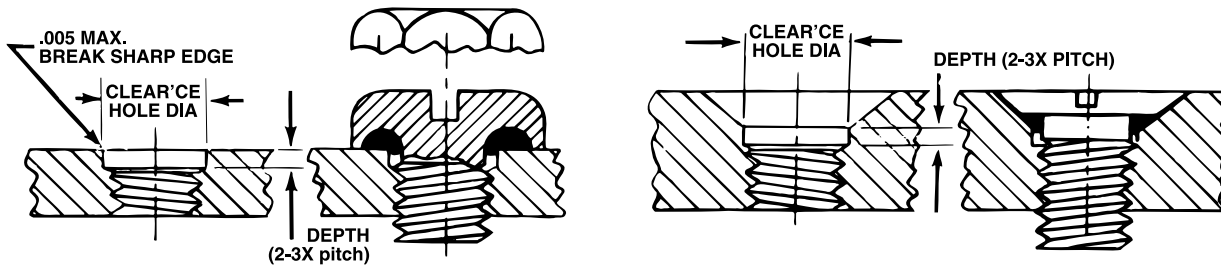

To assure maximum sealing performance of SEELSKREWS® and SEELBOLTS® a clearance hole must be used.

## HOW TO ORDER

**SEELSKREWS®:** When ordering specify head style, thread size and length.

Examples:

- To order a slotted head SEELSKREW with an 8-32 thread, 1/2" long, specify: SEELSKREW S8-32 x 1/2"
- To order an oversized slotted head SEELSKREW with a 4-40 thread, 3/4" long, specify: SEELSKREW SL 4-40 x 3/4"
- To order a Phillips head SEELSKREW with an M4 metric thread, 12 mm long, specify: SEELSKREW RM 4 x 12mm

**SEELBOLTS®:** When ordering specify head style, thread size and length.

Examples:

- To order a Type ST SEELBOLT with a 1/2-20UNF thread, 1" long, specify: SEELBOLT ST 1/2-20UNF x 1"

**SEELNUTS®:** When ordering specify thread size. Example:

- To order a SEELNUT with an 8-32 thread, specify: SEELNUT 8-32

For non-stock thread sizes/head styles/lengths, or other sealing materials, please consult the factory. KAPTO-SKREWS® and NYLOK® are available on special order.

NYLOK® is a trademark of NYLOK FASTENER CORPORATION.

# SEELNUTS® High-pressure, self-sealing locking nuts

SEELNUTS® are designed for use on all types of adjusting screws, threaded studs, and machine bolts in applications where leakage may occur due to extreme pressures. Installed like an ordinary nut, SEELNUTS® form a high-pressure seal along the thread section and contact surface when torqued. Their single-piece design eliminates the need for gaskets, sealing compounds and surface preparations. Fully-adjustable and reusable, they resist vibration, provide metal-to-metal contact, and seal under vacuum or high pressure. Available in all standard thread sizes, the integral seal can be formulated for compatibility with most gases or liquids.

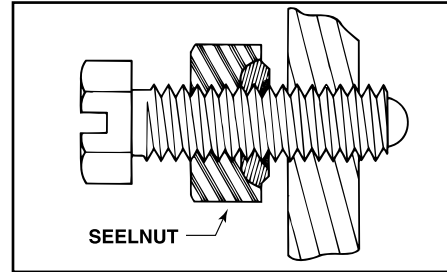
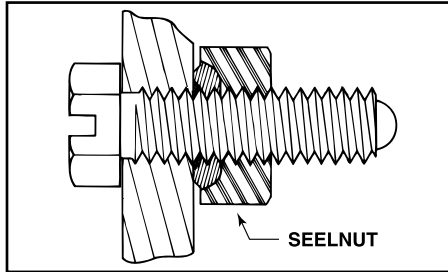

THREAD SIZE	F	H	T
6-32	5/16	9/64	1/64
8-32	11/32	5/32	1/64
10-32	3/8	5/32	1/64
10-24	3/8	5/32	1/64
1/4-20	7/16	7/32	1/64
1/4-28	7/16	7/32	1/64
5/16-18	1/2	17/64	1/64
5/16-24	1/2	17/64	1/64
3/8-16	9/16	21/64	1/64
3/8-24	9/16	21/64	1/64
7/16-20	11/16	3/8	1/64
1/2-13	3/4	27/64	1/32
1/2-20	3/4	27/64	1/32
5/8-18	15/16	35/64	1/32

Metric sizes also available. Please consult factory.

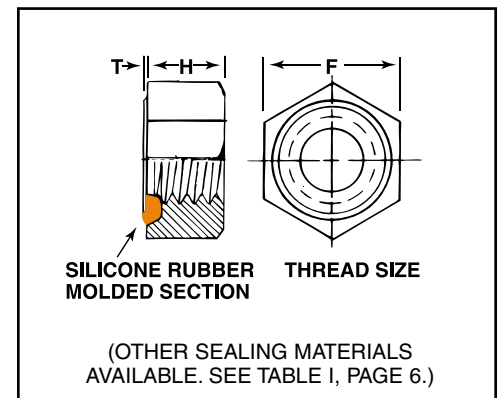

# SEELRIVETS® High-pressure, self-sealing rivets

SEELRIVETS® are designed to seal out air, water, lubricants, and other liquid or gaseous contaminants. Installed like an ordinary rivet, SEELRIVETS® form a high-pressure seal while permitting metal-to-metal contact. Stock SEELRIVETS® are universal head furnished in aluminum alloy for aircraft applications. These Type SRU SEELRIVETS® have the exact dimensions of AN470 and MS20470 rivets. Type SRC, 100° countersunk, flathead versions are also available as non-stock items. Other rivet types/materials and O-ring seal formulations are also available on special order.

## TYPE SRU (available from stock)

A	B	C	LENGTH ± .01*
1/8"	1/4"	.054"	3/16" to 1 1/2" incl.
5/32"	5/16"	.067"	1/4" to 1 3/4" incl.
3/16"	3/8"	.080"	1/4" to 3" incl.
1/4"	1/2"	.107"	3/8" to 3 1/2" incl.
5/16"	5/8"	.133"	1/2" to 4" incl.
3/8"	3/4"	.161"	5/8" to 4" incl.

\*Lengths in multiples of 1/16"

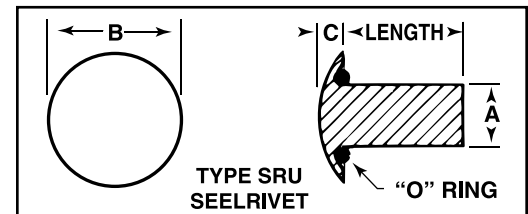

TYPE SRU (Universal Head)

## TYPE SRC (on special order only)

A	D	LENGTH ± .01*
1/8"	15/64"	3/16" to 1 1/2" incl.
5/32"	19/64"	1/4" to 1 3/4" incl.
3/16"	11/32"	1/4" to 3" incl.
1/4"	15/32"	3/8" to 3 1/2" incl.
5/16"	31/64"	1/2" to 4" incl.
3/8"	11/16"	5/8" to 4" incl.

\*Lengths in multiples of 1/16"

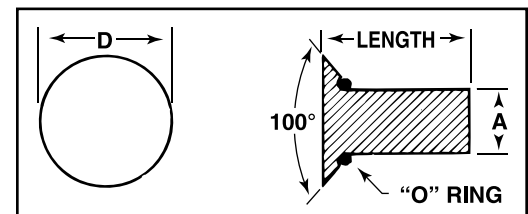

TYPE SRC (Flat Head)

## SEELRIVET® SPECIFICATIONS

**Material:** Aluminum alloy, 2117-T4, anodized finish. O-ring silicone rubber per ZZ-R-765 Class I & II, Grade 70. Other sealing materials available.

**Temperature Range:** -160°F to +500°F (-106°C to +260°C)

**Pressure Range:** Up to 6000 psi, internal and external, subject to installation procedures.

**Shelf Life:** Excess of 25 years.

**Resistant to:** Salt water, weather, dirt, dust, sunlight, ozone and most acids. See Table I.

**Installation:** Install in same manner as standard rivets. Standard break-edge practices for deburring (i.e. break sharp edges 0.005" maximum) are permissible.

## HOW TO ORDER

When ordering SEELRIVETS®, specify head style, rivet diameter and length. Example:

- To order a Type SRU with a 5/32" diameter, 3/4" long, specify:  
SEELRIVET SRU 5/32 x 3/4"

# SEELRINGS™ Molded Elastomeric O-Rings

SEELRINGS™ are standard size O-rings fabricated in your choice of material compatible with your application requirements. For non-standard sizes, or other materials, please consult the factory.

**SIZES AVAILABLE (We are constantly adding new sizes.)**

APM Part No.	APM Part No.	APM Part No.	APM Part No.	APM Part No.	APM Part No.	APM Part No.
064*021	070*070	100*045	152*036	208*055	301*070	
070*040	073*026	112*019	152*049	208*070	321*058	
	079*038	112*059	174*028	237*040	364*070	
	090*047	125*056	177*043	240*025	432*080	
	094*034	130*075	189*059	268*060		
		133*058		290*047		
		143*047				
		145*026				

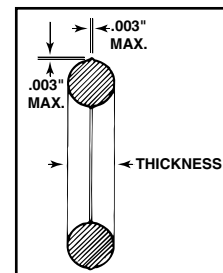
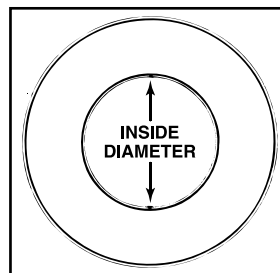

\*Replace asterisk with appropriate letter denoting material required (see O-Ring Materials List below).

**HOW TO ORDER**

SEELRING™ part numbers are based on the actual part dimensions and material. The first three numbers represent the inside diameter (in thousandths of an inch). The last three numbers represent the thickness (in thousandths of an inch). The separating letter denotes the material. Example:

- To order a neoprene O-ring with an inside diameter of 0.079" and a thickness of 0.038", specify: SEELRING 079E038

TABLE I: O-RING MATERIAL LIST											
Letter	Material	Relevant Specifications	Service Temp °F	RESISTANT TO				TYPICAL PROPERTIES			
				Ozone	Chemicals	Oil	Solvents	Tensile PSI	Elongation %	Abrasion Resistance	Compression Set
S	Silicone Rubber	ZZ-R-765 CLASS I & II GR. 70 RED	-150° to 500°	Excellent	Good	Good	Fair	500-1800	100-800	Fair	Excellent
L	Fluoro-Silicone Rubber	MIL-R-25988 AMS 3326	-78° TO 450°	Excellent	Good	Excellent	Good	600-1400	100-700	Fair	Excellent
V	*Viton® A	MIL-R-83248 CLASS I GR. 75	-20° to 400°	Excellent	Excellent	Excellent	Excellent	2000-2200	300-400	Good	Excellent
N	Buna N (NBR)	ASTM D2000-90 M2BG714	-65° to 250°	Fair	Good	Excellent	Good	1500-3000	400-600	Good	Excellent
E	Neoprene (EPR)	MIL-R-3065 AMS3209	-65° to 300°	Good	Good	Good	Fair	1500-4000	100-700	Excellent	Good
F	Ethylene Propylene (EPDM)	ASTM D2000-90 M3BA708	-65° to 300°	Excellent	Excellent	Poor	Good	1400-1600	500-600	Excellent	Excellent
G	Hydrogenated Nitrile	ASTM D2000-90 M2BG714 (Green)	-40° to 275°	Excellent	Excellent	Excellent	Good	2000	170	Good	Excellent

Other materials available. Please consult factory. \* Viton® is a registered trademark of DuPont Performance Elastomers.

## Custom Self-Sealing Fasteners

Self-sealing SEELSKREWS®, SEELBOLTS®, SEELRIVETS® and SEELNUTS® are available in other sizes, lengths, materials, head styles and finishes. These can be produced with an O-ring material (Table I or other) best suited for your application. Should you not find what you need in this catalog, please consult the factory. We would be pleased to work with you to satisfy your specific application requirements.

**Learn more about our other standard and custom products... Ask for these catalogs:**

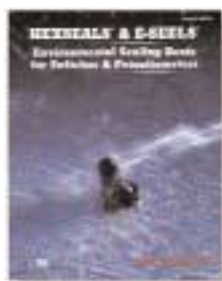

Switch Boots Catalog HEX



Circuit Breaker Boots Catalog CB

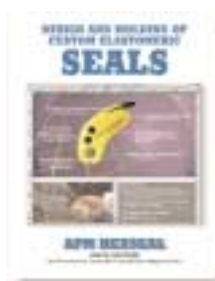

Custom Elastomeric Seals Catalog CS



Incandescent Lamp Colorizing Filters • Catalog SK

## APM HEXSEAL

44 Honeck Street • Englewood NJ 07631 • Tel.: (201) 569-5700 • Fax: (201) 569-4106 • Web: [www.apmhxseal.com](http://www.apmhxseal.com)