

Tactile Switches, .236 [6] x .236 [6], Low Profile, Surface Mount

MATERIAL SPECIFICATIONS:

ContactsCopper Alloy, silver clad plated
 Case MaterialPPS
 StemPPS
 Cover.....Steel, tin-plate
 TerminalsCopper alloy, silver plated

TYPICAL PERFORMANCE CHARACTERISTICS:

Contact Rating50mA @ 12 VDC
 Initial Contact Resistance100 Milliohms max.
 Insulation Resistance100 Megohms min. @ 100 VDC
 Dielectric Strength500 VAC, 1 minute
 Actuation ForceSee Below.
 Life ExpectancyUp to 100,000 Cycles

ENVIRONMENTAL SPECIFICATIONS:

Operating Temperature.....-4°F to +185°F (-20°C to +85°C)
 Storage Temperature.....-22°F to +185°F (-30°C to +85°C)
 Solder Heat ResistanceIR Soldering EIA-364-56
 Procedure 5 Level 2, 464°F (240°C)



FSM1LP

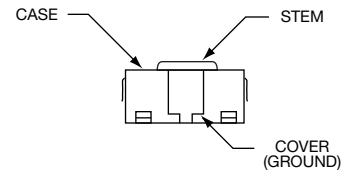
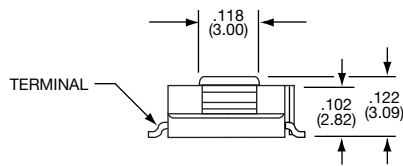
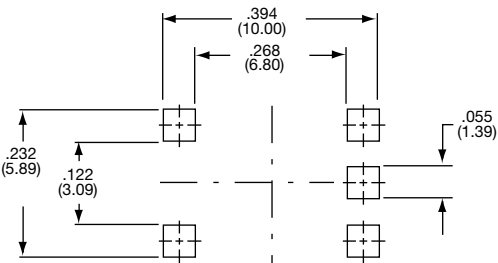
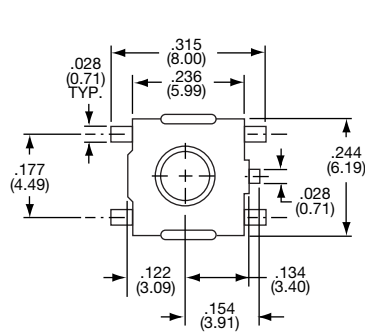

FSM4LP

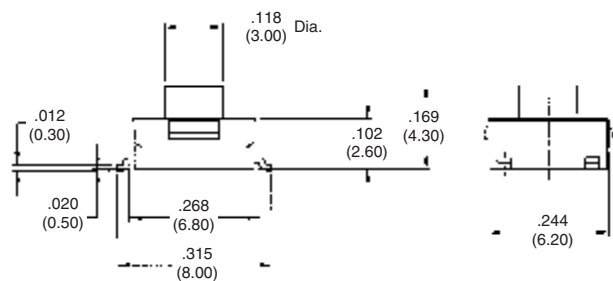
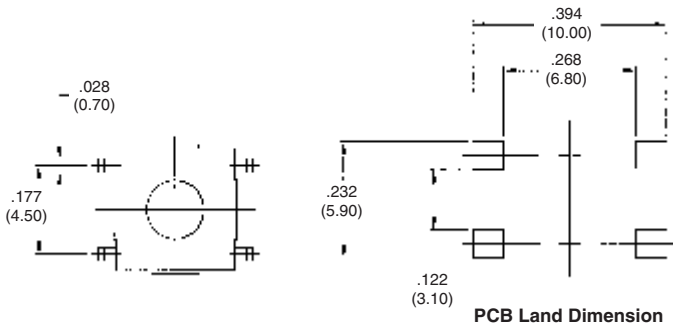

Tyco Electronics	Alcoswitch	Force	Actuator Packaging
1-1437565-6	FSM1LP	160	Bulk
1-1437565-7	FSM1LPA	260	Bulk
1-1437565-9	FSM1LPTR	160	Tape & Reel
1-1437565-8	FSM1LPATR	260	Tape & Reel
1571621-1	FSM4LP	260	Bulk
4-1437565-3	FSM4LPTR	260	Tape & Reel

E
FSM1LP Series

Tactile Switches, .472 [12] x .472 [12], Flush or Extended Actuators

MATERIAL SPECIFICATIONS:

ContactsCopper alloy, silver clad plate
 Case.....PBT
 Actuator ButtonPolyacetal Resin
 Cover.....PET film
 TerminalsCopper alloy, silver plate
 Frame (R/A)Nylon

TYPICAL PERFORMANCE CHARACTERISTICS:

Contact Rating50 mA @ 12 VDC
 Initial Contact Resistance100 Milliohms max.
 Insulation Resistance100 Megohms min. @100 VDC
 Dielectric Strength500 VAC for 1 minute
 Actuation ForceSee below
 Actuator Travel.....0.012"(0.3)
 Life ExpectancyUp to 100,000 cycles

ENVIRONMENTAL SPECIFICATIONS

Operating Temperature.....4°F to +185°F (-20°C to +85°C)
 Storage Temperature.....-22°F to +185°F (-30°C to +85°C)
 Solder Heat ResistanceSee Page M3-4



FSM100

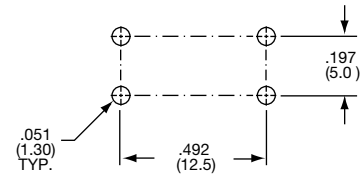
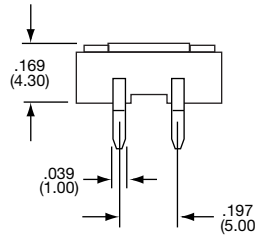
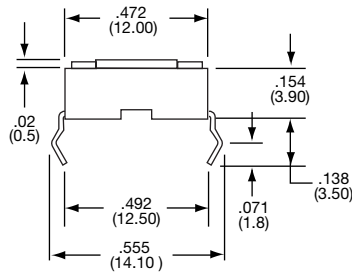
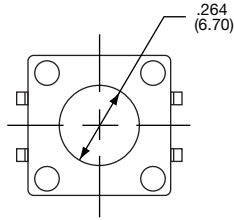

Tyco Electronics	Alcoswitch	Type			Force
1437565-2	FSM100	SPST	Off	(On)	160±50gf
1571139-1	FSM100A	SPST	Off	(On)	260±50gf

(On) indicates momentary position.



FSM101

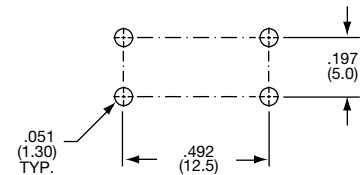
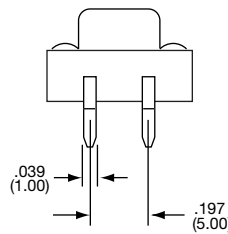
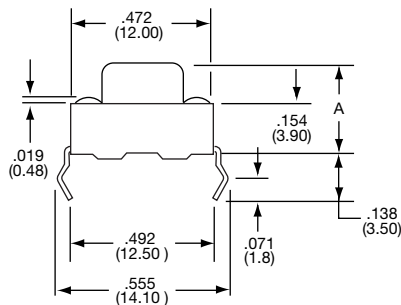
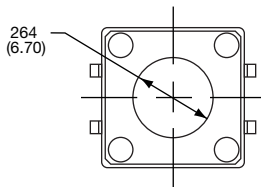

Tyco Electronics	Alcoswitch	Type			Force	Dim A
1437565-3	FSM101	SPST	Off	(On)	160±50gf	.295 [7.5mm]
1571140-1	FSM201A	SPST	Off	(On)	260±50gf	.335 [8.5mm]

(On) indicates momentary position.

E
FSM100-104 Series

Tactile Switches, .472 [12] x .472 [12], Vertical or Right Angle

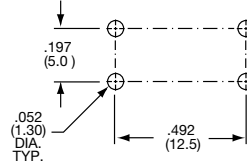
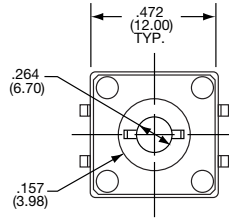
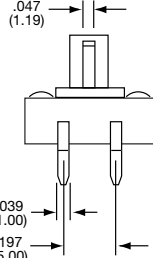
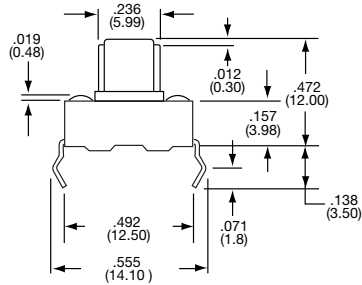

FSM102

Tyco Electronics	Alcoswitch	Type			Force
1437565-4	FSM102	SPST	Off	(On)	160±50gf
1571061-1	FSM102A	SPST	Off	(On)	260±50gf

(On) indicates momentary position.

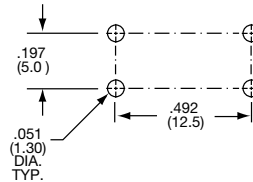
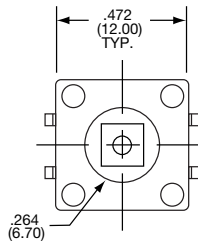
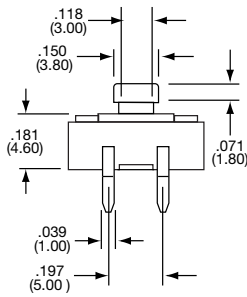
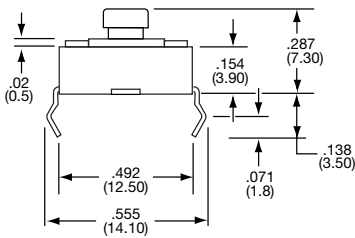

FSM103

Tyco Electronics	Alcoswitch	Type			Force
1437565-5	FSM103	SPST	Off	(On)	160±50gf

(On) indicates momentary position.

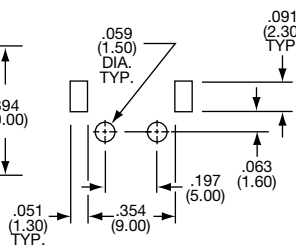
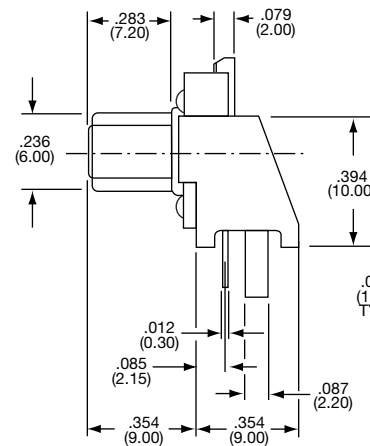
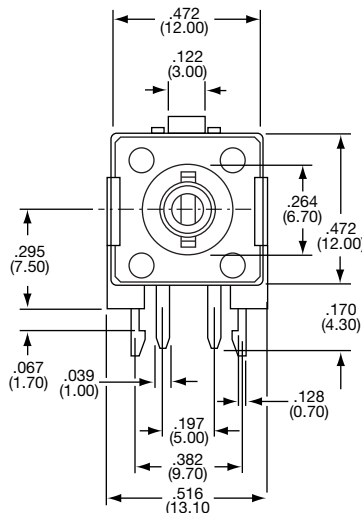

Tyco Electronics	Alcoswitch	Type			Force
1437565-6	FSM104	SPST	Off	(On)	160±50gf

(On) indicates momentary position.

Tactile Switches, Sealed .472 [12] x .472 [12], Surface Mount, Projected Actuator

MATERIAL SPECIFICATIONS:

CaseThermoplastic, UL94V-0, Black
 Stem/ActuatorThermoplastic, UL94V-0, Black
 CoverStainless Steel
 SealSilicone Rubber, Black
 Contact.....Stainless Steel, Plating—Silver
 TerminalCopper Alloy, Plating—Silver/Nickel

TYPICAL PERFORMANCE CHARACTERISTICS:

Contact Rating50mA @ 12 V DC
 Initial Contact Resistance100MilliOhms Max
 Insulation Resistance100Megaohms @ 100VDC Min.
 Dielectric Strength500 VAC
 Actuation Travel.....0.014 +/- .008 (.35 +/- .20)
 LifeUp to 1,000,000 Cycles

ENVIRONMENTAL SPECIFICATIONS:

Operating Temperature-4 to +185°F (-20 to +70°C)
 Storage Temperature-4 to +185°F (-20 to +70°C)
 Resistance to solder heatPer EIA-364-56, Procedure 4 & 5, Level 3
 SolderabilityPer EIA RS-186-9E
 SealPer IP67

E

Sealed Tactile Switches

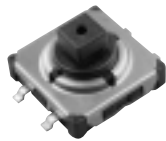
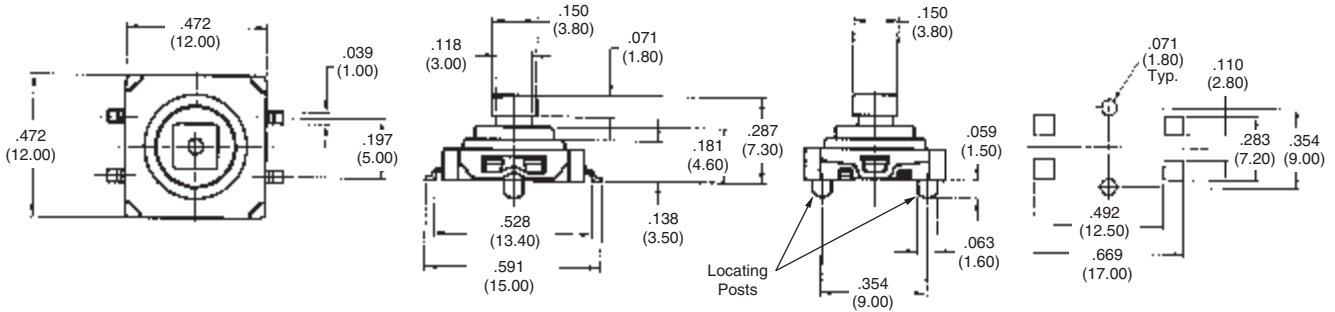

Tyco Electronics	Locating Post	Packaging	Actuator Height	Force
1571217-1	No	Bulk	.287 (7.30)	160±70gf
1571217-2	Yes	Bulk	.287 (7.30)	160±70gf
1571217-3	No	T&R	.287 (7.30)	160±70gf
1571217-4	Yes	T&R	.287 (7.30)	160±70gf

Tactile Switches, Sealed .472 [12] x .472 [12], Surface Mount, Flush, Actuator

MATERIAL SPECIFICATIONS:

CaseThermoplastic, UL94V-0, Black
 Stem/ActuatorThermoplastic, UL94V-0, Black
 CoverStainless Steel
 SealSilicone Rubber, Black
 Contact.....Stainless Steel, Plating—Silver
 TerminalCopper Alloy, Plating—Silver/Nickel

TYPICAL PERFORMANCE CHARACTERISTICS:

Contact Rating50mA @ 12 V DC
 Initial Contact Resistance100MilliOhms Max
 Insulation Resistance100Megaohms @ 100VDC Min.
 Dielectric Strength500 VAC
 Actuation Travel.....0.014 +/- .008 (.35 +/- .20)
 LifeUp to 1,000,000 Cycles

ENVIRONMENTAL SPECIFICATIONS:

Operating Temperature-4 to +185°F (-20 to +85°C)
 Storage Temperature-4 to +185°F (-20 to +85°C)
 Resistance to solder heatPer EIA-364-56, Procedure 4 & 5, Level 3
 SolderabilityPer EIA RS-186-9E
 SealPer IP67

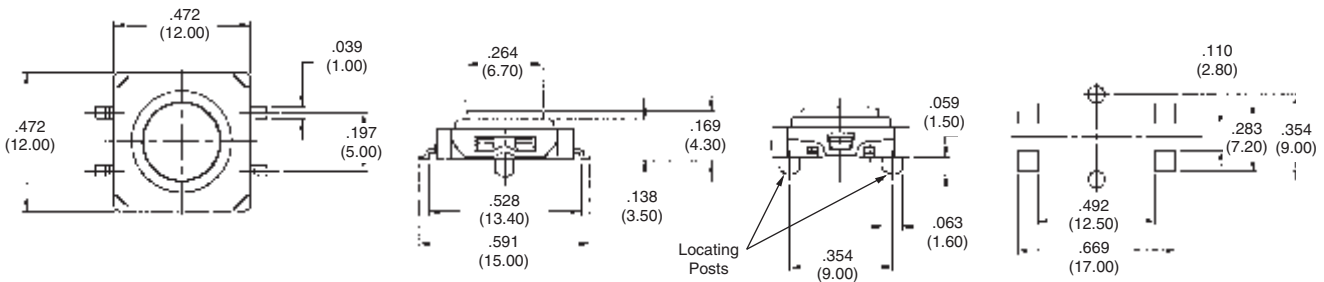

Tyco Electronics	Locating Post	Packaging	Actuator Height	Force
1571218-1	No	Bulk	.169 (4.30)	160±70gf
1571218-2	Yes	Bulk	.169 (4.30)	160±70gf
1571218-3	No	T&R	.169 (4.30)	160±70gf
1571218-4	Yes	T&R	.169 (4.30)	160±70gf

E
Sealed Tactile Switches

Tactile Switches, Sealed .472 [12] x .472 [12], Thru-Hole, Projected Actuator

MATERIAL SPECIFICATIONS:

CaseThermoplastic, UL94V-0, Black
 Stem/ActuatorThermoplastic, UL94V-0, Black
 CoverStainless Steel
 SealSilicone Rubber, Black
 Contact.....Stainless Steel, Plating—Silver
 TerminalCopper Alloy, Plating—Silver/Nickel

TYPICAL PERFORMANCE CHARACTERISTICS:

Contact Rating50mA @ 12 V DC
 Initial Contact Resistance100MilliOhms Max
 Insulation Resistance100Megaohms @ 100VDC Min.
 Dielectric Strength500 VAC
 Actuation Travel.....0.014 +/-0.008 (.35 +/- .20)
 Life1,000,000 Cycles

ENVIRONMENTAL SPECIFICATIONS:

Operating Temperature-4 to +185°F (-20 to +85°C)
 Storage Temperature-4 to +185°F (-20 to +85°C)
 Resistance to solder heatPer EIA-364-56, Procedure 3, Test Cond. B
 SolderabilityPer EIA RS-186-9E
 SealPer IP67

E

Sealed Tactile Switches

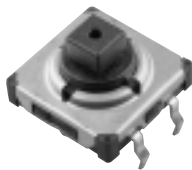
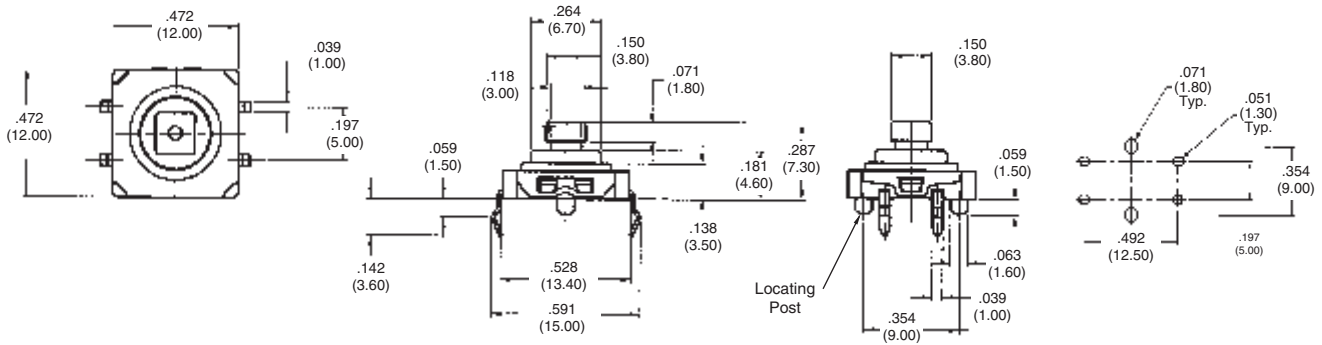

Tyco Electronics	Locating Post	Packaging	Actuator Height	Force
1571219-1	No	Bulk	.287 (7.30)	160±70gf
1571219-2	Yes	Bulk	.287 (7.30)	160±70gf

Tactile Switches, Sealed .472 [12] x .472 [12], Thru-Hole, Flush Actuator

MATERIAL SPECIFICATIONS:

CaseThermoplastic, UL94V-0, Black
 Stem/ActuatorThermoplastic, UL94V-0, Black
 CoverStainless Steel
 SealSilicone Rubber, Black
 Contact.....Stainless Steel, Plating—Silver
 TerminalCopper Alloy, Plating—Silver/Nickel

TYPICAL PERFORMANCE CHARACTERISTICS:

Contact Rating50mA @ 12 V DC
 Initial Contact Resistance100MilliOhms Max
 Insulation Resistance100Megaohms @ 100VDC Min.
 Dielectric Strength500 VAC
 Actuation Travel.....0.014 +/-0.008 (.35 +/- .20)
 Life1,000,000 Cycles

ENVIRONMENTAL SPECIFICATIONS:

Operating Temperature-4 to +185°F (-20 to +85°C)
 Storage Temperature-4 to +185°F (-20 to +85°C)
 Resistance to solder heatPer EIA-364-56, Procedure 3, Test Cond. B
 SolderabilityPer EIA RS-186-9E
 SealPer IP67

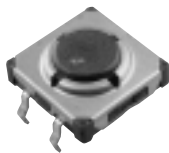
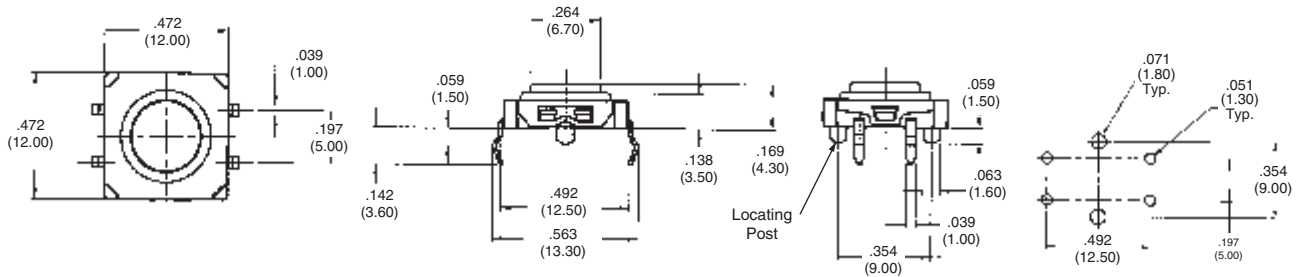

Tyco Electronics	Locating Post	Packaging	Actuator Height	Force
1571220-1	No	Bulk	.169 (4.30)	160±70gf
1571220-2	Yes	Bulk	.169 (4.30)	160±70gf

E
Sealed Tactile Switches

Tactile Switches, Sealed .299 [7.6] x .287 [7.3], Surface Mount, Extended Actuator

MATERIAL SPECIFICATIONS:

CaseThermoplastic, UL94V-0, Black
 Stem/ActuatorThermoplastic, UL94V-0, Black
 CoverStainless Steel
 SealSilicone Rubber, Black
 Contact.....Stainless Steel, Plating—Silver
 TerminalCopper Alloy, Plating—Silver

TYPICAL PERFORMANCE CHARACTERISTICS:

Contact Rating50mA @ 12 V DC
 Initial Contact Resistance100MilliOhms Max
 Insulation Resistance100Megaohms @ 100VDC Min.
 Dielectric Strength500 VAC
 Actuation Travel.....0.014 +/- .008 (.35 +/- .20)
 LifeUp to 1,000,000 Cycles

ENVIRONMENTAL SPECIFICATIONS:

Operating Temperature-4 to +185°F (-20 to +85°C)
 Storage Temperature-4 to +185°F (-20 to +85°C)
 Resistance to solder heatPer EIA-364-56, Procedure 4 & 5, Level 3
 SolderabilityPer EIA RS-186-9E
 SealPer IP67

E

Sealed Tactile Switches

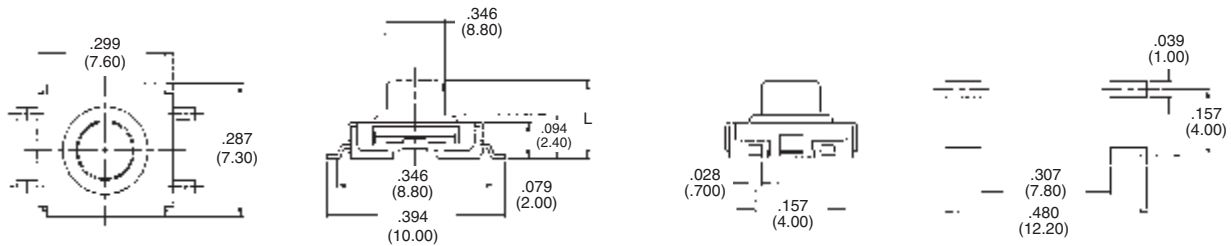

Tyco Electronics	Packaging	L	Force
1571294-1	Bulk	.169 (4.30)	160±50gf
1571294-2	T&R	.169 (4.30)	160±50gf
1571294-3	Bulk	.197 (5.00)	160±50gf
1571294-4	T&R	.197 (5.00)	160±50gf

Tactile Switches, Sealed .299 [7.6] x .287 [7.3], Surface Mount, Flush Actuator

MATERIAL SPECIFICATIONS:

CaseThermoplastic, UL94V-0, Black
 Stem/ActuatorThermoplastic, UL94V-0, Black
 CoverStainless Steel
 SealSilicone Rubber, Black
 Contact.....Stainless Steel, Plating—Silver
 TerminalCopper Alloy, Plating—Silver/Nickel

TYPICAL PERFORMANCE CHARACTERISTICS:

Contact Rating50mA @ 12 V DC
 Initial Contact Resistance100MilliOhms Max
 Insulation Resistance100Megaohms @ 100VDC Min.
 Dielectric Strength500 VAC
 Actuation Travel.....0.014 +/- .008 (.35 +/- .20)
 LifeUp to 1,000,000 Cycles

ENVIRONMENTAL SPECIFICATIONS:

Operating Temperature-4 to +185°F (-20 to +85°C)
 Storage Temperature-4 to +185°F (-20 to +85°C)
 Resistance to solder heatPer EIA-364-56, Procedure 4 & 5, Level 3
 SolderabilityPer EIA RS-186-9E
 SealPer IP67

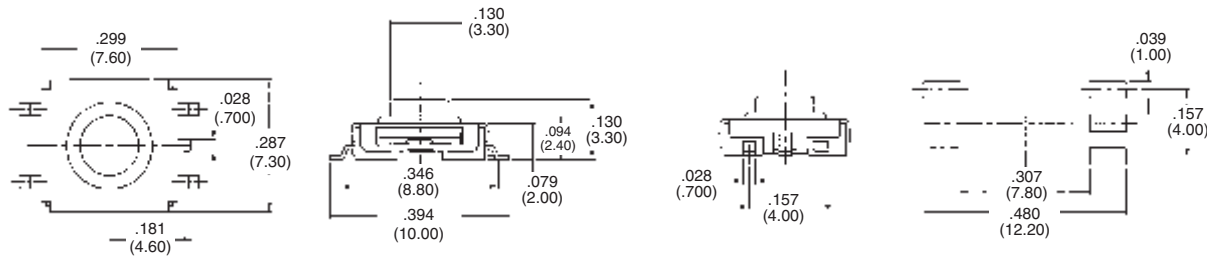

Tyco Electronics	Packaging	Actuator Height	Force
1571296-1	Bulk	.130 (3.30)	160±50gf
1571296-2	T&R	.130 (3.30)	160±50gf

E
Sealed Tactile Switches

Tactile Switches, Sealed .299 [7.6] x .287 [7.3], Thru-Hole, Extended Actuator

MATERIAL SPECIFICATIONS:

CaseThermoplastic, UL94V-0, Black
 ActuatorThermoplastic, UL94V-0, Black
 CoverStainless Steel
 SealSilicone Rubber, Black
 Contact.....Stainless Steel, Plating—Silver
 TerminalCopper Alloy, Plating—Silver/Nickel

TYPICAL PERFORMANCE CHARACTERISTICS:

Contact Rating50mA @ 12 V DC
 Initial Contact Resistance100MilliOhms Max
 Insulation Resistance100Megaohms @ 100VDC Min.
 Dielectric Strength500 VAC
 Actuation Travel0.014 +/-0.008 (.35 +/- .20)
 LifeUp to 1,000,000 Cycles

ENVIRONMENTAL SPECIFICATIONS:

Operating Temperature-4 to +185°F (-20 to +85°C)
 Storage Temperature-4 to +185°F (-20 to +85°C)
 Resistance to solder heatPer EIA-364-56, Procedure 3, Test Cond.B
 SolderabilityPer EIA RS-186-9E
 SealPer IP67

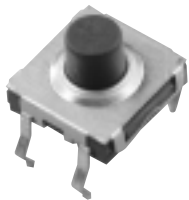
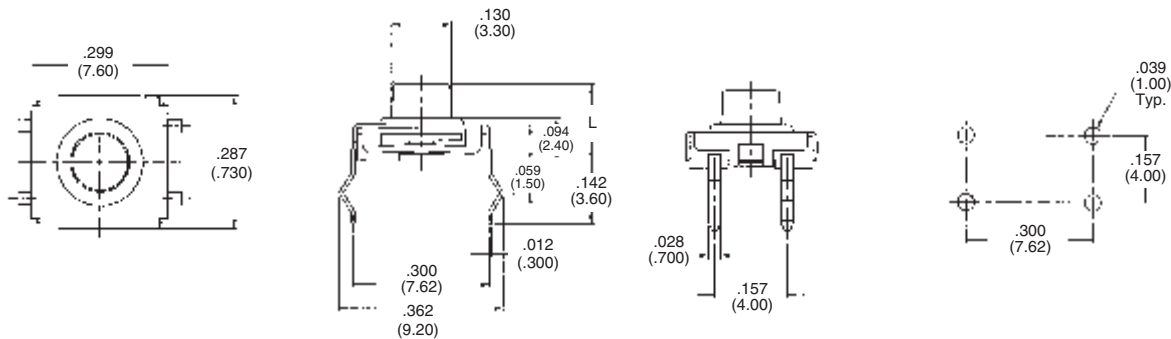

Tyco Electronics	Packaging	L	Force
1571295-1	Bulk	.169 (4.30)	160±50gf
1571295-2	Bulk	.197 (5.00)	160±50gf

E
Sealed Tactile Switches

Tactile Switches, Sealed .185 [4.7] x .268 [6.8], Surface Mount

MATERIAL SPECIFICATIONS:

CaseThermoplastic, UL94V-0, Black
 Stem/ActuatorThermoplastic, UL94V-0, Black
 CoverStainless Steel
 SealSilicone Rubber, Black
 Contact.....Stainless Steel, Plating—Silver
 TerminalCopper Alloy, Plating—Silver/Nickel

TYPICAL PERFORMANCE CHARACTERISTICS:

Contact Rating50mA @ 12 V DC
 Initial Contact Resistance100MilliOhms Max
 Insulation Resistance100Megaohms @ 100VDC Min.
 Dielectric Strength500 VAC
 Actuation Travel.....0.014 +/-0.008 (.35 +/- .20)
 LifeUp to 50,000 Cycles

ENVIRONMENTAL SPECIFICATIONS:

Operating Temperature-4 to +185°F (-20 to +85°C)
 Storage Temperature-4 to +185°F (-20 to +85°C)
 Resistance to solder heatPer EIA-364-56, Procedure 4 & 5, Level 3
 SolderabilityPer EIA RS-186-9E
 SealPer IP67

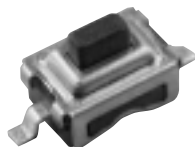
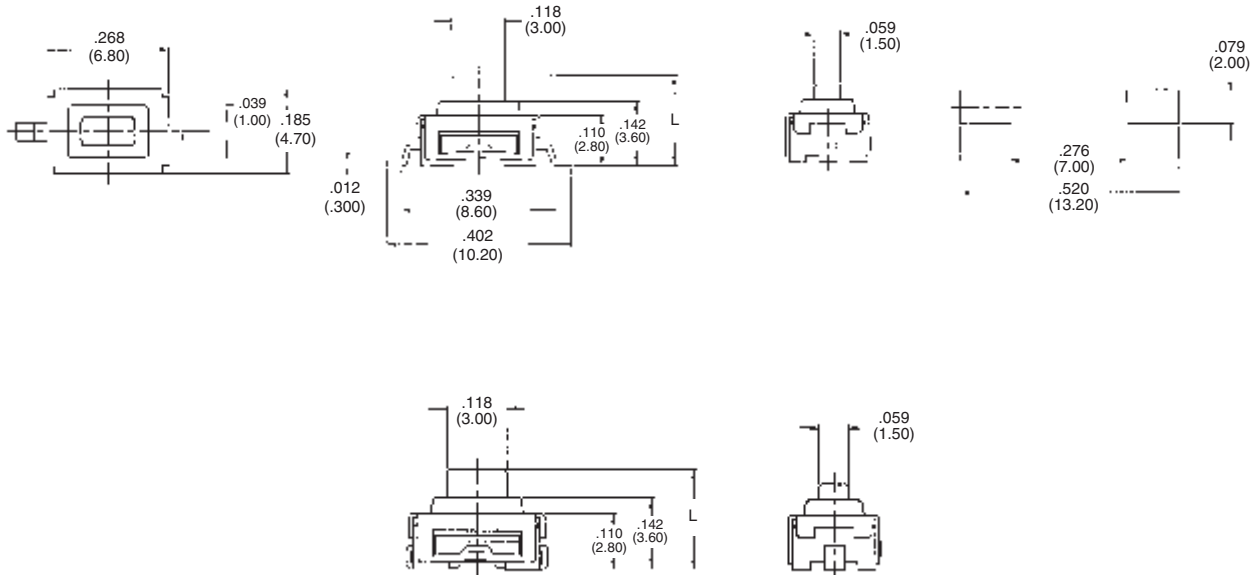

Tyco Electronics	Packaging	L	Operating Force	Lead Style
1571298-1	Bulk	.197 (5.00)	130 ± 50gf	Gull Wing
1571298-2	T&R	.197 (5.00)	130 ± 50gf	Gull Wing
1571299-1	Bulk	.169 (4.30)	130 ± 50gf	J Lead
1571299-2	T&R	.169 (4.30)	130 ± 50gf	J Lead
1571299-3	Bulk	.197 (5.00)	130 ± 50gf	J Lead
1571299-4	T&R	.197 (5.00)	130 ± 50gf	J Lead