

# SNAP Digital Output Modules

## Features

- Four channels per module
- Convenient pluggable wiring terminals; accepts up to 14 AWG wire
- Powered by a single 5-volt supply
- Channel-specific LEDs
- Operating temperature: 0 to 70 °C
- UL and CE approved (most modules); Factory Mutual approved (part numbers ending in FM)



SNAP Digital Output Modules

## Description

Opto 22 SNAP I/O digital output modules are part of the SNAP PAC System.

Customers can choose from AC or DC models. Optical isolation on all solid-state modules provides 4,000 volts of transient (4000 V for 1 ms) protection for sensitive control electronics from industrial field signals.

All SNAP digital modules have removable top-mounted connectors to provide easy access for field wiring. All operate on 5 VDC control logic. Each digital module features integral channel-specific LEDs for convenient troubleshooting and maintenance.

Each module is factory tested twice before shipment, and most modules are UL and CE approved. In addition, part numbers ending in FM are Factory Mutual approved.

SNAP output modules are used to switch up to four separate AC or DC loads. Output modules that are fused use a standard fuse with a convenient handle for easy replacement. DC outputs are available in either a source or sink configuration. AC outputs are zero voltage turn on and zero current turn off for transient-free switching.

The dry contact modules allow switching of low power signals where signal integrity must be maintained, or where

## Part Numbers

Part	Description	See pages
SNAP-OAC5	SNAP 4-channel 12–250 VAC output, 5 VDC logic	3, 5
SNAP-OAC5MA	SNAP 4-channel isolated 12–250 VAC output, 5 VDC logic with manual/auto switches	3, 6
SNAP-OAC5FM	SNAP 4-channel 12–250 VAC output, 5 VDC logic	4, 5
SNAP-OAC5-i	SNAP 4-channel isolated 12–250 VAC output, 5 VDC logic	3, 7
SNAP-OAC5-iFM	SNAP 4-channel isolated 12–250 VAC output, 5 VDC logic	4, 7
SNAP-ODC5SRC	SNAP 4-channel 5–60 VDC output, 5 VDC logic source	8, 12
SNAP-ODC5SRCFM	SNAP 4-channel 5–60 VDC output, 5 VDC logic source	10, 12
SNAP-ODC5SNK	SNAP 4-channel 5–60 VDC output, 5 VDC logic sink	8, 13
SNAP-ODC5SNKFM	SNAP 4-channel 5–60 VDC output, 5 VDC logic sink	10, 13
SNAP-ODC5ASNK	SNAP 4-channel 5–200 VDC output, 5 VDC logic sink	9, 13
SNAP-ODC5R*	SNAP 4-channel dry contact output, normally open	8, 14
SNAP-ODC5RFM*	SNAP 4-channel dry contact output, normally open	10, 14
SNAP-ODC5R5*	SNAP 4-channel dry contact output, normally closed	8, 14
SNAP-ODC5R5FM*	SNAP 4-channel dry contact output, normally closed	10, 14
SNAP-ODC5MA	SNAP 4-channel isolated 5–60 VDC output, 5 VDC logic with manual/auto switches	9, 15
SNAP-ODC5-i	SNAP 4-channel isolated 5–60 VDC output, 5 VDC logic	9, 16
SNAP-ODC5-iFM	SNAP 4-channel isolated 5–60 VDC output, 5 VDC logic	11, 16
SNAP-ODC5A-i	SNAP 4-channel isolated 5–200 VDC output, 5 VDC logic	9, 16
SNAP-ODC5A-iFM	SNAP 4-channel isolated 5–200 VDC output, 5 VDC logic	11, 16
SNAP-RETN4	SNAP 4-module retention rail (OEM)	-----
SNAP-RETN4B	SNAP 4-module retention rail, 25-pack (OEM)	-----
SNAP-RETN6	SNAP 6-module retention rail (OEM)	-----
SNAP-RETN6B	SNAP 6-module retention rail, 25-pack (OEM)	-----
SNAP-FUSE4AB	SNAP 4-amp fuse, 25-pack	-----
SNAP-MODFUSEH	SNAP digital output module fuse holder, 10-pack	-----

\*Not UL approved

zero leakage current is a requirement. Dry contact modules are not solid-state devices. They use reed relays, which are electromechanical devices. These modules do not provide optical isolation. Current rating for dry contact modules depends on the voltage they are used with, as shown in the graph on [page 14](#).

SNAP-OAC5MA and SNAP-ODC5MA are special modules featuring manual-on/manual-off/automatic switches, ideal for diagnostic testing of control applications. The switches override output from the application, so you can quickly check field device wiring. These modules each contain four isolated channels.

The SNAP-OAC5-i, SNAP-ODC5-i, and SNAP-ODC5A-i modules provide four isolated output channels.

For Ethernet-based applications requiring higher density of digital I/O points, see Opto 22 form #1556, the *SNAP High-Density Digital Module Data Sheet*.

### I/O Processor Compatibility

SNAP digital output modules are compatible with all SNAP PAC brains and rack-mounted controllers, including both standard wired models and Wired+Wireless™ models.

**Notes for legacy hardware:** SNAP digital output modules are also compatible with SNAP Ultimate, SNAP Ethernet, and SNAP Simple brains, as well as other SNAP brains such as the serial B3000 and the B3000HA. These modules can also be used on B-series and M-series mounting racks.

## Installation

The following diagram shows part of a SNAP mounting rack. The rack is shown without screw connectors.

Modules snap securely into place in the row of connectors on the rack. Each module connector has a number. Digital output modules and other types of SNAP I/O modules are mounted on the module connectors starting at module position zero.

**NOTE:** Check the data sheet or user's guide for the brain or on-the-rack controller you are using to determine module features available and any restrictions on module placement.

## SNAP Digital Output Modules

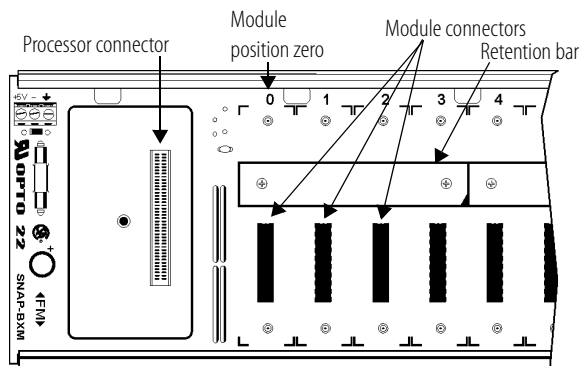

1. Place the rack so that the module connector numbers are right-side up, with zero on the left, as shown in the diagram above. (If your rack has screw connectors, the screw connectors will be at the bottom.)
2. Position the module over the module connector, aligning the small slot at the base of the module with the retention bar on the rack. When positioning modules next to each other, be sure to align the male and female module keys at the tops of the modules before snapping a module into position.
3. With the module correctly aligned, push on the module to snap it into place.
4. (Optional) Use standard 4-40 x 1/2 truss-head Phillips hold-down screws to secure both sides of each module.  
**CAUTION:** Do not over-tighten screws.
5. Follow the wiring diagrams beginning on [page 5](#) to attach modules to the devices they monitor.

Modules require a special tool (provided) for removal.

# SNAP Digital Output Modules

## Specifications—AC Modules

	SNAP-OAC5	SNAP-OAC5MA	SNAP-OAC5-i
Key Feature	--	Diagnostic switches Four isolated channels	Four isolated channels
<b>Field Side Ratings (each channel)</b>			
Line Voltage - Range	24–250 VAC	24–250 VAC	24–250 VAC
Line Voltage - Nominal	120/240 VAC	120/240 VAC	120/240 VAC
Current Rating 0 °C to 70 °C Ambient	3 amps per module	3 amps per module	3 amps per module
One Cycle Surge	80 amps peak (50/60 Hz)	80 amps peak (50/60 Hz)	80 amps peak (50/60 Hz)
Minimum Load Current	20 mA	20 mA	20 mA
Output Voltage Drop	1.6 volts max. @ 0.75 amps	1.6 volts max. @ 0.75 amps	1.6 volts max. @ 0.75 amps
Off-state Leakage at Nominal Voltage - 60 Hz	2.5 mA @ 240 VAC 1.25 mA @ 120 VAC	2.5 mA @ 240 VAC 1.25 mA @ 120 VAC	2.5 mA @ 240 VAC 1.25 mA @ 120 VAC
Peak Blocking Voltage	500 V	500 V	500 V
Operating Frequency	25–65 Hz	25–65 Hz	25–65 Hz
dV/ dt - Off-state	200 volts/msec	200 volts/msec	200 volts/msec
dV/ dt - Commutating	Snubbed for rated 0.5 power factor load	Snubbed for rated 0.5 power factor load	Snubbed for rated 0.5 power factor load
Fuse (Common to all Channels)	250 VAC - 4A 5x20 mm Fast-acting Bell Fuse Part No. BEL 5HF4 Opto 22 Part No. SNAP-4A	Has four isolated channels. User must provide own fusing.	Has four isolated channels. User must provide own fusing.
Channel-to-channel isolation	Not applicable	300 VAC (1500 V transient)	300 VAC (1500 V transient)
<b>Logic Side Ratings</b>			
Pickup Voltage	4 V @ 5.5 mA	4 V @ 5.5 mA	4 V @ 5.5 mA
Dropout Voltage	1 VDC	1 VDC	1 VDC
Control Resistance	220 ohms	220 ohms	220 ohms
Logic Supply Voltage	5 VDC ± 0.25 VDC	5 VDC ± 0.25 VDC	5 VDC ± 0.25 VDC
Logic Supply Current	50 mA maximum	50 mA maximum	50 mA maximum
<b>Module Ratings</b>			
Number of Channels Per Module	4	4	4
Turn-on Time	0.5 cycle maximum (zero volts crossover)	0.5 cycle maximum (zero volts crossover)	0.5 cycle maximum (zero volts crossover)
Turn-off Time	0.5 cycle maximum (zero current crossover)	0.5 cycle maximum (zero current crossover)	0.5 cycle maximum (zero current crossover)
Isolation (Field Side to Logic Side)	4,000 volts (transient)	4,000 volts (transient)	4,000 volts (transient)
Temperature	0 ° to 70 °C, operating -30 ° to 85 °C, storage	0 ° to 70 °C, operating -30 ° to 85 °C, storage	0 ° to 70 °C, operating -30 ° to 85 °C, storage
Agency Approvals	UL, CE, CSA, RoHS, DFARS	UL, CE, RoHS, DFARS	UL, CE, RoHS, DFARS
Warranty	Lifetime	30 months	Lifetime

# SNAP Digital Output Modules

## Specifications—AC Modules (continued)

	SNAP-OAC5-FM	SNAP-OAC5-i-FM
Key Feature	Factory Mutual approved	Four isolated channels Factory Mutual approved
<b>Field Side Ratings (each channel)</b>		
Line Voltage - Range	24–250 VAC	24–250 VAC
Line Voltage - Nominal	120/240 VAC	120/240 VAC
Current Rating 0 °C to 70 °C Ambient	3 amps per module	3 amps per module
One Cycle Surge	80 amps peak (50/60 Hz)	80 amps peak (50/60 Hz)
Minimum Load Current	20 mA	20 mA
Output Voltage Drop	1.6 volts max. @ 0.75 amps	1.6 volts max. @ 0.75 amps
Off-state Leakage at Nominal Voltage - 60 Hz	2.5 mA @ 240 VAC 1.25 mA @ 120 VAC	2.5 mA @ 240 VAC 1.25 mA @ 120 VAC
Peak Blocking Voltage	500 V	500 V
Operating Frequency	25–65 Hz	25–65 Hz
dV/ dt - Off-state	200 volts/msec	200 volts/msec
dV/ dt - Commutating	Snubbed for rated 0.5 power factor load	Snubbed for rated 0.5 power factor load
Fuse (Common to all Channels)	250 VAC - 4A 5x20 mm Fast-acting Bell Fuse Part No. BEL 5HF4 Opto 22 Part No. SNAP-4A	Has four isolated channels. User must provide own fusing.
Channel-to-channel isolation	Not applicable	300 VAC (1500 V transient)
<b>Logic Side Ratings</b>		
Pickup Voltage	4 V @ 5.5 mA	4 V @ 5.5 mA
Dropout Voltage	1 VDC	1 VDC
Control Resistance	220 ohms	220 ohms
Logic Supply Voltage	5 VDC ± 0.25 VDC	5 VDC ± 0.25 VDC
Logic Supply Current	50 mA maximum	50 mA maximum
<b>Module Ratings</b>		
Channels Per Module	4	4
Turn-on Time	0.5 cycle maximum (zero volts crossover)	0.5 cycle maximum (zero volts crossover)
Turn-off Time	0.5 cycle maximum (zero current crossover)	0.5 cycle maximum (zero current crossover)
Isolation (Field Side to Logic Side)	4,000 volts (transient)	4,000 volts (transient)
Temperature	0 ° to 70 °C, operating -30 ° to 85 °C, storage	0 ° to 70 °C, operating -30 ° to 85 °C, storage
Agency Approvals	CE, FM, RoHS, DFARS	CE, FM, RoHS, DFARS
Warranty	Lifetime	Lifetime

# SNAP Digital Output Modules

## Schematics

### SNAP-OAC5 Output Module

Part Number	Description
SNAP-OAC5	4-channel AC output 12–250 VAC 5 VDC logic
SNAP-OAC5FM	4-channel AC output 12–250 VAC 5 VDC logic, Factory Mutual approved

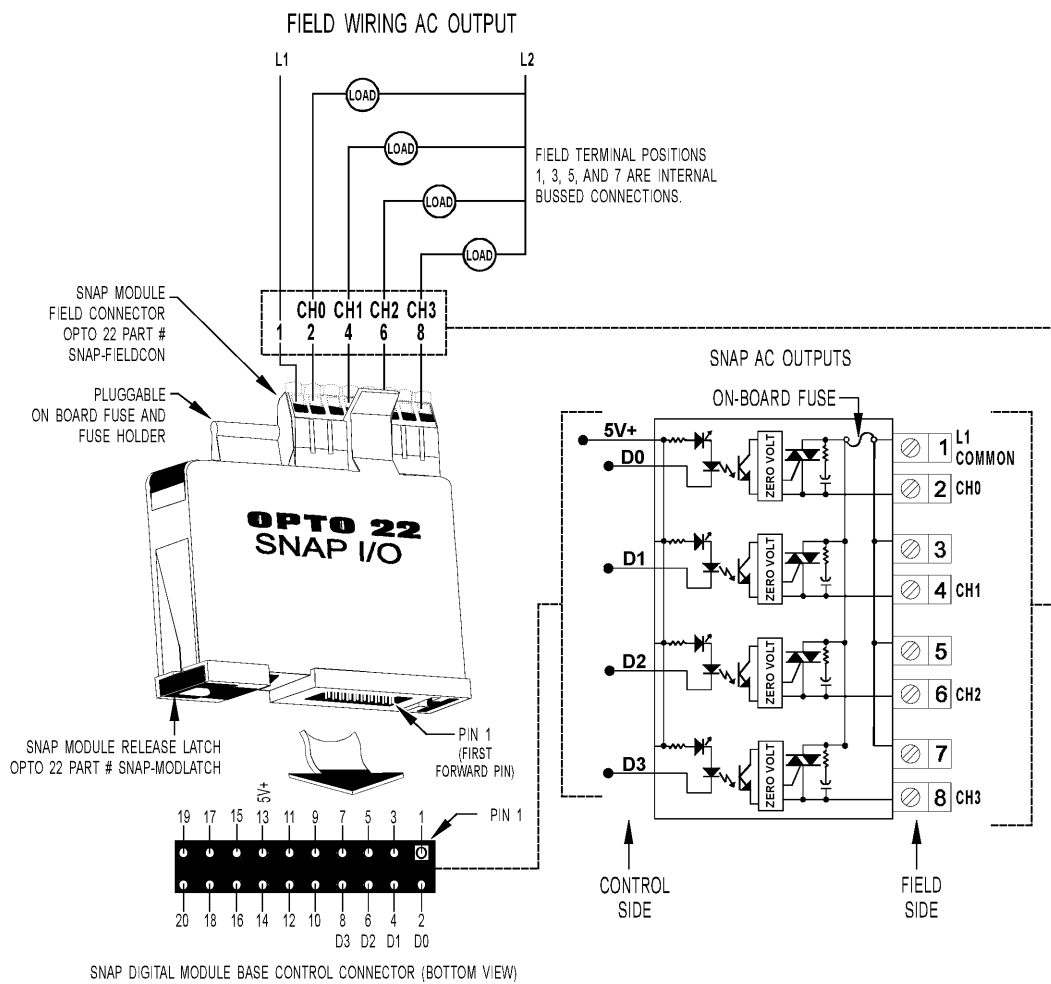

# SNAP Digital Output Modules

## Schematics

### SNAP-OAC5MA Output Module With Manual/Auto Switches

Part Number	Description
SNAP-OAC5MA	4-channel isolated AC output 12–250 VAC, 5 VDC logic, with manual/auto switch

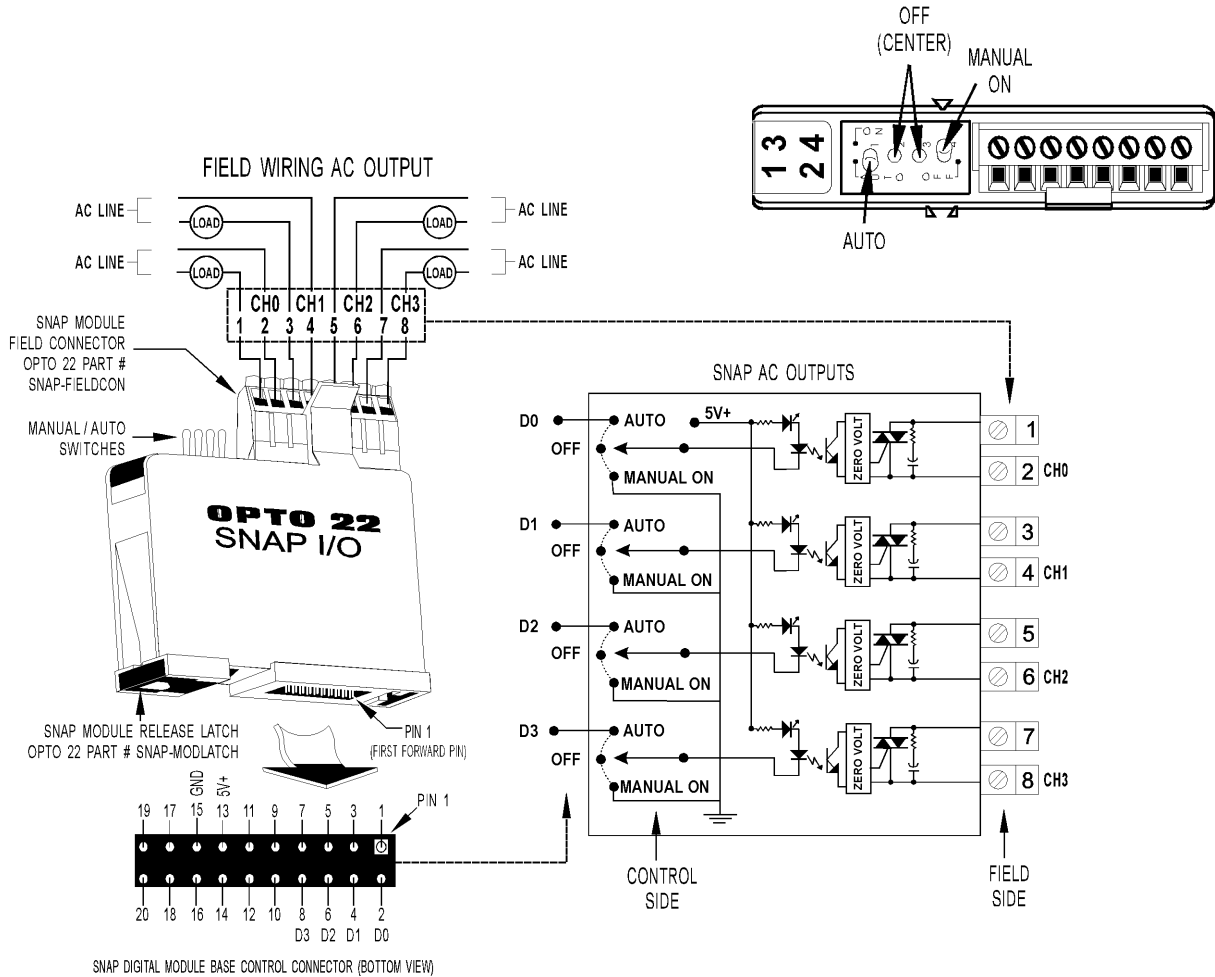

# SNAP Digital Output Modules

## Schematics

### SNAP-OAC5i Isolated Output Module

Part Number	Description
SNAP-OAC5-i	4-channel isolated AC output 12–250 VAC, 5 VDC logic
SNAP-OAC5-IFM	4-channel isolated AC output 12–250 VAC, 5 VDC logic, Factory Mutual approved

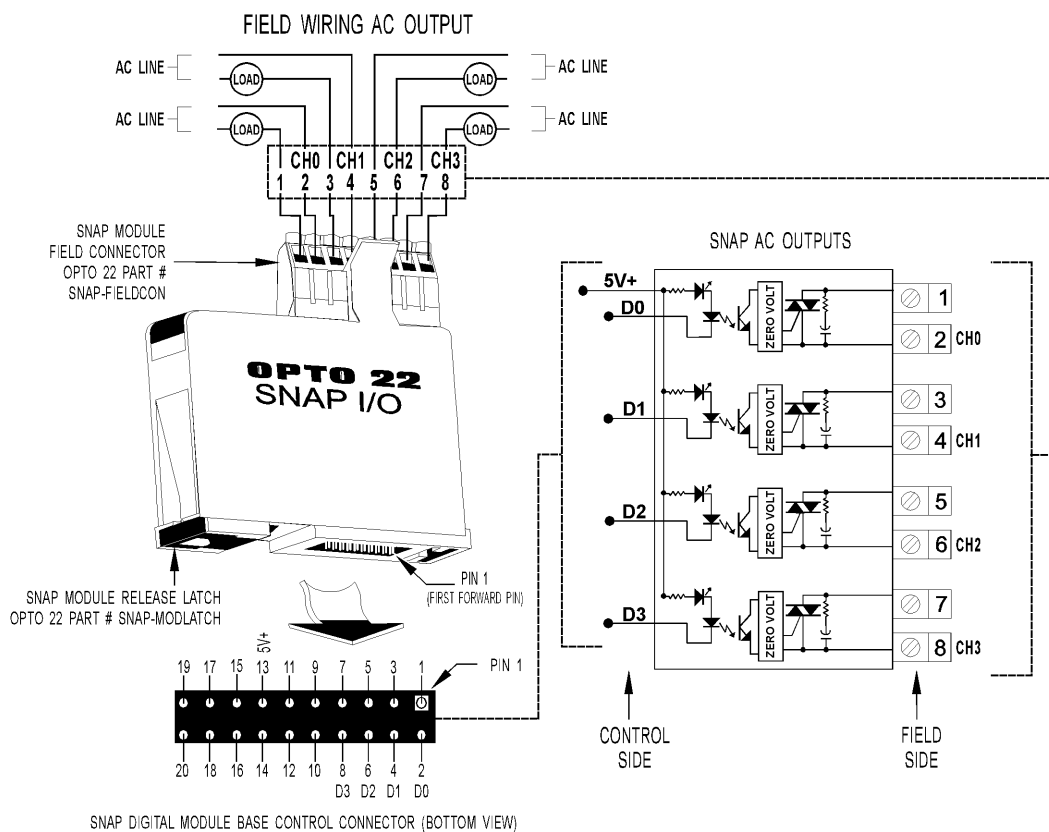

# SNAP Digital Output Modules

## Specifications—DC Modules

	SNAP-ODC5SRC	SNAP-ODC5SNK	SNAP-ODC5R	SNAP-ODC5R5
Key Feature	Load sourcing	Load sinking	Dry contact Normally open	Dry contact Normally closed
<b>Field Side Ratings (each channel)</b>				
Line Voltage - Range	5–60 VDC	5–60 VDC	0–100 VDC 0–130 VAC*	0–100 VDC 0–130 VAC*
Line Voltage - Nominal	5–48 VDC	5–48 VDC	--	--
Current Rating 0 °C to 70 °C Ambient	3 amps per module	3 amps per module	0.5 amps switching*	0.5 amps switching*
Surge Current	5 amps peak for 1 second	5 amps peak for 1 second	0.5 amps*	0.5 amps*
Minimum Load	20 mA	20 mA	0 mA	0 mA
Output Voltage Drop	1.6 volts max. @ 0.75 amps	1.6 volts max. @ 0.75 amps	0 volts	0 volts
Off-state Leakage	1 mA @ 60 VDC	1 mA @ 60 VDC	0 mA	0 mA
Peak Blocking Voltage	60 VDC	60 VDC	100 VDC / 130 VAC	100 VDC / 130 VAC
Fuse (Common to all Channels)	250 VAC - 4A 5x20 mm Fast-acting Bell Fuse Part No. BEL 5HF4 Opto 22 Part SNAP-4A	250 VAC - 4A 5x20 mm Fast-acting Bell Fuse Part No. BEL 5HF4 Opto 22 Part SNAP-4A	Has four isolated channels. User must provide own fusing.	Has four isolated channels. User must provide own fusing.
Channel-to-channel isolation	Not applicable	Not applicable	300 VAC (1500 V transient)	300 VAC (1500 V transient)
<b>Logic Side Ratings</b>				
Pickup Voltage	4 V @ 5.5 mA	4 V @ 5.5 mA	4 V @ 5.5 mA	4 V @ 5.5 mA
Dropout Voltage	1 VDC	1 VDC	1 VDC	1 VDC
Control Resistance	220 ohms	220 ohms	220 ohms	220 ohms
Logic Supply Voltage	5 VDC ± 0.25 VDC	5 VDC ± 0.25 VDC	5 VDC ± 0.25 VDC	5 VDC ± 0.25 VDC
Logic Supply Current	50 mA maximum	50 mA maximum	50 mA maximum	50 mA maximum
<b>Module Ratings</b>				
Number of Channels Per Module	4	4	4	4
Turn-on Time	100 usec	100 usec	500 usec	500 usec
Turn-off Time	750 usec	750 usec	500 usec	500 usec
Isolation (Field Side to Logic Side)	4,000 volts (transient)	4,000 volts (transient)	1,500 volts (transient)	1,500 volts (transient)
Temperature	0 ° to 70 °C, operating -30 ° to 85 °C, storage	0 ° to 70 °C, operating -30 ° to 85 °C, storage	0 ° to 70 °C, operating -30 ° to 85 °C, storage	0 ° to 70 °C, operating -30 ° to 85 °C, storage
Agency Approvals	UL, CE, CSA, RoHS, DFARS	UL, CE, CSA, RoHS, DFARS	CE, CSA, RoHS, DFARS	CE, RoHS, DFARS
Warranty	Lifetime	Lifetime	Lifetime	Lifetime

\* The power rating of the dry contact module must not exceed 10 VA under steady state or momentary in-rush conditions. For voltages at or below 20 volts, the current limit is 0.5 amps. For voltages above 20 volts, the maximum allowable current is determined by the following equation:  $10 \text{ VA} / \text{Voltage} = \text{Current maximum}$ . Rating curve is in the data sheet.



# SNAP Digital Output Modules

## Specifications—DC Modules (continued)

	SNAP-ODC5MA	SNAP-ODC5-i	SNAP-ODC5A-i	SNAP-ODC5ASNK
Key Feature	Diagnostic switches Four isolated channels	Four isolated channels	Four isolated channels	Load sinking
<b>Field Side Ratings (each channel)</b>				
Line Voltage - Range	5–60 VDC	5–60 VDC	5–200 VDC	5–200 VDC
Line Voltage - Nominal	5–48 VDC	5–48 VDC	5–200 VDC	5–200 VDC
Current Rating 0 °C to 70 °C Ambient	2 amps per module 0.5 amps per channel	3 amps per module	3 amps per module	3 amps per module
Surge Current	1.5 amps peak for 1 second	5 amps peak for 1 second	5 amps peak for 1 second	5 amps peak for 1 second
Minimum Load	20 mA	20 mA	20 mA	20 mA
Output Voltage Drop	1.6 volts max. @ 0.75 amps	1.6 volts max. @ 0.75 amps	1.6 volts max. @ 0.75 amps	1.6 volts max. @ 0.75 amps
Off-state Leakage	1 mA @ 60 VDC	1 mA @ 60 VDC	1 mA @ 200 VDC	1 mA @ 200 VDC
Peak Blocking Voltage	60 VDC	60 VDC	200 VDC	200 VDC
Fuse (Common to all Channels)	Has four isolated channels. User must provide own fusing.	Has four isolated channels. User must provide own fusing.	Has four isolated channels. User must provide own fusing.	250 VAC - 4A 5x20 mm Fast-acting Bell Fuse Part No. BEL 5HF4 Opto 22 Part No. SNAP-4A
Channel-to-channel isolation	300 VAC (1500 V transient)	300 VAC (1500 V transient)	300 VAC (1500 V transient)	Not applicable
<b>Logic Side Ratings</b>				
Pickup Voltage	4 V @ 5.5 mA	4 V @ 5.5 mA	4 V @ 5.5 mA	4 V @ 5.5 mA
Dropout Voltage	1 VDC	1 VDC	1 VDC	1 VDC
Control Resistance	220 ohms	220 ohms	220 ohms	220 ohms
Logic Supply Voltage	5 VDC ± 0.25 VDC	5 VDC ± 0.25 VDC	5 VDC ± 0.25 VDC	5 VDC ± 0.25 VDC
Logic Supply Current	50 mA maximum	50 mA maximum	50 mA maximum	50 mA maximum
<b>Module Ratings</b>				
Number of Channels Per Module	4	4	4	4
Turn-on Time	100 usec	100 usec	100 usec	100 usec
Turn-off Time	750 usec	750 usec	750 usec	750 usec
Isolation (Field Side to Logic Side)	4,000 volts (transient)	4,000 volts (transient)	4,000 volts (transient)	4,000 volts (transient)
Temperature	0 ° to 70 °C, operating -30 ° to 85 °C, storage	0 ° to 70 °C, operating -30 ° to 85 °C, storage	0 ° to 70 °C, operating -30 ° to 85 °C, storage	0 ° to 70 °C, operating -30 ° to 85 °C, storage
Agency Approvals	UL, CE, RoHS, DFARS	UL, CE, RoHS, DFARS	UL, CE, RoHS, DFARS	UL, CE, RoHS, DFARS
Warranty	30 months	Lifetime	Lifetime	Lifetime

# SNAP Digital Output Modules

## Specifications—DC Modules (continued)

	SNAP-ODC5SRCFM	SNAP-ODC5SNKFM	SNAP-ODC5RFM	SNAP-ODC5R5FM
Key Feature	Factory Mutual approved	Factory Mutual approved	Factory Mutual approved	Factory Mutual approved
<b>Field Side Ratings (each channel)</b>				
Line Voltage - Range	5–60 VDC	5–60 VDC	0–100 VDC 0–130 VAC*	0–100 VDC 0–130 VAC*
Line Voltage - Nominal	5–48 VDC	5–48 VDC	--	--
Current Rating 0°C to 70°C Ambient	3 amps per module	3 amps per module	0.5 amps switching*	0.5 amps switching*
Surge Current	5 amps peak for 1 second	5 amps peak for 1 second	0.5 amps*	0.5 amps*
Minimum Load	20 mA	20 mA	0 mA	0 mA
Output Voltage Drop	1.6 volts max. @ 0.75 amps	1.6 volts max. @ 0.75 amps	0 volts	0 volts
Off-state Leakage	1 mA @ 60 VDC	1 mA @ 60 VDC	0 mA	0 mA
Peak Blocking Voltage	60 VDC	60 VDC	100 VDC / 130 VAC	100 VDC / 130 VAC
Fuse (Common to all Channels)	250 VAC - 4A 5x20 mm Fast-acting Bell Fuse Part No. BEL 5HF4 Opto 22 Part SNAP-4A	250 VAC - 4A 5x20 mm Fast-acting Bell Fuse Part No. BEL 5HF4 Opto 22 Part SNAP-4A	Has four isolated channels. User must provide own fusing.	Has four isolated channels. User must provide own fusing.
<b>Logic Side Ratings</b>				
Pickup Voltage	4 V @ 5.5 mA	4 V @ 5.5 mA	4 V @ 5.5 mA	4 V @ 5.5 mA
Dropout Voltage	1 VDC	1 VDC	1 VDC	1 VDC
Control Resistance	220 ohms	220 ohms	220 ohms	220 ohms
Logic Supply Voltage	5 VDC ± 0.25 VDC	5 VDC ± 0.25 VDC	5 VDC ± 0.25 VDC	5 VDC ± 0.25 VDC
Logic Supply Current	50 mA maximum	50 mA maximum	50 mA maximum	50 mA maximum
<b>Module Ratings</b>				
Number of Channels Per Module	4	4	4	4
Turn-on Time	100 usec	100 usec	500 usec	500 usec
Turn-off Time	750 usec	750 usec	500 usec	500 usec
Isolation (Field Side to Logic Side)	4,000 volts (transient)	4,000 volts (transient)	1,500 volts (transient)	1,500 volts (transient)
Temperature	0 ° to 70 °C, operating -30 ° to 85 °C, storage	0 ° to 70 °C, operating -30 ° to 85 °C, storage	0 ° to 70 °C, operating -30 ° to 85 °C, storage	0 ° to 70 °C, operating -30 ° to 85 °C, storage
Agency Approvals	CE, FM, RoHS, DFARS	CE, FM, RoHS, DFARS	CE, FM, RoHS, DFARS	CE, FM, RoHS, DFARS
Warranty	Lifetime	Lifetime	30 months	30 months

\* The power rating of the dry contact module must not exceed 10 VA under steady state or momentary in-rush conditions. For voltages at or below 20 volts, the current limit is 0.5 amps. For voltages above 20 volts, the maximum allowable current is determined by the following equation: 10 VA / Voltage = Current maximum. Rating curve is in the data sheet.

# SNAP Digital Output Modules

## Specifications—DC Modules (continued)

	SNAP-ODC5-iFM	SNAP-ODC5A-iFM
Key Feature	Four isolated channels Factory Mutual approved	Four isolated channels Factory Mutual approved
<b>Field Side Ratings (each channel)</b>		
Line Voltage - Range	5–60 VDC	5–200 VDC
Line Voltage - Nominal	5–48 VDC	5–200 VDC
Current Rating 0°C to 70°C Ambient	3 amps per module	3 amps per module
Surge Current	5 amps peak for 1 second	5 amps peak for 1 second
Minimum Load	20 mA	20 mA
Output Voltage Drop	1.6 volts max. @ 0.75 amps	1.6 volts max. @ 0.75 amps
Off-state Leakage	1 mA @ 60 VDC	1 mA @ 60 VDC
Peak Blocking Voltage	60 VDC	200 VDC
Fuse (Common to all Channels)	Has four isolated channels. User must provide own fusing.	Has four isolated channels. User must provide own fusing.
<b>Logic Side Ratings</b>		
Pickup Voltage	4 V @ 5.5 mA	4 V @ 5.5 mA
Dropout Voltage	1 VDC	1 VDC
Control Resistance	220 ohms	220 ohms
Logic Supply Voltage	5 VDC ± 0.25 VDC	5 VDC ± 0.25 VDC
Logic Supply Current	50 mA maximum	50 mA maximum
<b>Module Ratings</b>		
Number of Channels Per Module	4	4
Turn-on Time	100 usec	100 usec
Turn-off Time	750 usec	750 usec
Isolation (Field Side to Logic Side)	4,000 volts (transient)	4,000 volts (transient)
Temperature	0 ° to 70 °C, operating -30 ° to 85 °C, storage	0 ° to 70 °C, operating -30 ° to 85 °C, storage
Agency Approvals	CE, FM, RoHS, DFARS	CE, FM, RoHS, DFARS
Warranty	Lifetime	Lifetime

# SNAP Digital Output Modules

## Schematics

### SNAP-ODC5SRC Output Module—Sourcing

Part Number	Description
SNAP-ODC5SRC	4-channel DC output 5–60 VDC logic source
SNAP-ODC5SRCFM	4-channel DC output 5–60 VDC logic source, Factory Mutual approved

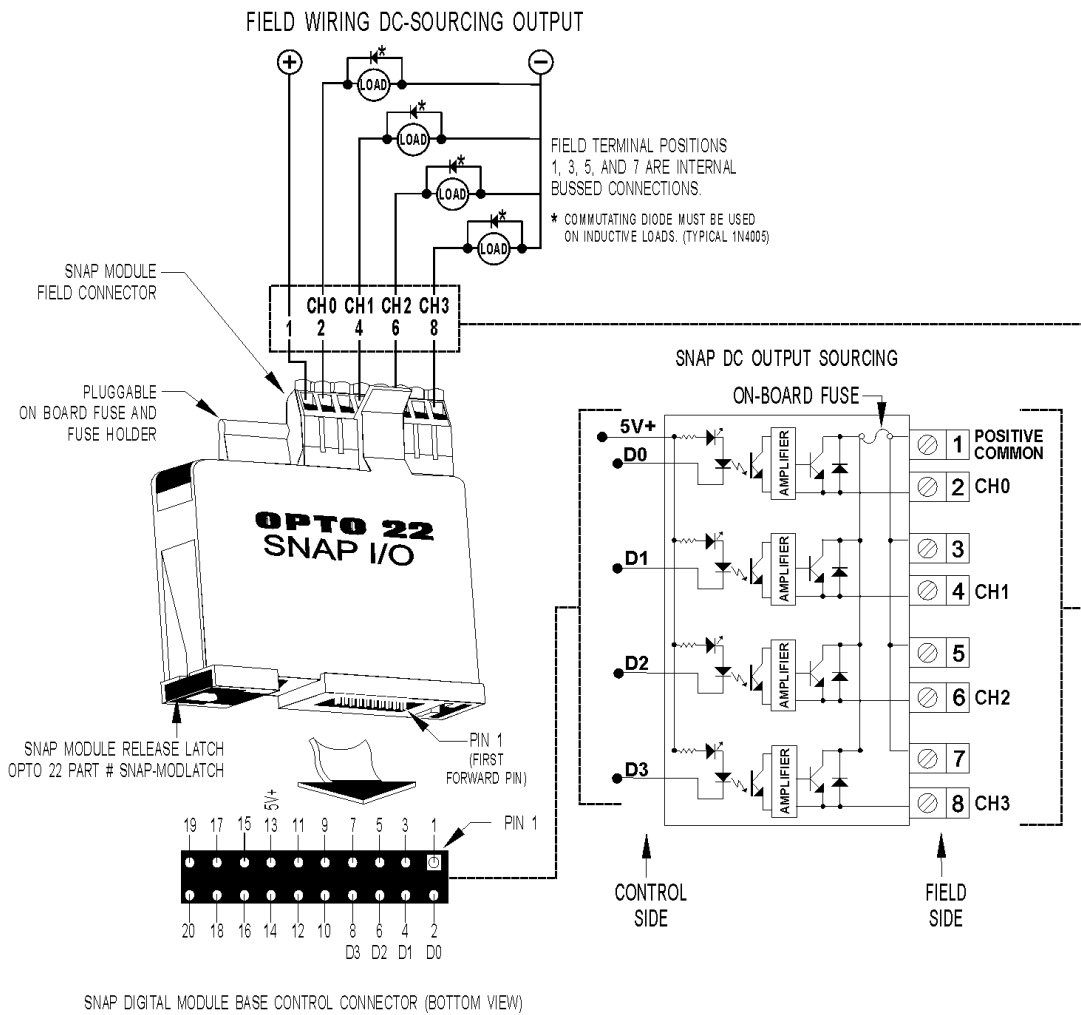

# SNAP Digital Output Modules

## Schematics

### SNAP-ODC5SNK and SNAP-ODC5ASNK Output Modules—Sinking

Part Number	Description
SNAP-ODC5SNK	4-channel DC output 5–60 VDC logic sink
SNAP-ODC5SNKFM	4-channel DC output 5–60 VDC logic sink, Factory Mutual approved
SNAP-ODC5ASNK	4-channel DC output 5–200 VDC logic sink

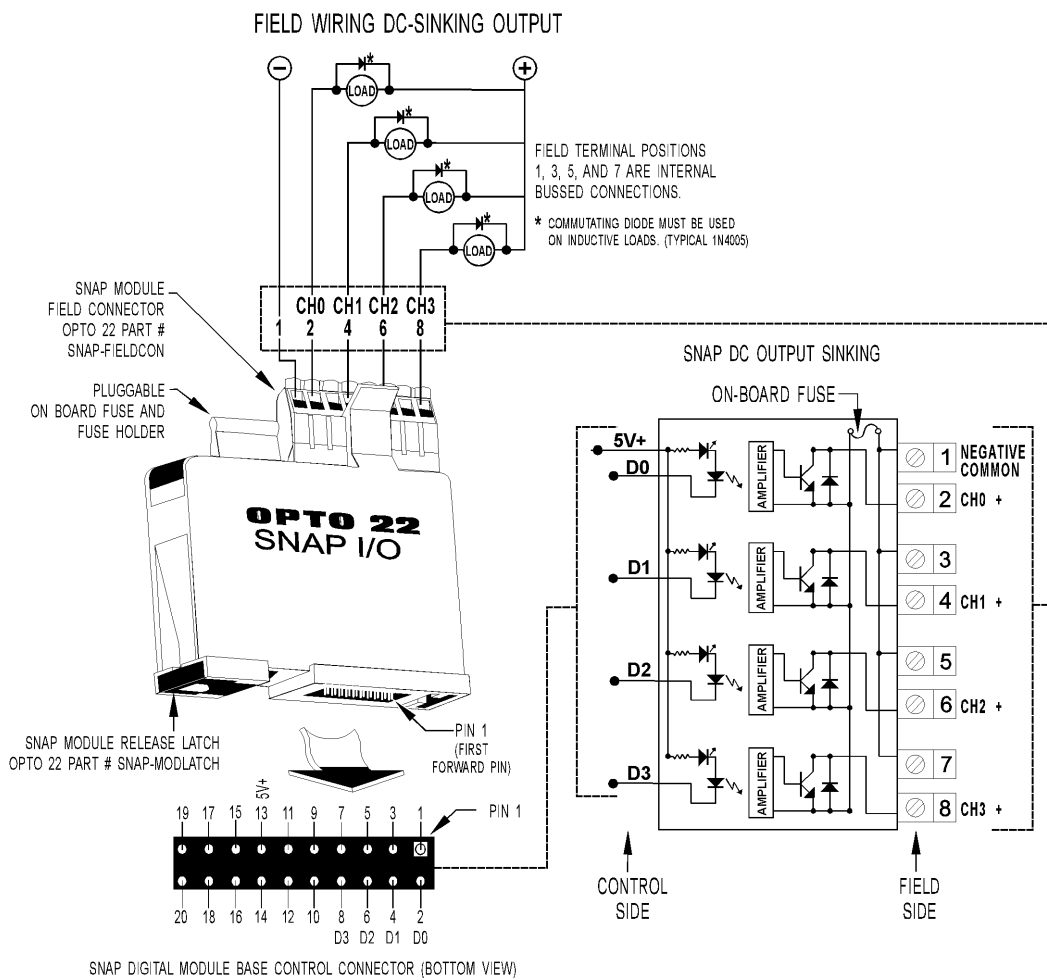

# SNAP Digital Output Modules

## Schematics

### SNAP-ODC5R and SNAP-ODC5R5 Dry Contact Module

Current Limit at Key Voltages	
VDC	mA
5	500
12	500
24	416
48	206
100 <sup>1</sup>	100

<sup>1</sup> Maximum DC voltage is 100 VDC.

NOTE: Commutating diode\* must be used on inductive loads. Typical wiring examples:

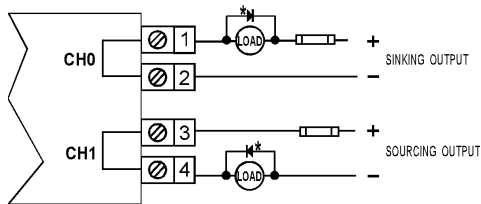

FIELD WIRING DRY CONTACT OUTPUT

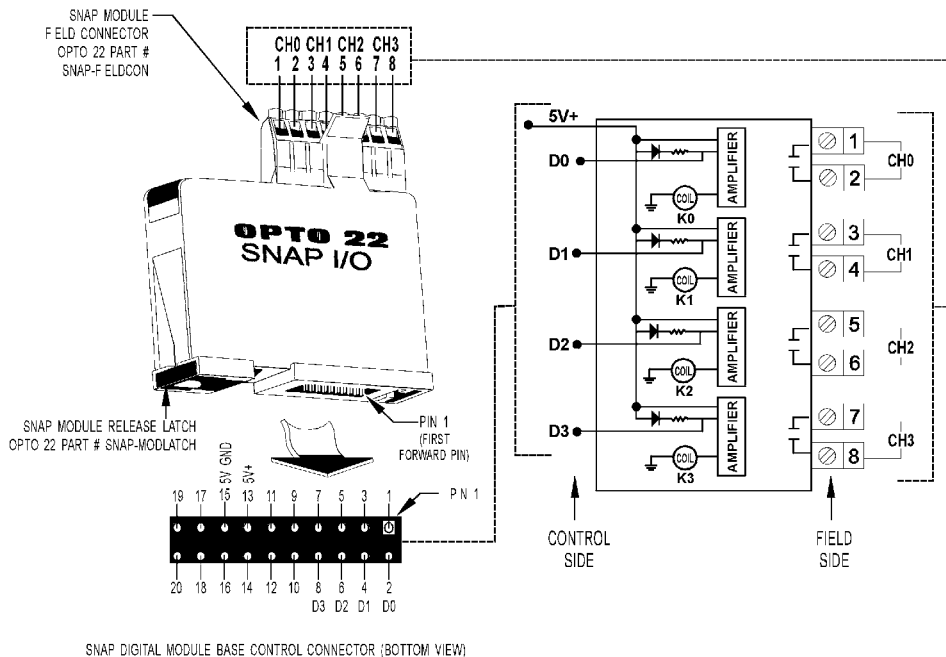

Part Number	Description
SNAP-ODC5R	4-channel dry contact output, normally open
SNAP-ODC5R5	4-channel dry contact output, normally closed
SNAP-ODC5RFM	4-channel dry contact output, normally open, Factory Mutual approved
SNAP-ODC5R5FM	4-channel dry contact output, normally closed, Factory Mutual approved

10 VA Rating for Reed Relay (Dry Contact) Modules

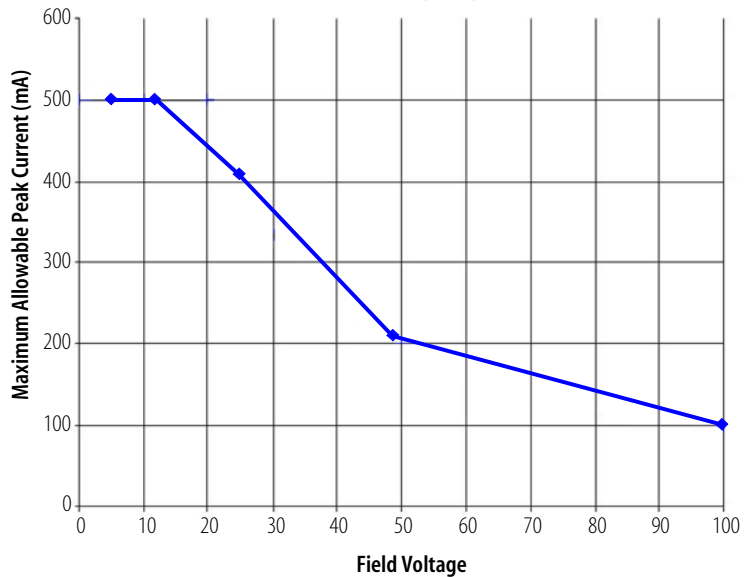

# SNAP Digital Output Modules

## Schematics

### SNAP-ODC5MA Output Module with Manual/Auto Switches

Part Number	Description
SNAP-ODC5MA	4-channel isolated DC output 5–60 VDC, 5 VDC logic, with manual/auto switches

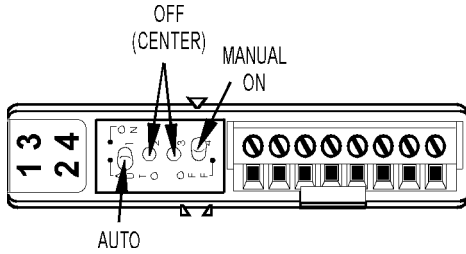

#### TYPICAL WIRING EXAMPLES

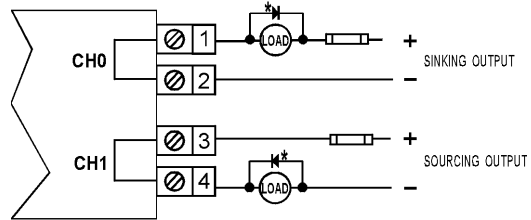

\* COMMUTATING DIODE MUST BE USED ON INDUCTIVE LOADS. (TYPICAL 1N4005)

#### FIELD WIRING DC OUTPUT

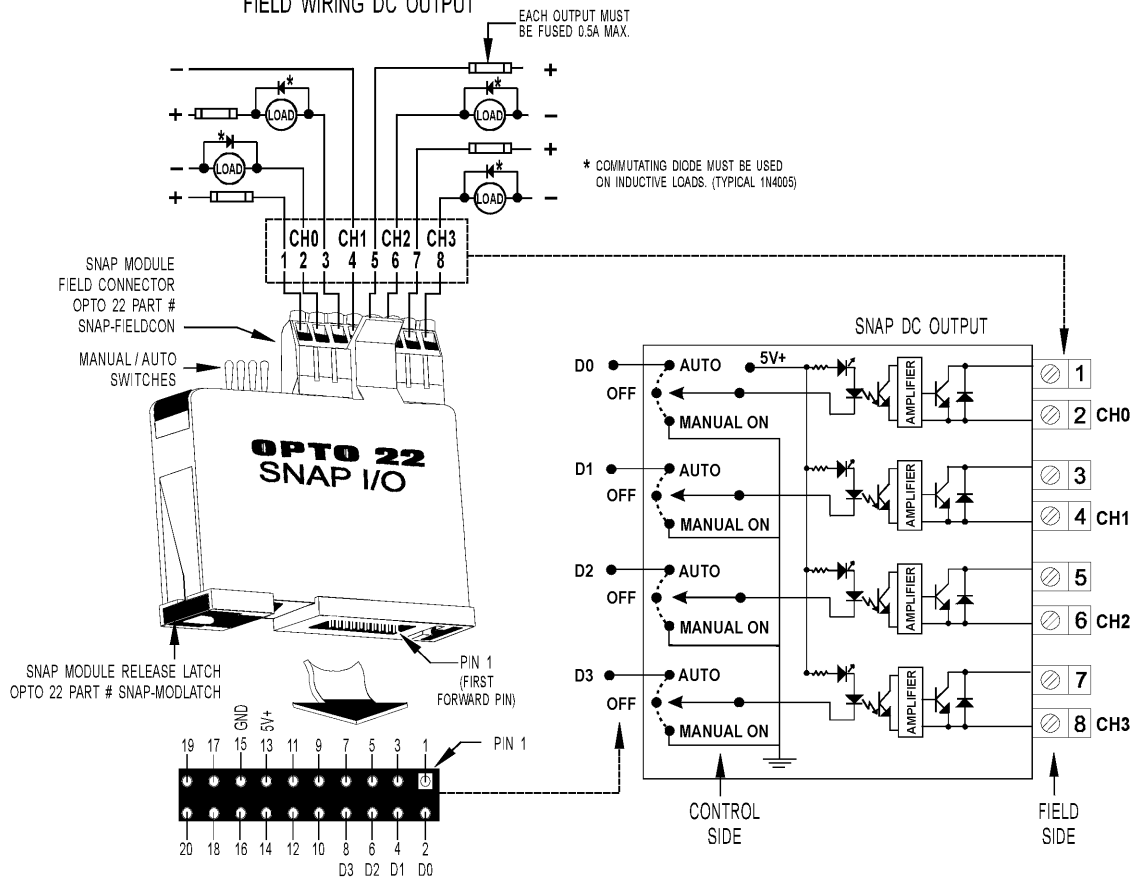

SNAP DIGITAL MODULE BASE CONTROL CONNECTOR (BOTTOM VIEW)

# SNAP Digital Output Modules

## Schematics

### SNAP-ODC5-i and SNAP-ODC5A-i Isolated Output Module

Part Number	Description
SNAP-ODC5-i	4-channel isolated DC output 5–60 VDC, 5 VDC logic
SNAP-ODC5A-i	4-channel isolated DC output 5–200 VDC, 5 VDC logic
SNAP-ODC5-iFM	4-channel isolated DC output 5–60 VDC, 5 VDC logic, Factory Mutual approved
SNAP-ODC5A-iFM	4-channel isolated DC output 5–200 VDC, 5 VDC logic, Factory Mutual approved

#### TYPICAL WIRING EXAMPLES

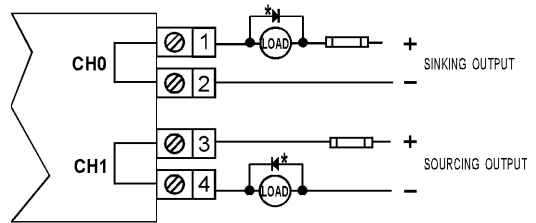

\* COMMUTATING DIODE MUST BE USED ON INDUCTIVE LOADS. (TYPICAL 1N4005)

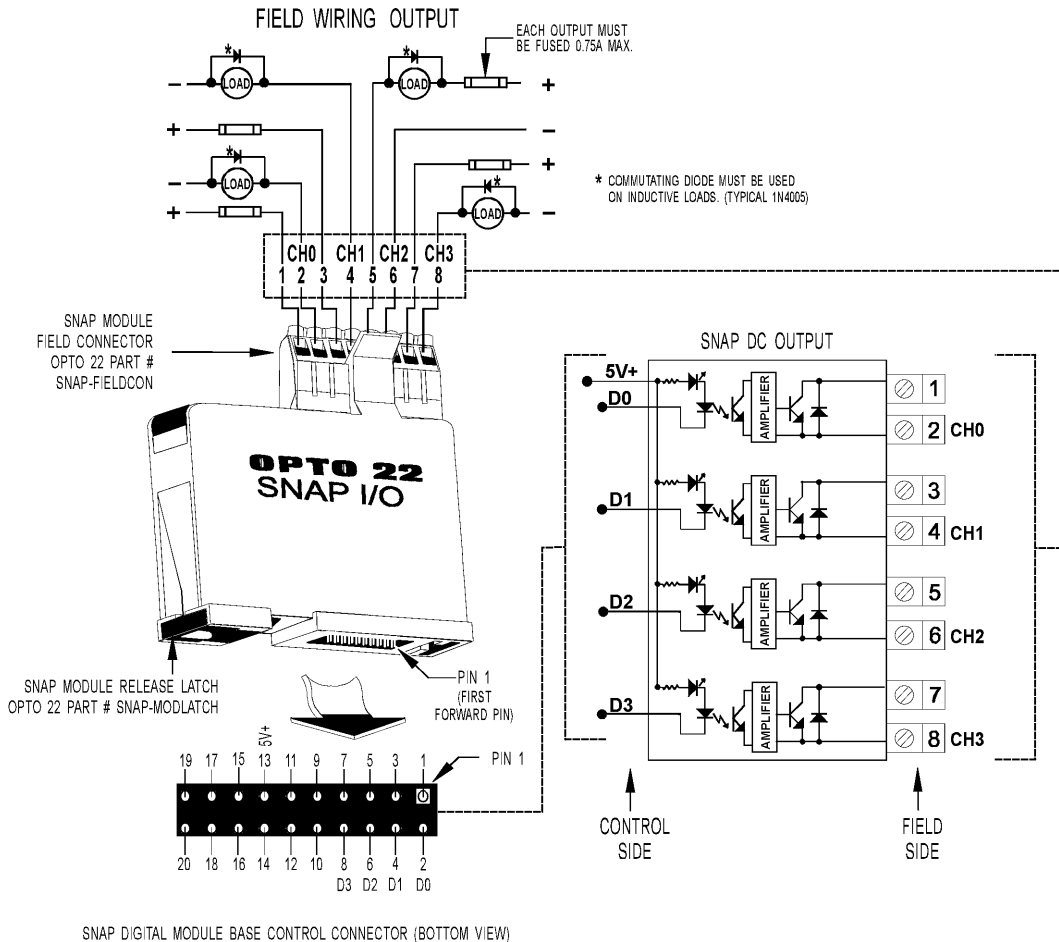



# SNAP Digital Output Modules

## Dimensional Drawing

All Models Except MA

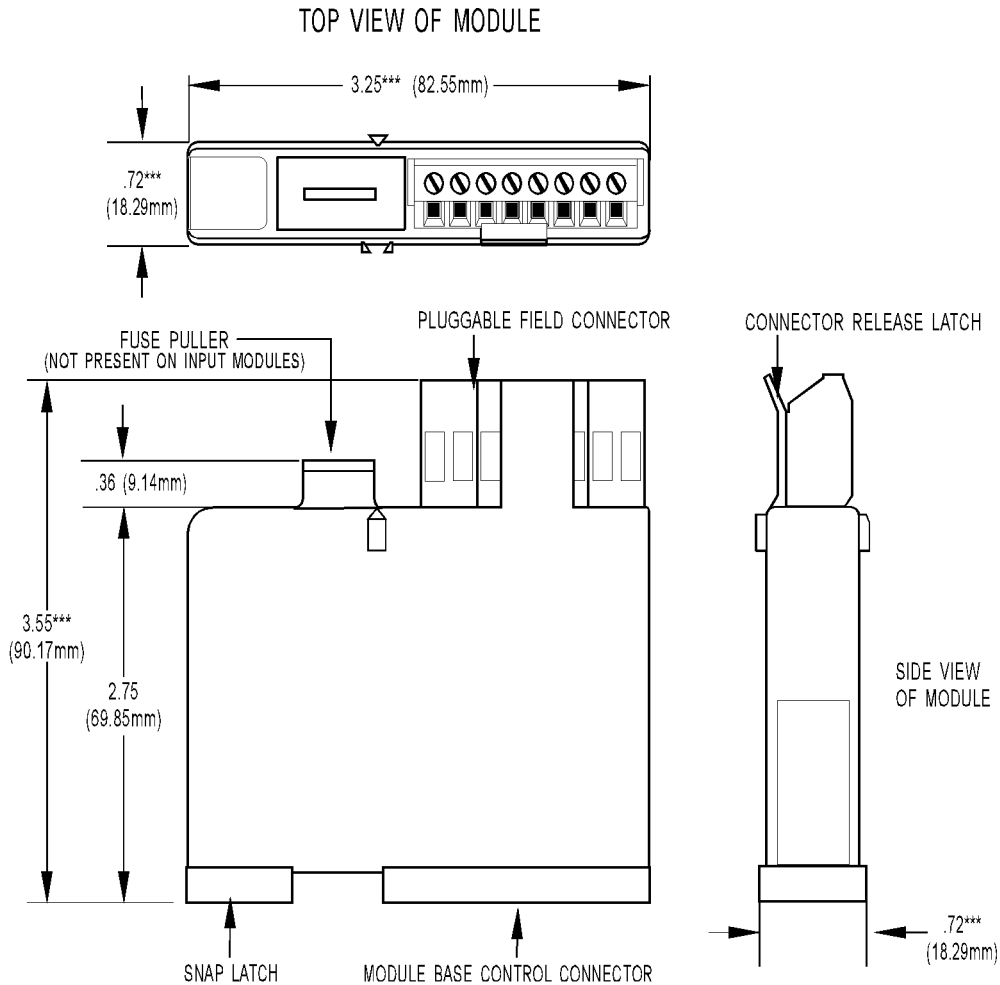

### TOLERANCES LEGEND

\* +/- .010"      \*\* +/- .020"  
 \*\*\* +/- .030"    \*\*\*\* +/- .060"  
 NO \* REFERENCE ONLY

# SNAP Digital Output Modules

## Dimensional Drawing

All MA Models

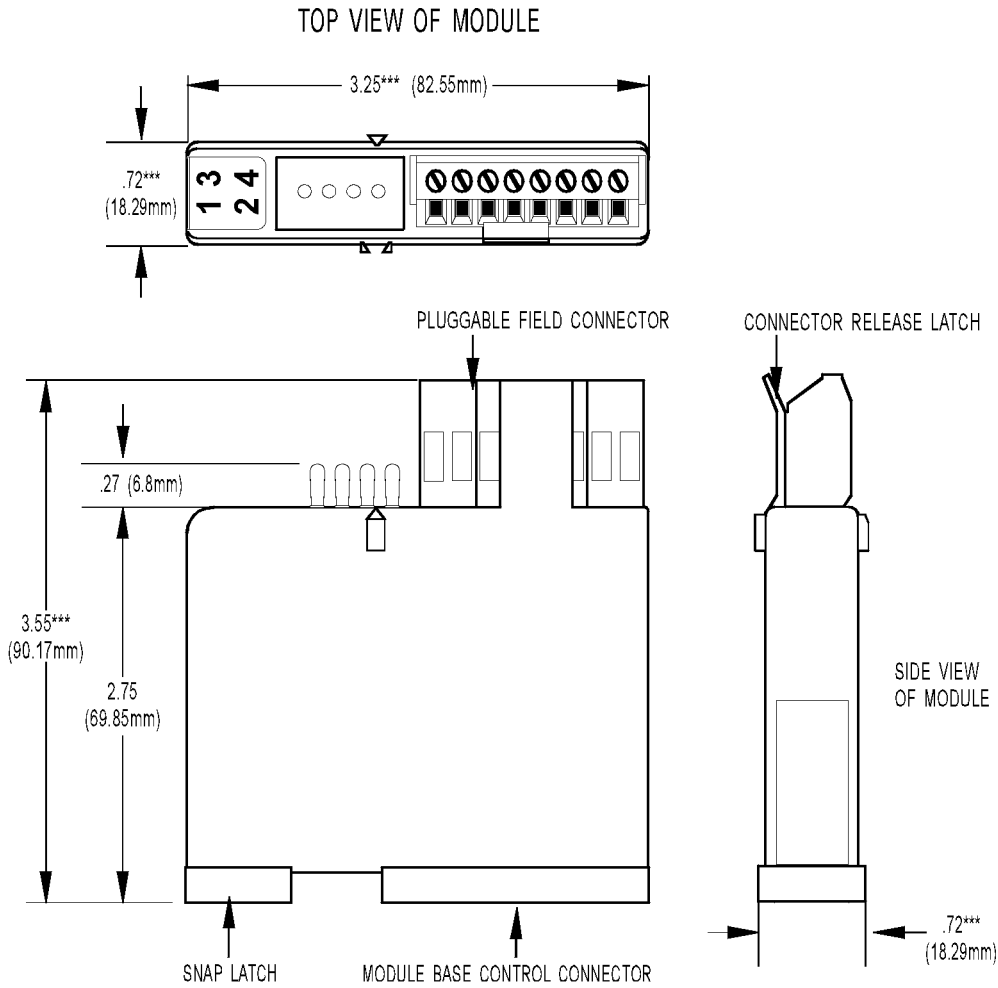

**TOLERANCES LEGEND**  
 \* +/- .010"      \*\* +/- .020"  
 \*\*\* +/- .030"    \*\*\*\* +/- .060"  
 NO \* REFERENCE ONLY

# SNAP Digital Output Modules

## Dimensional Drawing

All Models

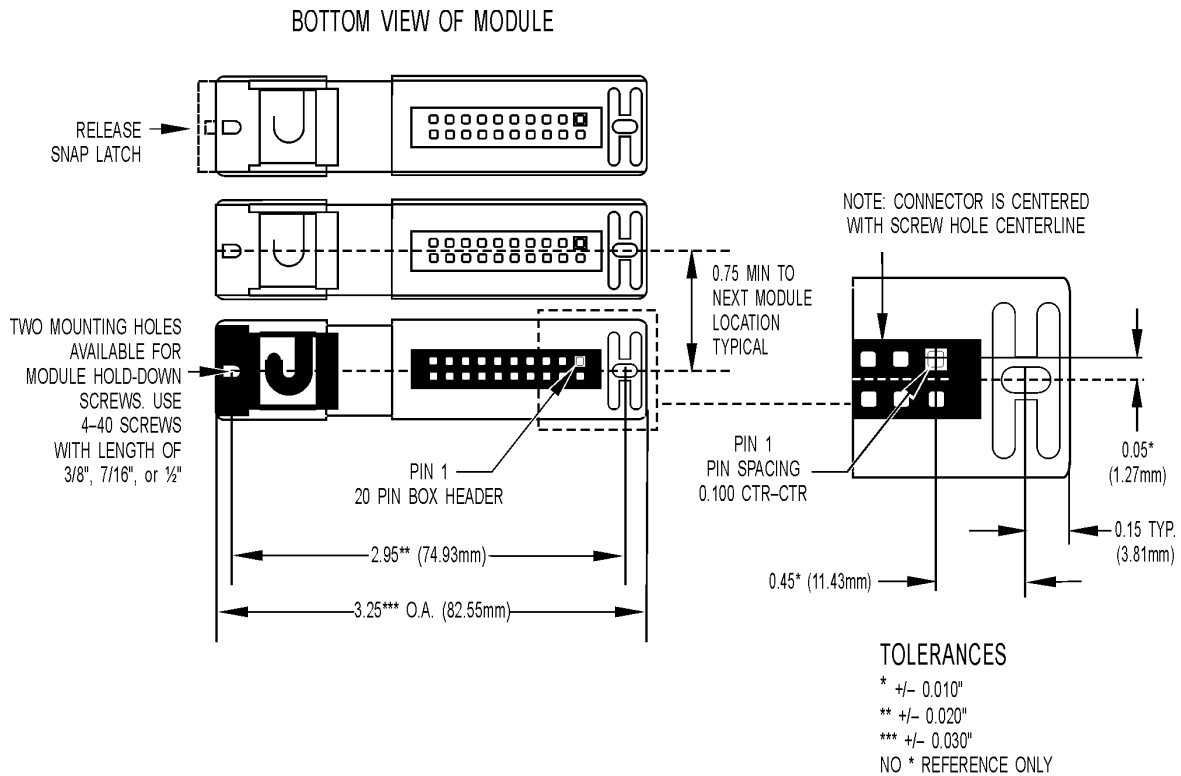

**IMPORTANT:** The mounting rack connector has 24 pins; the module connector has 20 pins. The extra pins on the mounting rack connector prevent misalignment of the module during installation.

# SNAP Digital Output Modules

## Dimensional Drawing

All Models

**SNAP Digital Module Mounted on SNAP Rack**

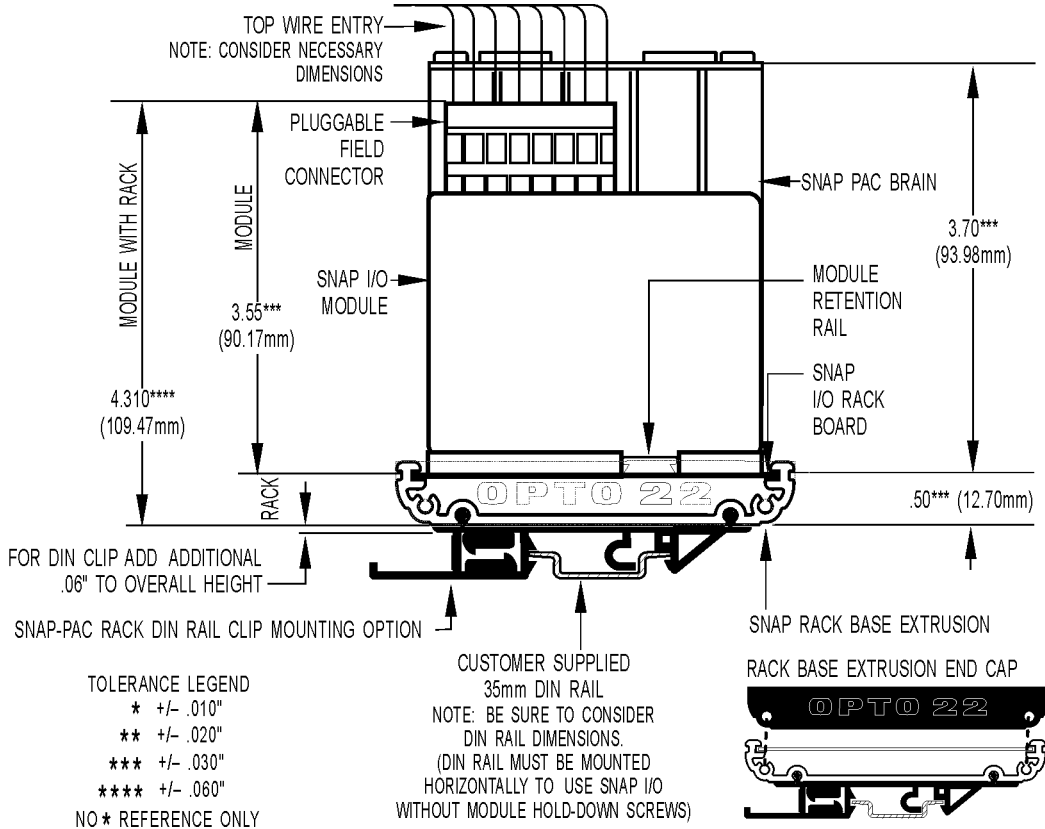

# More About Opto 22

## Products

Opto 22 develops and manufactures reliable, flexible, easy-to-use hardware and software products for industrial automation, remote monitoring, and data acquisition applications.

### SNAP PAC System

Designed to simplify the typically complex process of understanding, selecting, buying, and applying an automation system, the SNAP PAC System consists of four integrated components:

- SNAP PAC controllers
- PAC Project™ Software Suite
- SNAP PAC brains
- SNAP I/O™

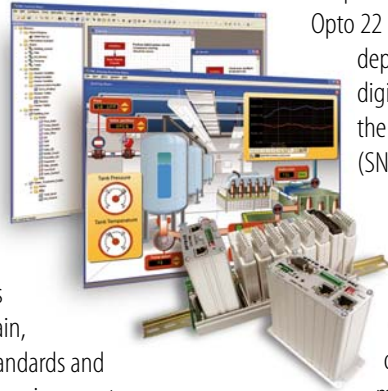

### SNAP PAC Controllers

Programmable automation controllers (PACs) are multifunctional, multidomain, modular controllers based on open standards and providing an integrated development environment.

Opto 22 has been manufacturing PACs for many years. The latest models include the standalone SNAP PAC S-series and the rack-mounted SNAP PAC R-series. Both handle a wide range of digital, analog, and serial functions and are equally suited to data collection, remote monitoring, process control, and discrete and hybrid manufacturing.

SNAP PACs are based on open Ethernet and Internet Protocol (IP) standards, so you can build or extend a system without the expense and limitations of proprietary networks and protocols.

### PAC Project Software Suite

Opto 22's PAC Project Software Suite provides full-featured and cost-effective control programming, HMI (human machine interface) development and runtime, OPC server, and database connectivity software to power your SNAP PAC System.

These fully integrated software applications share a single tagname database, so the data points you configure in PAC Control™ are immediately available for use in PAC Display™, OptoOPCServer™, and OptoDataLink™. Commands are in plain English; variables and I/O point names are fully descriptive.

PAC Project Basic offers control and HMI tools and is free for download on our website, [www.opto22.com](http://www.opto22.com). PAC Project Professional, available for separate purchase, adds OptoOPCServer, OptoDataLink, options for Ethernet link redundancy or segmented networking, and support for legacy Opto 22 serial *mistic*™ I/O units.

### SNAP PAC Brains

While SNAP PAC controllers provide central control and data distribution, SNAP PAC brains provide distributed intelligence for I/O processing and communications. Brains offer analog, digital, and serial functions, including thermocouple linearization; PID loop control; and optional high-speed digital counting (up to 20 kHz), quadrature counting, TPO, and pulse generation and measurement.

### SNAP I/O

I/O provides the local connection to sensors and equipment. Opto 22 SNAP I/O offers 1 to 32 points of reliable I/O per module, depending on the type of module and your needs. Analog, digital, serial, and special-purpose modules are all mixed on the same mounting rack and controlled by the same processor (SNAP PAC brain or rack-mounted controller).

## Quality

Founded in 1974 and with over 85 million devices sold, Opto 22 has established a worldwide reputation for high-quality products. All are made in the U.S.A. at our manufacturing facility in Temecula, California. Because we do no statistical testing and each part is tested twice before leaving our factory, we can guarantee most solid-state relays and optically isolated I/O modules for life.

## Free Product Support

Opto 22's Product Support Group offers free, comprehensive technical support for Opto 22 products. Our staff of support engineers represents decades of training and experience. Product support is available in English and Spanish, by phone or email, Monday through Friday, 7 a.m. to 5 p.m. PST.

## Free Customer Training

Hands-on training classes for the SNAP PAC System are offered at our headquarters in Temecula, California. Each student has his or her own learning station; classes are limited to nine students. Registration for the free training class is on a first-come, first-served basis. See our website, [www.opto22.com](http://www.opto22.com), for more information or email [training@opto22.com](mailto:training@opto22.com).

## Purchasing Opto 22 Products

Opto 22 products are sold directly and through a worldwide network of distributors, partners, and system integrators. For more information, contact Opto 22 headquarters at 800-321-6786 or 951-695-3000, or visit our website at [www.opto22.com](http://www.opto22.com).

[www.opto22.com](http://www.opto22.com)