

301CNQ... SERIES

SCHOTTKY RECTIFIER

300 Amp

Major Ratings and Characteristics

Characteristics	301CNQ...	Units
$I_{F(AV)}$ Rectangular waveform	300	A
V_{RRM} range	35 to 45	V
I_{FSM} @ tp = 5 μ s sine	16,000	A
V_F @ 80 Apk, $T_J = 125^\circ\text{C}$ (per leg)	0.59	V
T_J range	-55 to 175	$^\circ\text{C}$

Description/Features

The 301CNQ center tap Schottky rectifier module series has been optimized for low reverse leakage at high temperature. The proprietary barrier technology allows for reliable operation up to 175 $^\circ\text{C}$ junction temperature. Typical applications are in high current switching power supplies, converters, free-wheeling diodes, welding and reverse battery protection.

- 175 $^\circ\text{C}$ T_J operation
- Center tap module
- High purity, high temperature epoxy encapsulation for enhanced mechanical strength and moisture resistance
- Low forward voltage drop
- High frequency operation
- Guard ring for enhanced ruggedness and long term reliability

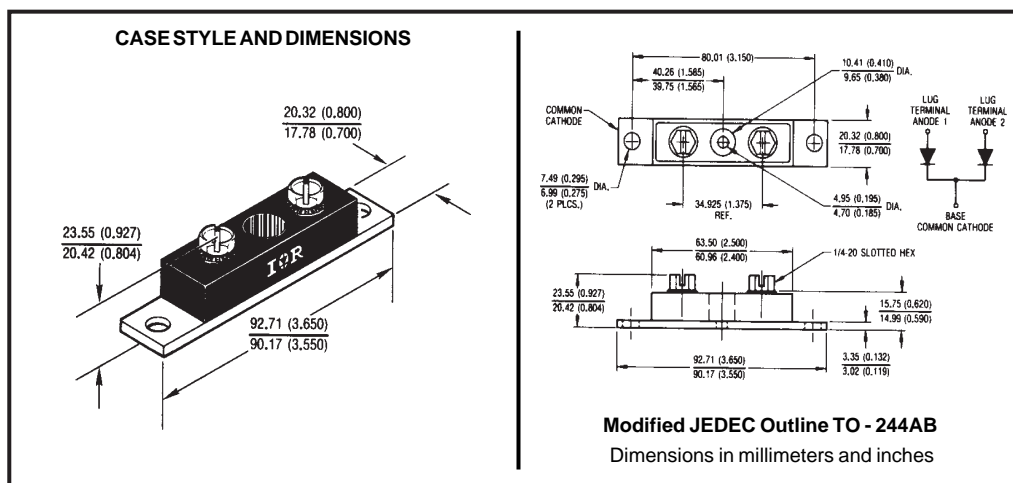

Voltage Ratings

Part number	301CNQ035	301CNQ040	301CNQ045
V_R Max. DC Reverse Voltage (V)	35	40	45
V_{RWM} Max. Working Peak Reverse Voltage (V)			

Absolute Maximum Ratings

Parameters	301CNQ	Units	Conditions
$I_{F(AV)}$ Max. Average Forward Current * See Fig. 5	300	A	50% duty cycle @ $T_C = 81^\circ\text{C}$, rectangular wave form
I_{FSM} Max. Peak One Cycle Non-Repetitive Surge Current (Per Leg) * See Fig. 7	16,000	A	5 μ s Sine or 3 μ s Rect. pulse Following any rated load condition and with rated V_{RWM} applied
	3200		
E_{AS} Non-Repetitive Avalanche Energy (Per Leg)	202	mJ	$T_J = 25^\circ\text{C}$, $I_{AS} = 40$ Amps, $L = 0.34$ mH
I_{AR} Repetitive Avalanche Current (Per Leg)	30	A	Current decaying linearly to zero in 1 μ sec Frequency limited by T_J max. $V_A = 1.5 \times V_R$ typical

Electrical Specifications

Parameters	301CNQ	Units	Conditions
V_{FM} Max. Forward Voltage Drop (Per Leg) * See Fig. 1 (1)	0.69	V	@ 150A $T_J = 25^\circ\text{C}$
	0.90	V	@ 300A
	0.59	V	@ 150A $T_J = 100^\circ\text{C}$
	0.76	V	@ 300A
I_{RM} Max. Reverse Leakage Current (Per Leg) * See Fig. 2 (1)	10	mA	$T_J = 25^\circ\text{C}$ $V_R = \text{rated } V_R$
	90	mA	$T_J = 125^\circ\text{C}$
C_T Max. Junction Capacitance (Per Leg)	5200	pF	$V_R = 5V_{DC}$, (test signal range 100Khz to 1Mhz) 25°C
L_S Typical Series Inductance (Per Leg)	7.0	nH	From top of terminal hole to mounting plane
dv/dt Max. Voltage Rate of Change (Rated V_R)	10,000	V/ μ s	

(1) Pulse Width < 300 μ s, Duty Cycle < 2%

Thermal-Mechanical Specifications

Parameters	301CNQ	Units	Conditions
T_J Max. Junction Temperature Range	-55 to 175	$^\circ\text{C}$	
T_{stg} Max. Storage Temperature Range	-55 to 175	$^\circ\text{C}$	
R_{thJC} Max. Thermal Resistance Junction to Case (Per Leg)	0.40	$^\circ\text{C/W}$	DC operation * See Fig. 4
R_{thJC} Max. Thermal Resistance Junction to Case (Per Package)	0.20	$^\circ\text{C/W}$	DC operation
R_{thCS} Typical Thermal Resistance, Case to Heatsink	0.10	$^\circ\text{C/W}$	Mounting surface, smooth and greased
wt Approximate Weight	79(2.80)	g(oz.)	
T Mounting Torque Base	Min.	40(35)	Kg-cm (lbf-in)
	Max.	58(50)	
	Typ.	17(15)	
	Terminal Torque	Min.	
	Max.	86(75)	
Case Style	TO - 244AB		Modified JEDEC

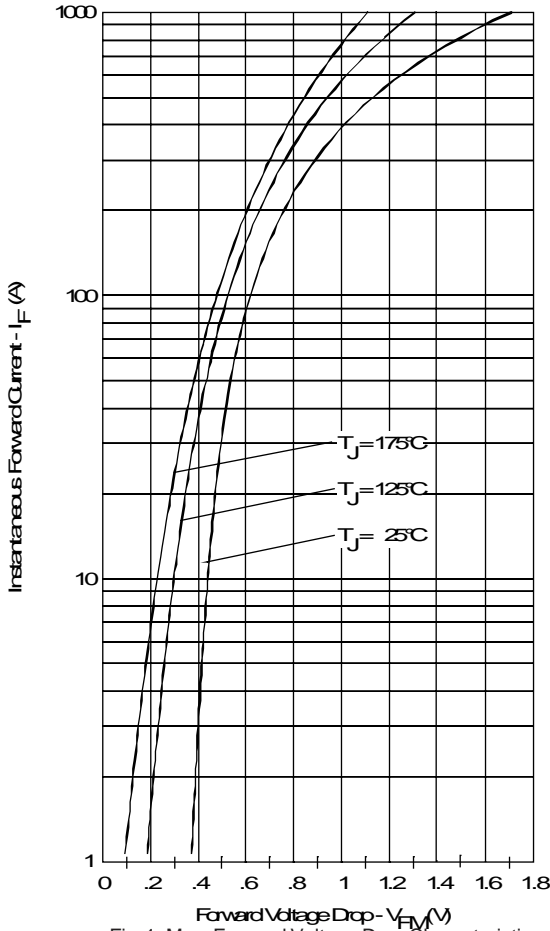

Fig. 1 - Max. Forward Voltage Drop Characteristics (Per Leg)

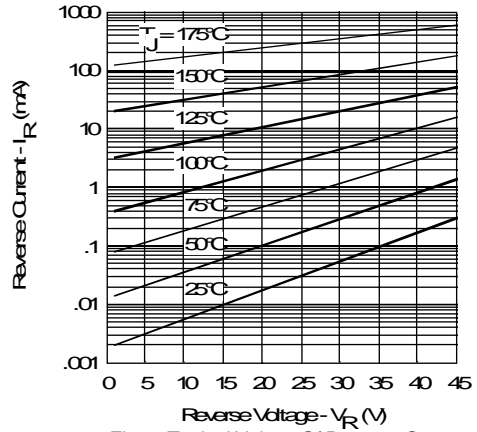

Fig. 2 - Typical Values Of Reverse Current Vs. Reverse Voltage (Per Leg)

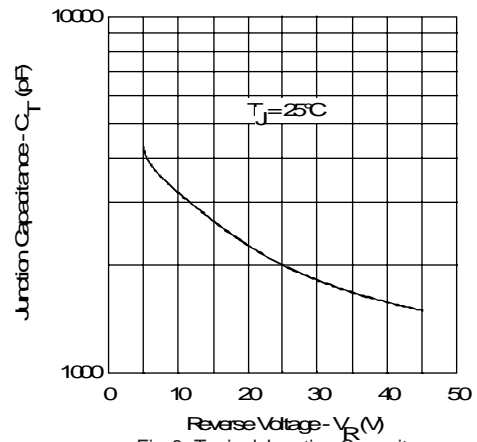

Fig. 3 - Typical Junction Capacitance Vs. Reverse Voltage (Per Leg)

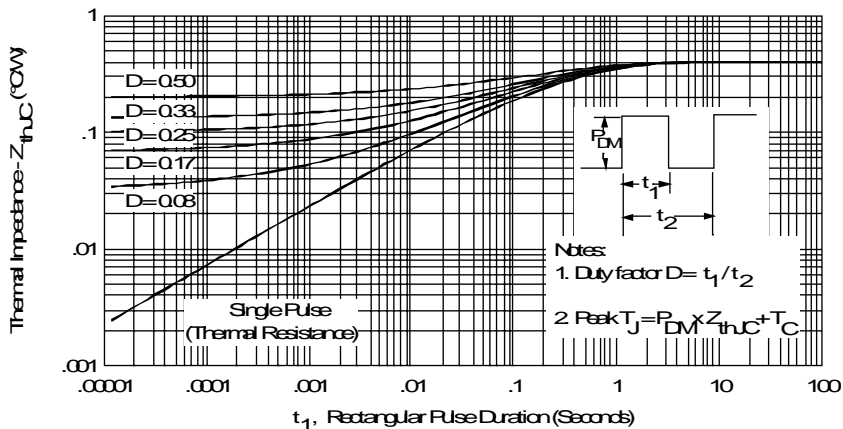

Fig. 4 - Max. Thermal Impedance Z_{thJC} Characteristics (Per Leg)

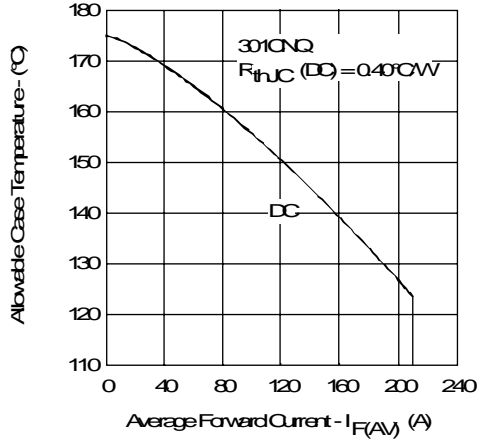

Fig. 5- Max. Allowable Case Temperature Vs. Average Forward Current (Per Leg)

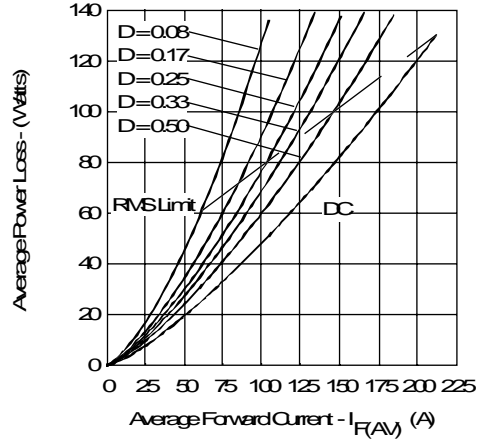

Fig. 6- Forward Power Loss Characteristics (Per Leg)

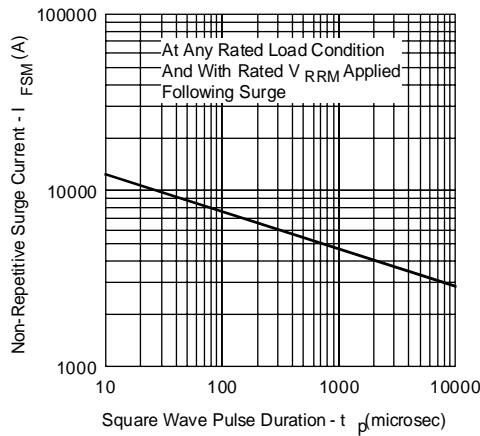

Fig. 7- Max. Non-Repetitive Surge Current (Per Leg)

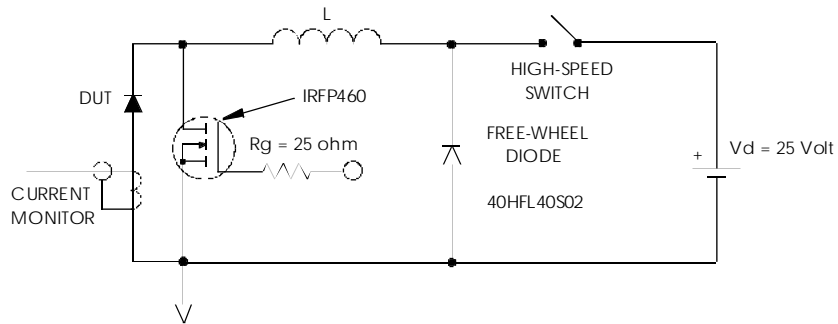

Fig. 8- Unclamped Inductive Test Circuit