



Data and signal line chokes

Common-mode chokes, ring core
0.005 ... 47 mH, 100 ... 2000 mA, 60 °C

Series/Type: **B82793C0/S0**

Date: April 2008

SMD

Rated voltage 42 V AC/80 V DC
Rated inductance 0.005 mH to 47 mH
Rated current 100 mA to 2000 mA

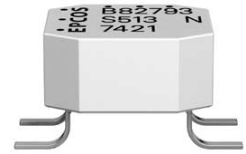
Construction

- Current-compensated double choke
- Ferrite core
- LCP case (UL 94 V-0), silicone potting
- Bifilar winding (B82793C0/K0)
- Sector winding (B82793S0/L0)

Features

- High rated currents, reduced components height
- Qualified to AEC-Q200 ($L \leq 4.7$ mH)
- Suitable for reflow soldering
- RoHS-compatible

Function

- B82793C0/K0:
Suppression of asymmetrical interference coupled in on lines, whereas data signals up to some MHz can pass unaffectedly.
- B82793S0/L0:
Suppression of asymmetrical and symmetrical interference (by L_{stray}) coupled in on lines. The high-frequency portions of the symmetrical data signal are decreased so far that EMC problems can be significantly reduced.

Applications

- Automotive applications, e.g. CAN bus
- Industrial applications
- Types with $L_R > 4.7$ mH only for telecom applications

Terminals

- Base material CuSn6
- Layer composition Ni, Sn
- Hot-dipped

Marking

- Marking on component: Manufacturer, process location (coded), winding method (coded), ordering code (short form), date of manufacture (YMMD)
- Minimum data on reel: Manufacturer, ordering code, L value and tolerance, quantity, date of packing

Delivery mode and packing unit

- 16-mm blister tape, wound on 330-mm \varnothing reel
- Packing unit: 1500 pcs./reel

SMD

Dimensional drawing and pin configuration

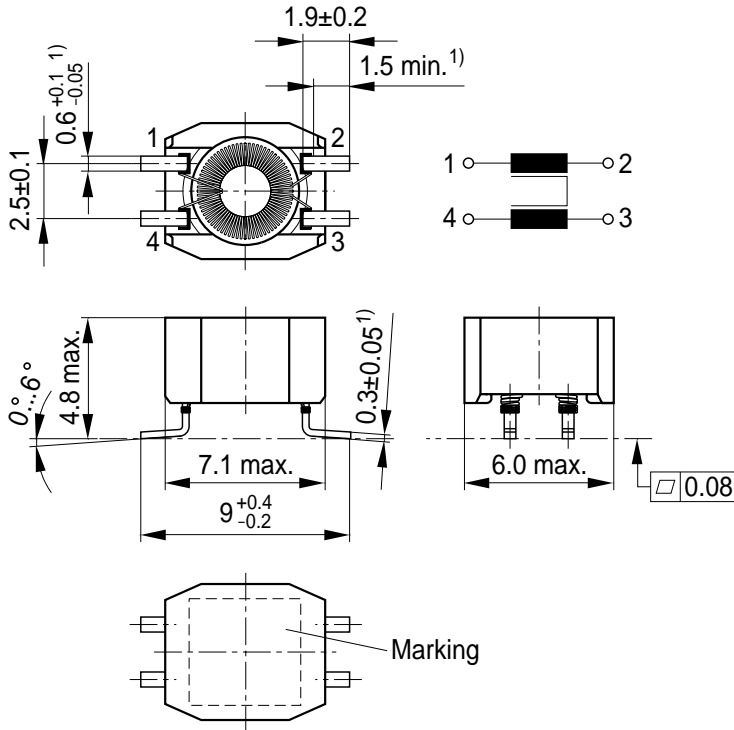

Layout recommendation

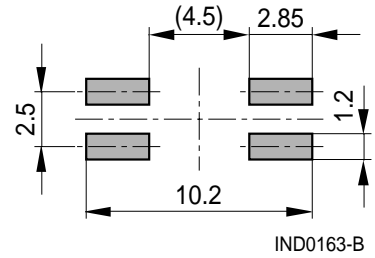

1) Soldering area

IND0010-9-E

Dimensions in mm

Taping and packing

Blister tape

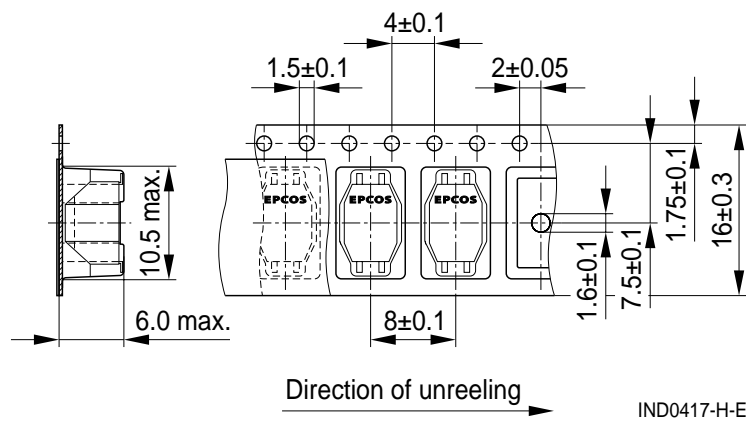

Reel

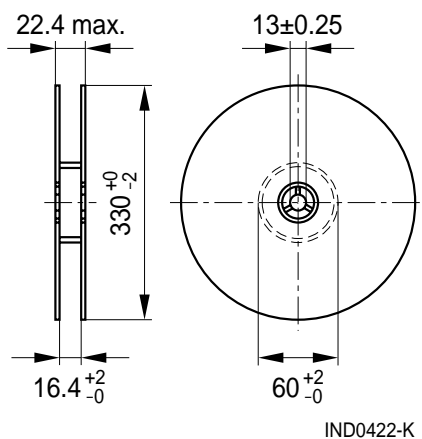

Dimensions in mm

Technical data and measuring conditions

| | |
|---|--|
| Rated voltage V_R | 42 V AC (50/60 Hz) / 80 V DC |
| Rated temperature T_R | 60 °C |
| Rated current I_R | Referred to 50 Hz and rated temperature |
| Rated inductance L_R | Measured with Agilent 4284A, 0.1 mA, 20 °C Measuring frequency: $L_R \leq 1$ mH = 100 kHz $L_R > 1$ mH = 10 kHz Inductance is specified per winding. |
| Inductance tolerance | $\pm 30\%$ ($L_R \leq 0.47$ mH), $-30/+50\%$ ($L_R \geq 1$ mH) at 20 °C |
| Inductance decrease $\Delta L/L$ | < 10% at DC magnetic bias with I_R , 20 °C |
| Stray inductance $L_{\text{stray,typ}}$ | Measured with Agilent 4284A, 5 mA, 20 °C, typical values Measuring frequency: $L_R \leq 11$ μ H = 1 MHz $L_R > 11$ μ H = 100 kHz |
| DC resistance R_{typ} | Measured at 20 °C, typical values, specified per winding |
| Solderability | SnPb: (215 \pm 3) °C, (3 \pm 0.3) s Sn96.5Ag3.0Cu0.5: (245 \pm 5) °C, (3 \pm 0.3) s Wetting of soldering area $\geq 95\%$ (to IEC 60068-2-58) |
| Resistance to soldering heat | (260 \pm 5) °C, (10 \pm 1) s (to IEC 60068-2-58) |
| Climatic category | 40/125/56 (to IEC 60068-1) |
| Storage conditions (packaged) | -25 °C ... +40 °C, $\leq 75\%$ RH |
| Weight | Approx. 0.25 g |

Characteristics and ordering codes

| L_R mH | $L_{\text{stray,typ}}$ nH | I_R mA | R_{typ} m Ω | V_{test} V DC, 2 s | Ordering code |
|-------------|------------------------------|-------------|--------------------------------|--------------------------------|-----------------|
| 0.005 | 40 | 1200 | 60 | 250 | B82793C0502N201 |
| 0.006 | 30 | 2000 | 20 | 250 | B82793K0602N201 |
| 0.006 | 250 | 2000 | 20 | 250 | B82793L0602N201 |
| 0.011 | 50 | 800 | 80 | 250 | B82793C0113N201 |
| 0.025 | 60 | 800 | 110 | 250 | B82793C0253N201 |
| 0.025 | 1400 | 800 | 110 | 250 | B82793S0253N201 |
| 0.051 | 70 | 800 | 140 | 250 | B82793C0513N201 |
| 0.051 | 2300 | 800 | 140 | 250 | B82793S0513N201 |
| 0.10 | 100 | 500 | 180 | 250 | B82793C0104N201 |
| 0.47 | 100 | 700 | 170 | 750 | B82793C0474N215 |
| 1.0 | 70 | 700 | 140 | 750 | B82793C0105N265 |
| 2.2 | 120 | 500 | 400 | 750 | B82793C0225N265 |
| 4.7 | 250 | 400 | 550 | 750 | B82793C0475N265 |

For telecommunications

| | | | | | |
|----|------|-----|------|-----|-----------------|
| 20 | 300 | 100 | 1800 | 750 | B82793C0206N265 |
| 47 | 1200 | 100 | 3700 | 750 | B82793C0476N265 |

Sample kit available. Ordering code: B82793X001.
For more information refer to chapter "Sample kits".

SMD

Insertion loss α (typical values at $|Z| = 50 \Omega$, 20°C)

———— asymmetrical, all branches in parallel (common mode)

- - - - - symmetrical (differential mode)

$L_R = 0.005 \text{ mH}$

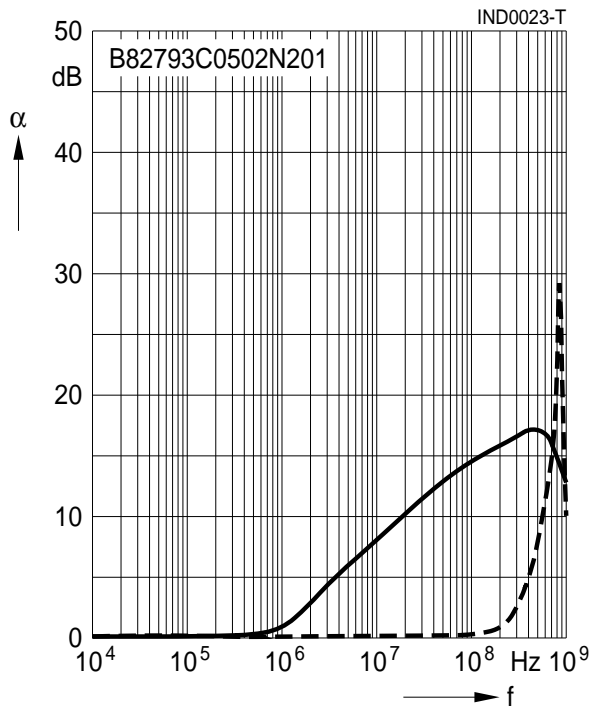

$L_R = 0.006 \text{ mH}$ (low L_{stray})

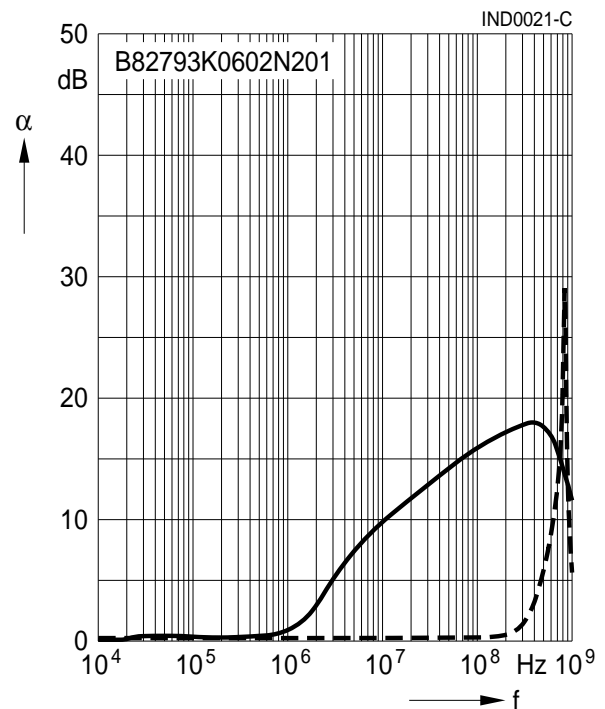

$L_R = 0.006 \text{ mH}$ (high L_{stray})

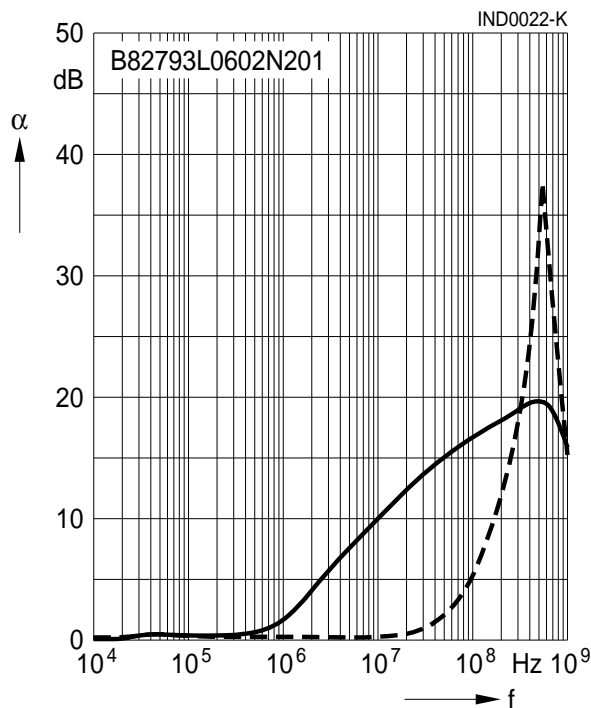

$L_R = 0.011 \text{ mH}$

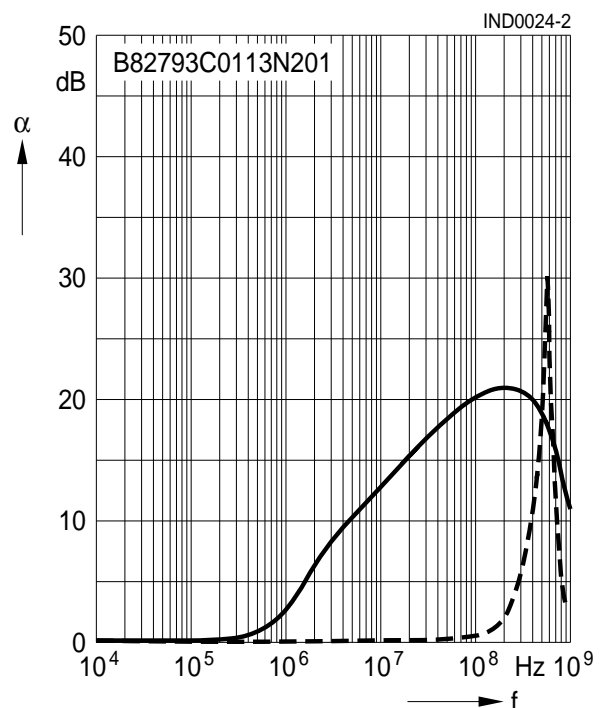

SMD

Insertion loss α (typical values at $|Z| = 50 \Omega$, 20°C)

———— asymmetrical, all branches in parallel (common mode)

- - - - - symmetrical (differential mode)

$L_R = 0.025 \text{ mH}$ (low L_{stray})

$L_R = 0.025 \text{ mH}$ (high L_{stray})

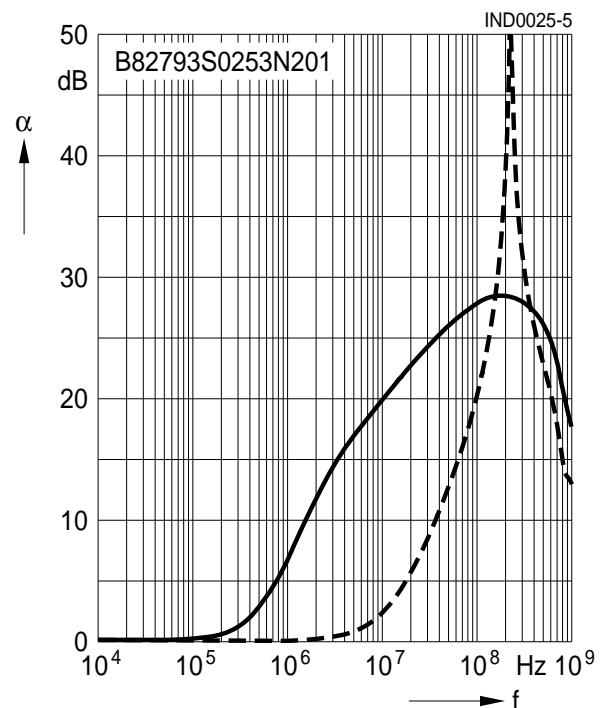
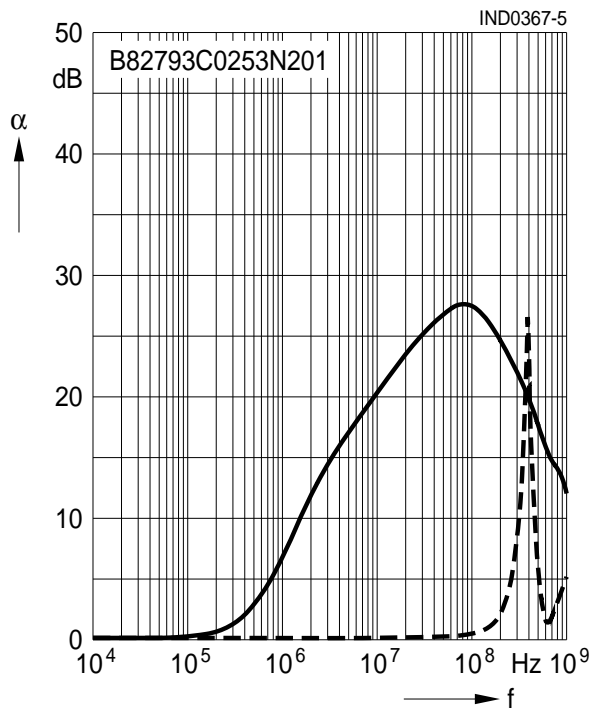

$L_R = 0.051 \text{ mH}$ (low L_{stray})

$L_R = 0.051 \text{ mH}$ (high L_{stray})

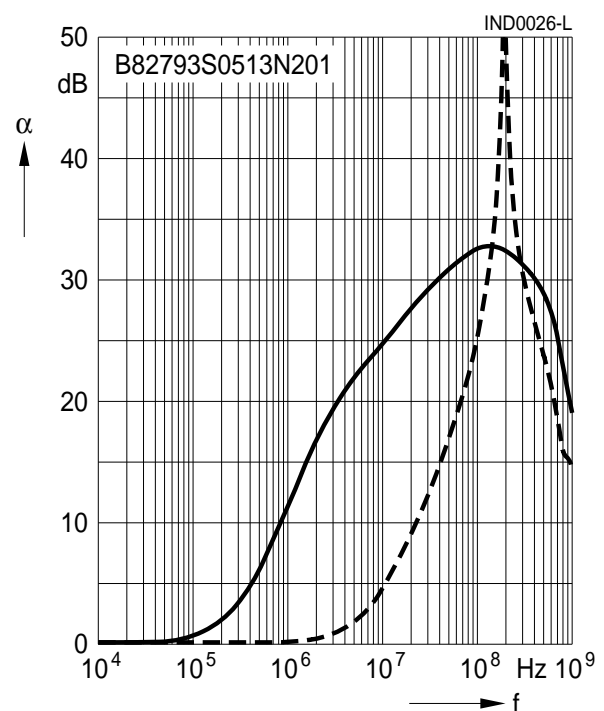
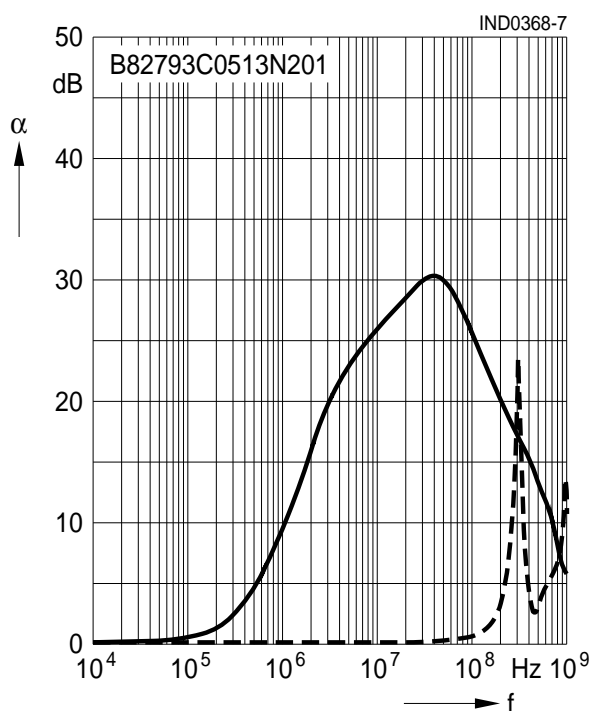

SMD

Insertion loss α (typical values at $|Z| = 50 \Omega$, 20°C)

———— asymmetrical, all branches in parallel (common mode)

- - - - - symmetrical (differential mode)

$L_R = 0.10 \text{ mH}$

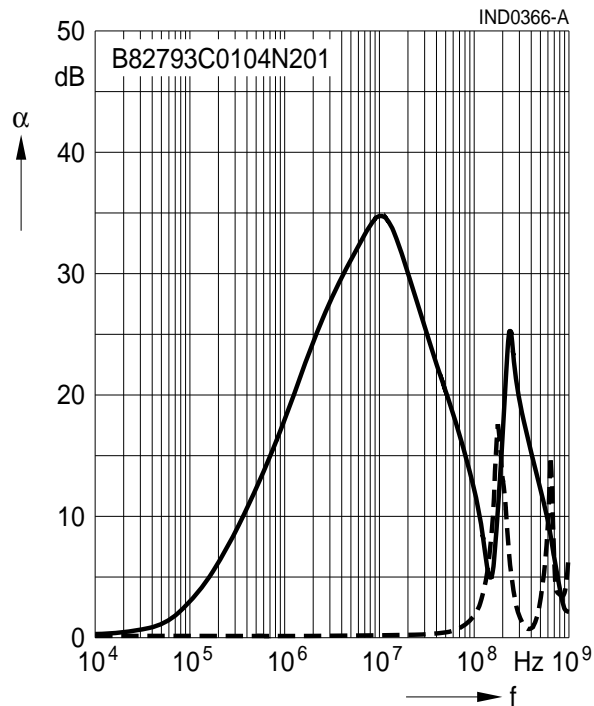

$L_R = 0.47 \text{ mH}$

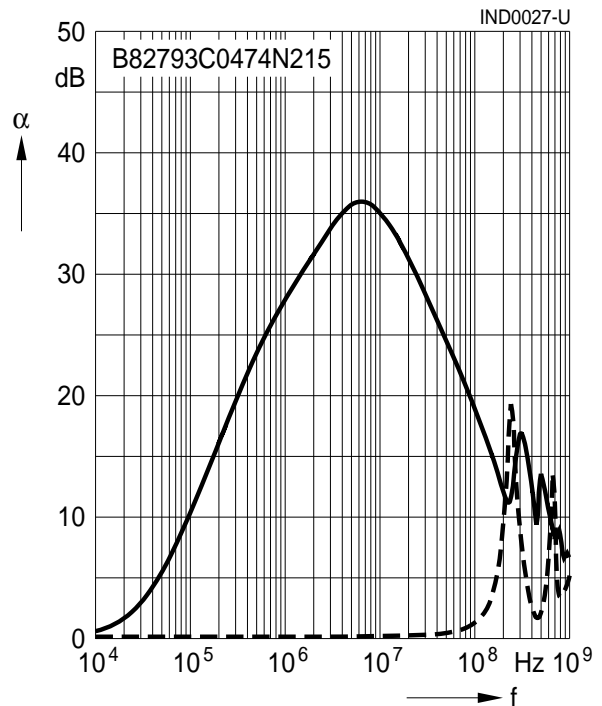

$L_R = 1.0 \text{ mH}$

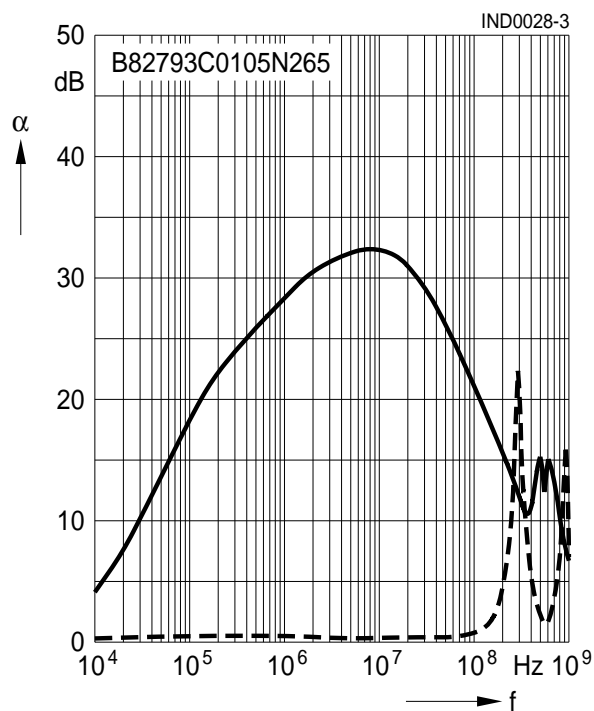

$L_R = 2.2 \text{ mH}$

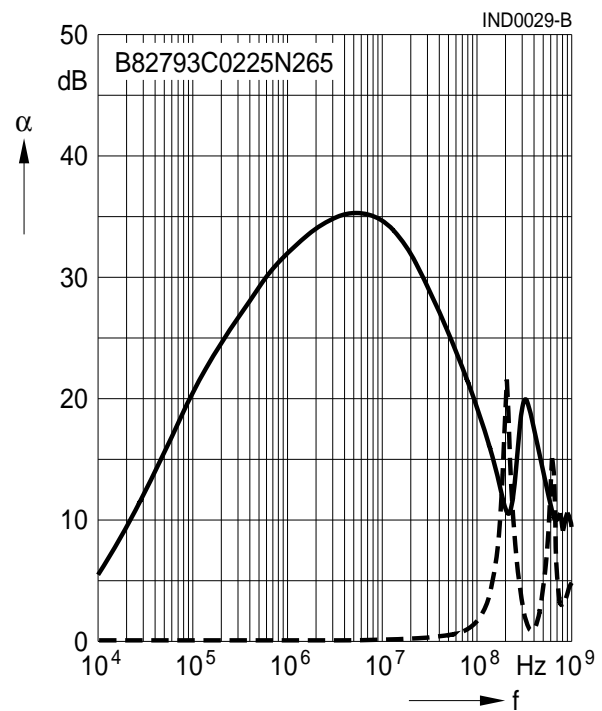

SMD

Insertion loss α (typical values at $|Z| = 50 \Omega$, 20°C)

———— asymmetrical, all branches in parallel (common mode)

- - - - - symmetrical (differential mode)

$L_R = 4.7 \text{ mH}$

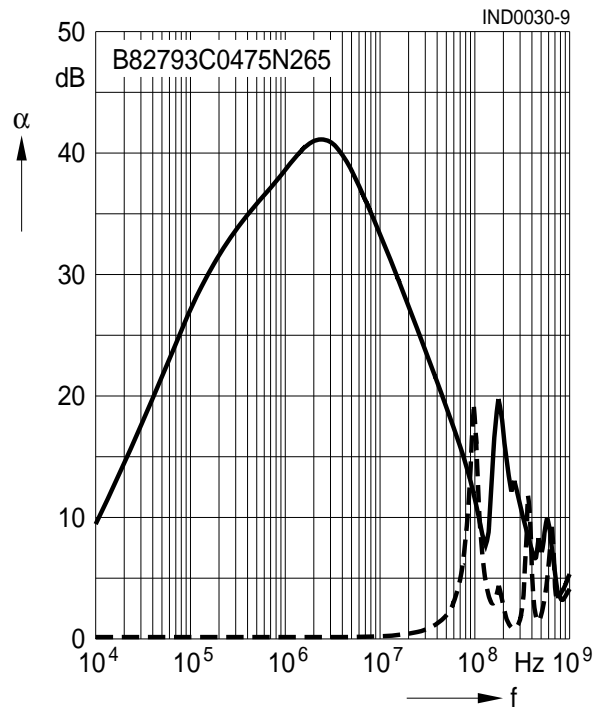

$L_R = 20 \text{ mH}$

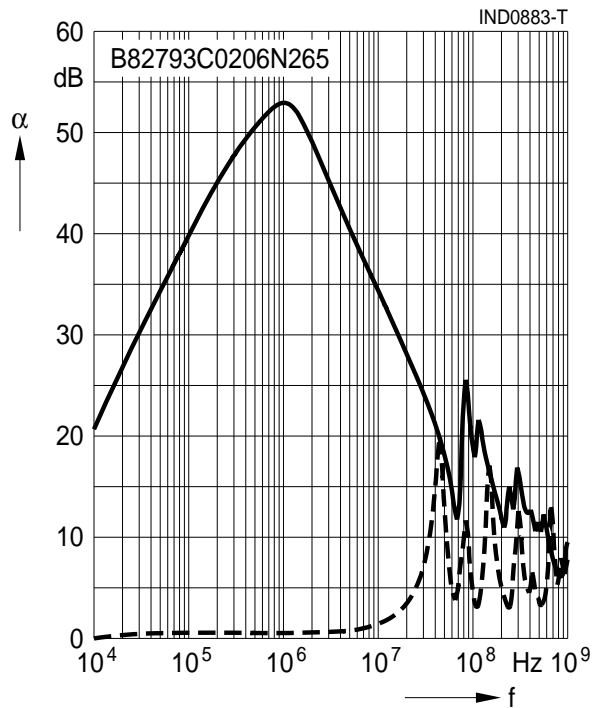

$L_R = 47 \text{ mH}$

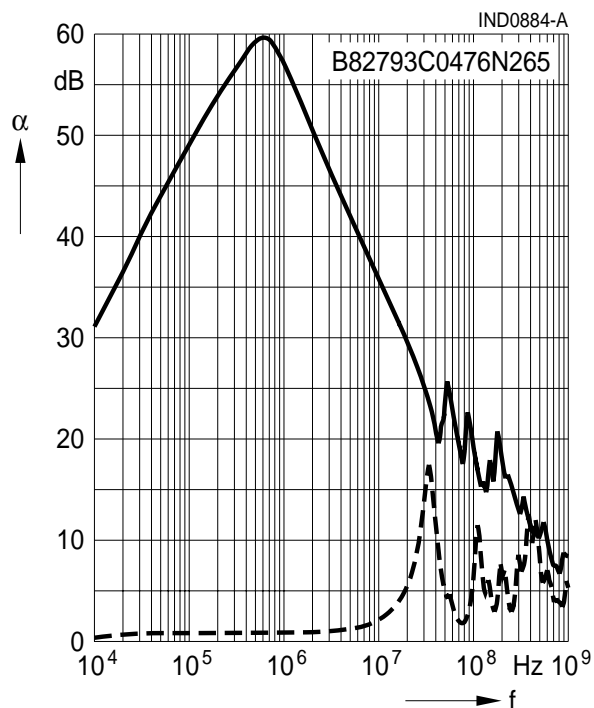

Current derating I_{op}/I_R versus ambient temperature

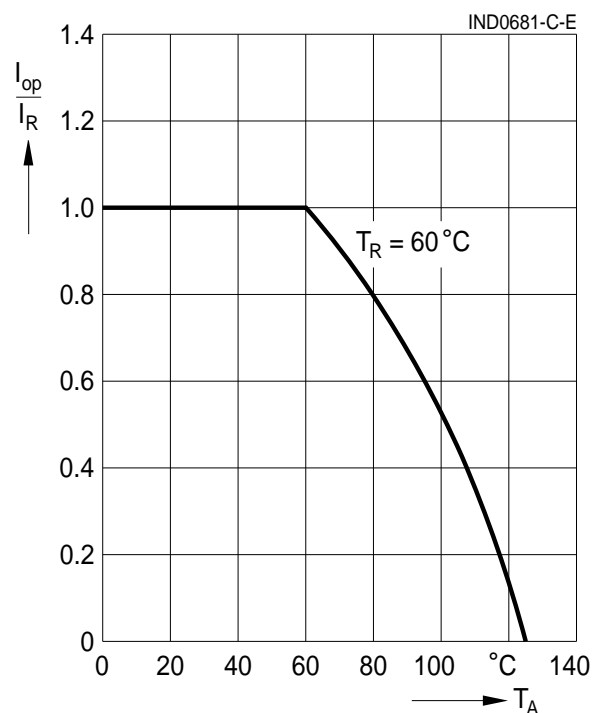

SMD

Recommended reflow soldering curve

Pb containing solder material (based on CECC 00802 edition 2)

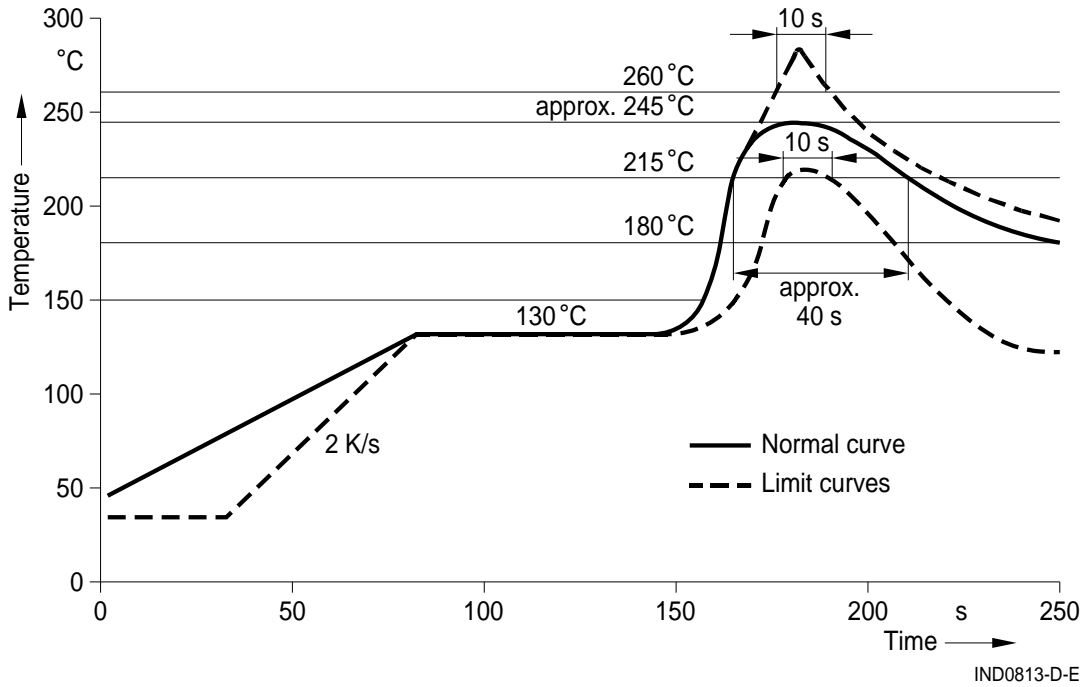

Pb-free solder material (based on JEDEC J-STD 020C)

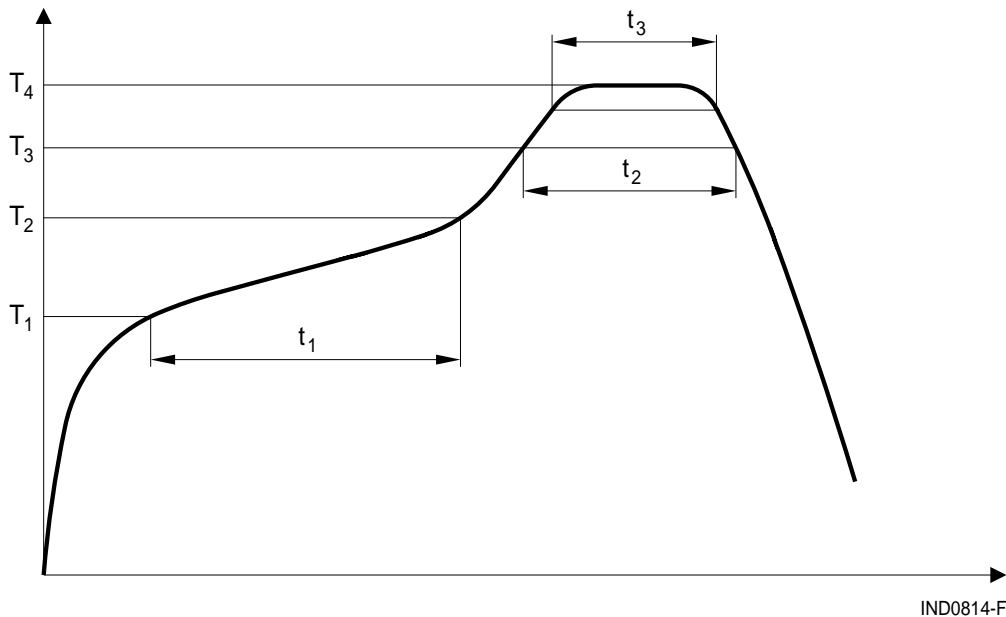

| T ₁ °C | T ₂ °C | T ₃ °C | T ₄ °C | t ₁ s | t ₂ s | t ₃ s |
|----------------------|----------------------|----------------------|----------------------|---------------------|---------------------|-----------------------------|
| 150 | 200 | 217 | 250 | < 110 | < 90 | < 40 @ T ₄ -5 °C |

Time from 25 °C to T₄: max 300 s

Maximal numbers of reflow cycles: 3

Cautions and warnings

- Please note the recommendations in our Inductors data book (latest edition) and in the data sheets.
 - Particular attention should be paid to the derating curves given there.
 - The soldering conditions should also be observed. Temperatures quoted in relation to wave soldering refer to the pin, not the housing.
- If the components are to be washed varnished it is necessary to check whether the washing varnish agent that is used has a negative effect on the wire insulation, any plastics that are used, or on glued joints. In particular, it is possible for washing varnish agent residues to have a negative effect in the long-term on wire insulation.
- The following points must be observed if the components are potted in customer applications:
 - Many potting materials shrink as they harden. They therefore exert a pressure on the plastic housing or core. This pressure can have a deleterious effect on electrical properties, and in extreme cases can damage the core or plastic housing mechanically.
 - It is necessary to check whether the potting material used attacks or destroys the wire insulation, plastics or glue.
 - The effect of the potting material can change the high-frequency behaviour of the components.
- Ferrites are sensitive to direct impact. This can cause the core material to flake, or lead to breakage of the core.
- Even for customer-specific products, conclusive validation of the component in the circuit can only be carried out by the customer.

Important notes

The following applies to all products named in this publication:

1. Some parts of this publication contain **statements about the suitability of our products for certain areas of application**. These statements are based on our knowledge of typical requirements that are often placed on our products in the areas of application concerned. We nevertheless expressly point out **that such statements cannot be regarded as binding statements about the suitability of our products for a particular customer application**.

As a rule, EPCOS is either unfamiliar with individual customer applications or less familiar with them than the customers themselves. For these reasons, it is always ultimately incumbent on the customer to check and decide whether an EPCOS product with the properties described in the product specification is suitable for use in a particular customer application.

2. We also point out that **in individual cases, a malfunction of electronic components or failure before the end of their usual service life cannot be completely ruled out in the current state of the art, even if they are operated as specified**. In customer applications requiring a very high level of operational safety and especially in customer applications in which the malfunction or failure of a passive electronic component could endanger human life or health (e.g. in accident prevention or life-saving systems), it must therefore be ensured by means of suitable design of the customer application or other action taken by the customer (e.g. installation of protective circuitry or redundancy) that no injury or damage is sustained by third parties in the event of malfunction or failure of a passive electronic component.
3. **The warnings, cautions and product-specific notes must be observed.**
4. In order to satisfy certain technical requirements, **some of the products described in this publication may contain substances subject to restrictions in certain jurisdictions (e.g. because they are classed as hazardous)**. Useful information on this will be found in our Material Data Sheets on the Internet (www.epcos.com/material). Should you have any more detailed questions, please contact our sales offices.
5. We constantly strive to improve our products. Consequently, **the products described in this publication may change from time to time**. The same is true of the corresponding product specifications. Please check therefore to what extent product descriptions and specifications contained in this publication are still applicable before or when you place an order.

We also **reserve the right to discontinue production and delivery of products**. Consequently, we cannot guarantee that all products named in this publication will always be available.

The aforementioned does not apply in the case of individual agreements deviating from the foregoing for customer-specific products.

6. Unless otherwise agreed in individual contracts, **all orders are subject to the current version of the “General Terms of Delivery for Products and Services in the Electrical Industry” published by the German Electrical and Electronics Industry Association (ZVEI)**.
7. The trade names EPCOS, BAOKE, Alu-X, CeraDiode, CSSP, CTVS, DSSP, MiniBlue, MKK, MLSC, MotorCap, PCC, PhaseCap, PhaseMod, SIFERRIT, SIFI, SIKOREL, SilverCap, SIMDAD, SIMID, SineFormer, SIOV, SIP5D, SIP5K, ThermoFuse, WindCap are **trademarks registered or pending** in Europe and in other countries. Further information will be found on the Internet at www.epcos.com/trademarks.