

BT168GW

Thyristors; logic level for RCD/GFI/LCCB applications

Rev. 04 — 12 November 2004

Product data sheet

1. Product profile

1.1 General description

Passivated, sensitive gate thyristor in a SOT223 plastic package.

1.2 Features

- Designed to be interfaced directly to microcontrollers, logic integrated circuits and other low power gate trigger circuits.

1.3 Applications

- For use in Residual Current Devices (RCD), Ground Fault Interrupters (GFI) and Leakage Current Circuit Breakers (LCCB) applications where a minimum I_{GT} limit is needed.

1.4 Quick reference data

- $V_{DRM} \leq 600$ V
- $V_{RRM} \leq 600$ V
- $I_{T(AV)} \leq 0.6$ A
- $I_{T(RMS)} \leq 1$ A
- $I_{TSM} \leq 8$ A
- $I_{GT} = 50$ μ A (typical).

2. Pinning information

Table 1: Pinning

Pin	Description	Simplified outline	Symbol
1	cathode	 SOT223	 <i>sym037</i>
2	anode		
3	gate		
4	anode		

3. Ordering information

Table 2: Ordering information

Type number	Package		Version
	Name	Description	
BT168GW	SC-73	plastic surface mounted package with increased heatsink; 4 leads	SOT223

PHILIPS

4. Limiting values

Table 3: Limiting values

In accordance with the Absolute Maximum Rating System (IEC 60134).

Symbol	Parameter	Conditions	Min	Max	Unit
V_{DRM}, V_{RRM}	repetitive peak off-state voltage		[1] -	600	V
$I_{T(AV)}$	average on-state current	half sine wave; $T_{sp} \leq 112\text{ }^\circ\text{C}$; see Figure 1	-	0.63	A
$I_{T(RMS)}$	RMS on-state current	all conduction angles; see Figure 4 and 5	-	1	A
I_{TSM}	non-repetitive peak on-state current	half sine wave; $T_j = 25\text{ }^\circ\text{C}$ prior to surge; see Figure 2 and 3	-	8	A
		$t = 10\text{ ms}$	-	9	A
		$t = 8.3\text{ ms}$	-	9	A
I^2t	I^2t for fusing	$t = 10\text{ ms}$	-	0.32	A^2s
di_T/dt	repetitive rate of rise of on-state current after triggering	$I_{TM} = 2\text{ A}$; $I_G = 10\text{ mA}$; $di_G/dt = 100\text{ mA}/\mu\text{s}$	-	50	$\text{A}/\mu\text{s}$
I_{GM}	peak gate current		-	1	A
V_{GM}	peak gate voltage		-	5	V
V_{RGM}	peak reverse gate voltage		-	5	V
P_{GM}	peak gate power		-	2	W
$P_{G(AV)}$	average gate power	over any 20 ms period	-	0.1	W
T_{stg}	storage temperature		-40	+150	$^\circ\text{C}$
T_j	junction temperature		-	125	$^\circ\text{C}$

[1] Although not recommended, off-state voltages up to 800 V may be applied without damage, but the thyristor may switch to the on-state. The rate of rise of current should not exceed 15 A/ μs .

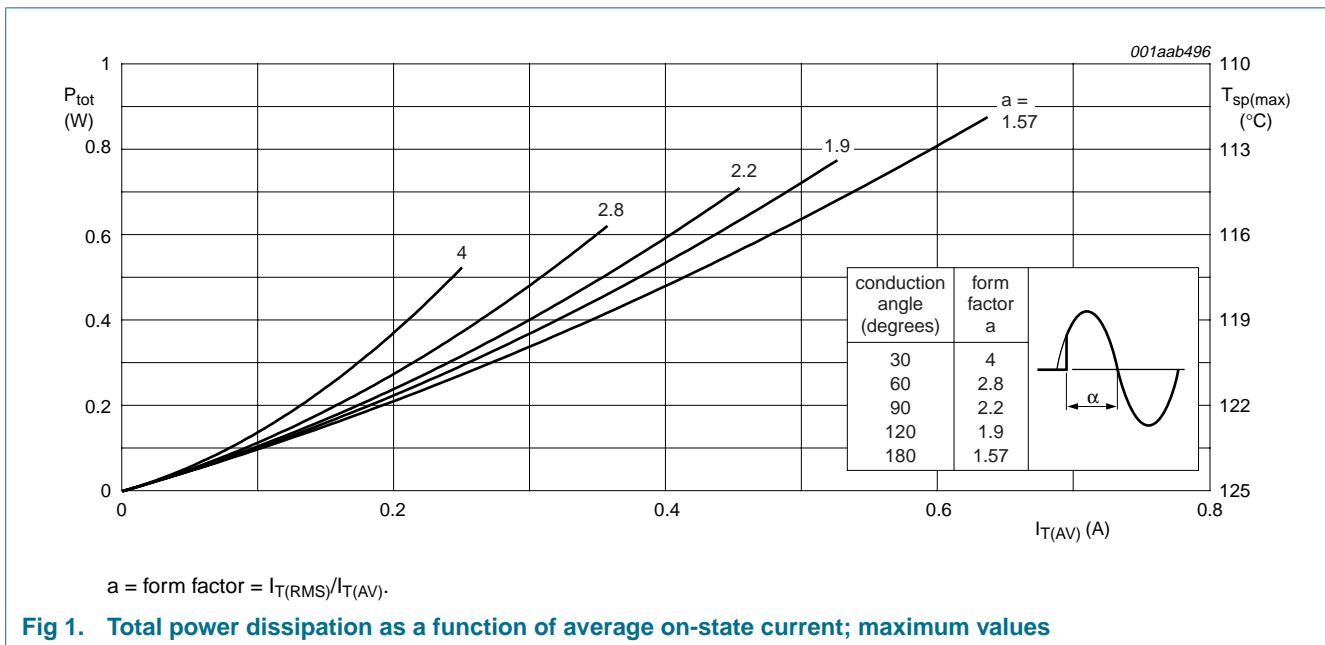

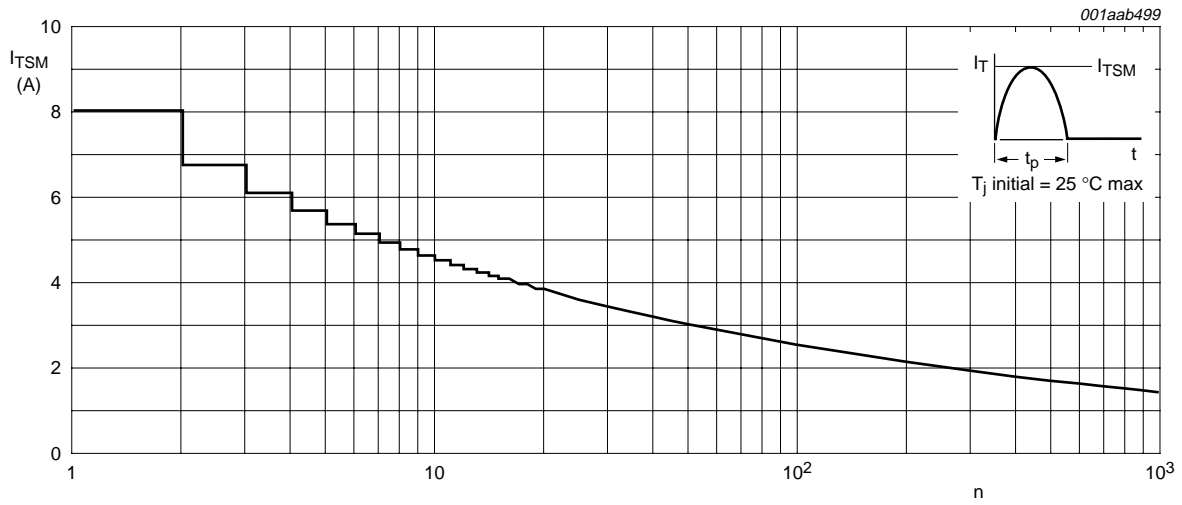

$f = 50$ Hz.

Fig 2. Non-repetitive peak on-state current as a function of the number of sinusoidal current cycles; maximum values

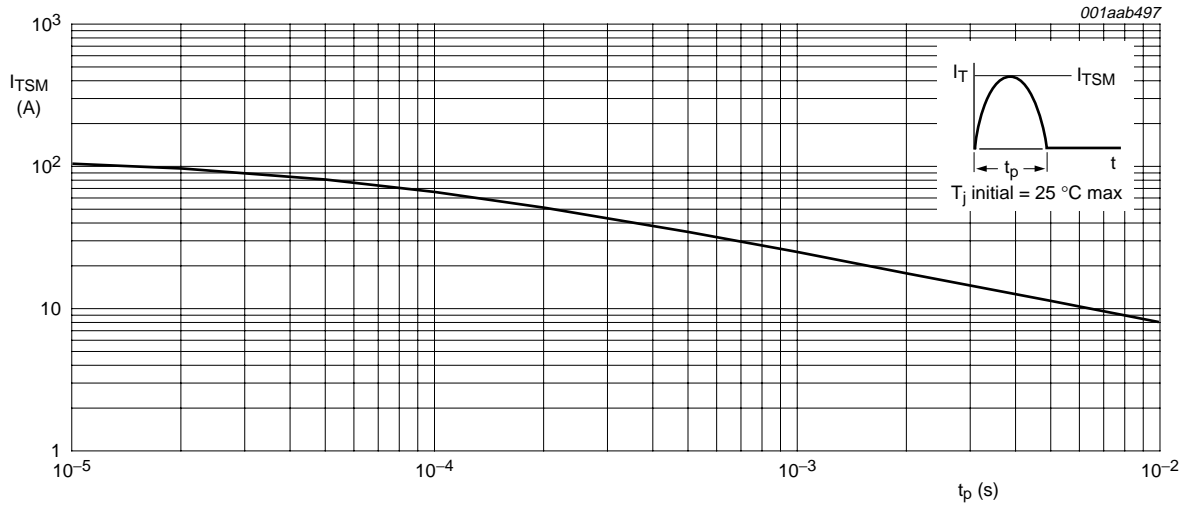

$t_p \leq 10$ ms.

Fig 3. Non-repetitive peak on-state current as a function of pulse width for sinusoidal currents; maximum values

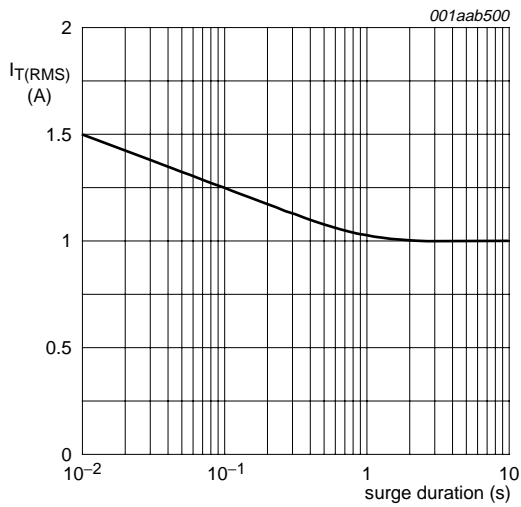

$f = 50 \text{ Hz}; T_{sp} \leq 112 \text{ }^\circ\text{C}$.

Fig 4. RMS on-state current as a function of surge duration for sinusoidal currents; maximum values

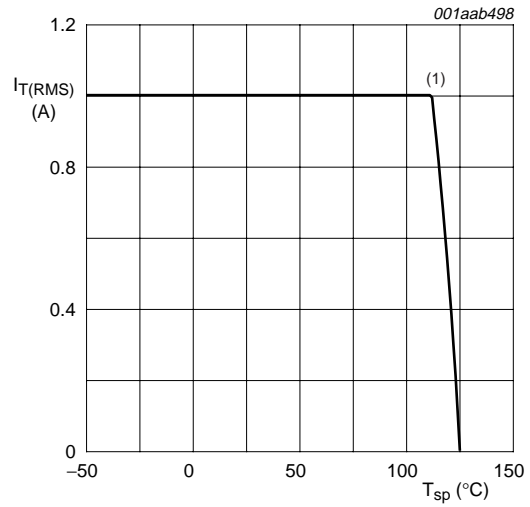

(1) $T_{sp} = 112 \text{ }^\circ\text{C}$.

Fig 5. RMS on-state current as a function of solder point temperature; maximum values

5. Thermal characteristics

Table 4: Thermal characteristics

Symbol	Parameter	Conditions	Min	Typ	Max	Unit
$R_{th(j-sp)}$	thermal resistance from junction to solder point	see Figure 6	-	-	15	K/W
$R_{th(j-a)}$	thermal resistance from junction to ambient	printed-circuit board mounted, minimum footprint	-	156	-	K/W
		printed-circuit board mounted, pad area as in Figure 15	-	70	-	K/W

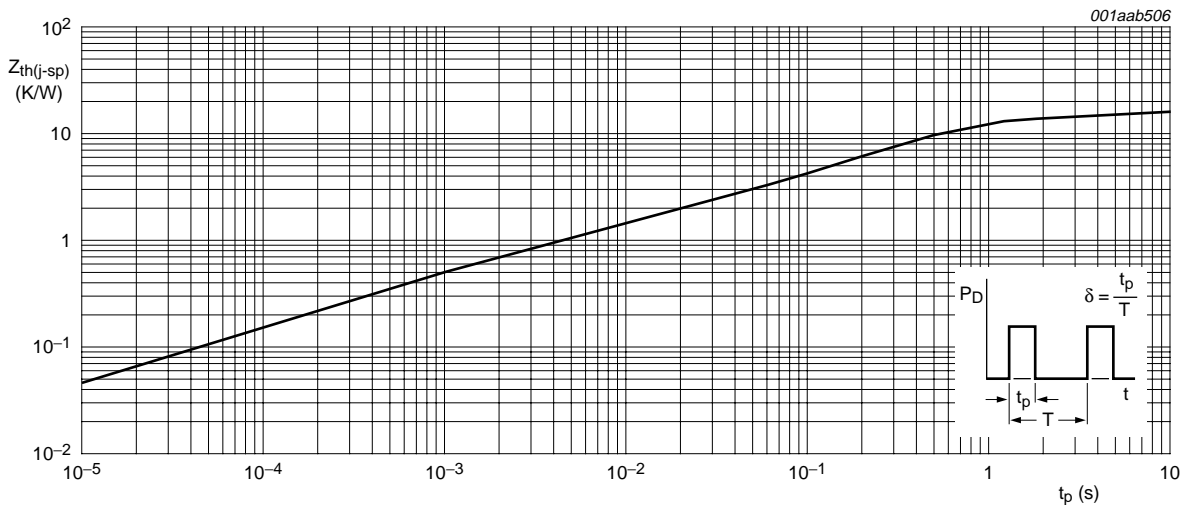

Fig 6. Transient thermal impedance from junction to solder point as a function of pulse duration

6. Characteristics

Table 5: Characteristics

$T_j = 25\text{ }^\circ\text{C}$; unless otherwise stated

Symbol	Parameter	Conditions	Min	Typ	Max	Unit
Static characteristics						
I_{GT}	gate trigger current	$V_D = 12\text{ V}$; $I_T = 10\text{ mA}$; gate open circuit; see Figure 8	20	50	200	μA
I_L	latching current	$V_D = 12\text{ V}$; $I_{GT} = 0.5\text{ mA}$; $R_{GK} = 1\text{ k}\Omega$; see Figure 10	-	2	6	mA
I_H	holding current	$V_D = 12\text{ V}$; $I_{GT} = 0.5\text{ mA}$; $R_{GK} = 1\text{ k}\Omega$; see Figure 11	-	2	5	mA
V_T	on-state voltage	$I_T = 1.2\text{ A}$	-	1.25	1.7	V
V_{GT}	gate trigger voltage	$I_T = 10\text{ mA}$; gate open circuit; see Figure 7	-	0.5	0.8	V
		$V_D = 12\text{ V}$	-	0.5	0.8	V
		$V_D = V_{DRM(max)}$; $T_j = 125\text{ }^\circ\text{C}$	0.2	0.3	-	V
I_D, I_R	off-state leakage current	$V_D = V_{DRM(max)}$; $V_R = V_{RRM(max)}$; $T_j = 125\text{ }^\circ\text{C}$; $R_{GK} = 1\text{ k}\Omega$	-	0.05	0.1	mA
Dynamic characteristics						
dV_D/dt	critical rate of rise of off-state voltage	$V_{DM} = 67\% V_{DRM(max)}$; $T_j = 125\text{ }^\circ\text{C}$; exponential waveform; see Figure 12	-	-	-	-
		$R_{GK} = 1\text{ k}\Omega$	500	800	-	$\text{V}/\mu\text{s}$
		gate open circuit	-	25	-	$\text{V}/\mu\text{s}$
t_{gt}	gate controlled turn-on time	$I_{TM} = 2\text{ A}$; $V_D = V_{DRM(max)}$; $I_G = 10\text{ mA}$; $dI_G/dt = 0.1\text{ A}/\mu\text{s}$	-	2	-	μs
t_q	circuit commuted turn-off time	$V_D = 67\% V_{DRM(max)}$; $T_j = 125\text{ }^\circ\text{C}$; $I_{TM} = 1.6\text{ A}$; $V_R = 35\text{ V}$; $dI_{TM}/dt = 30\text{ A}/\mu\text{s}$; $dV_D/dt = 2\text{ V}/\mu\text{s}$; $R_{GK} = 1\text{ k}\Omega$	-	100	-	μs

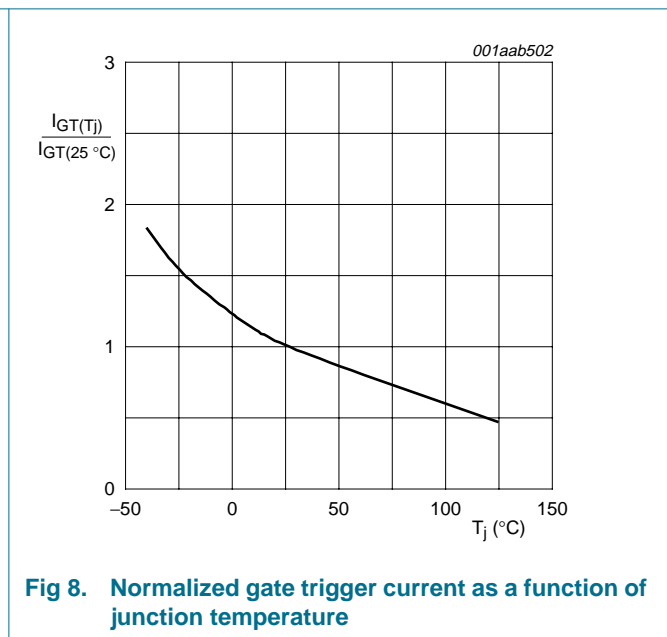
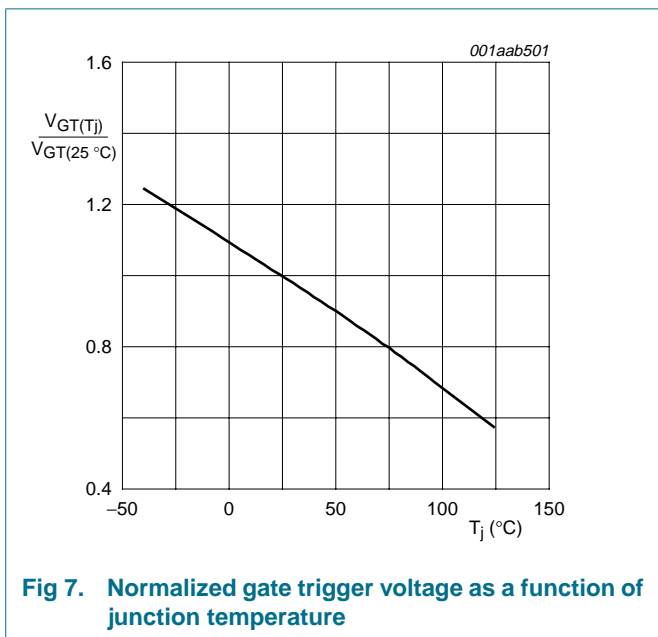

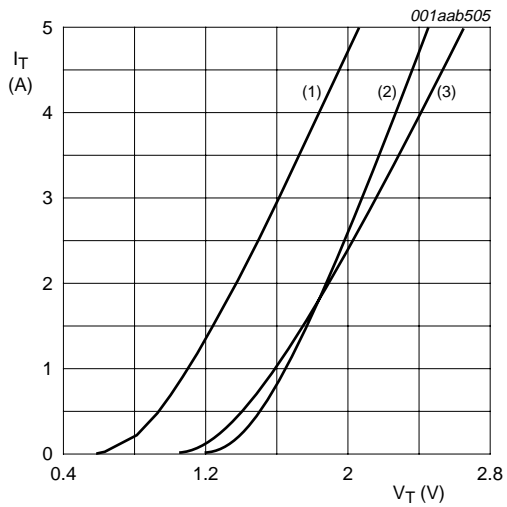

$V_O = 1.0 \text{ V.}$
 $R_S = 0.27 \Omega.$

- (1) $T_j = 125 \text{ }^\circ\text{C}$ (typical).
- (2) $T_j = 25 \text{ }^\circ\text{C}$ (maximum).
- (3) $T_j = 125 \text{ }^\circ\text{C}$ (maximum).

Fig 9. On-state current characteristics

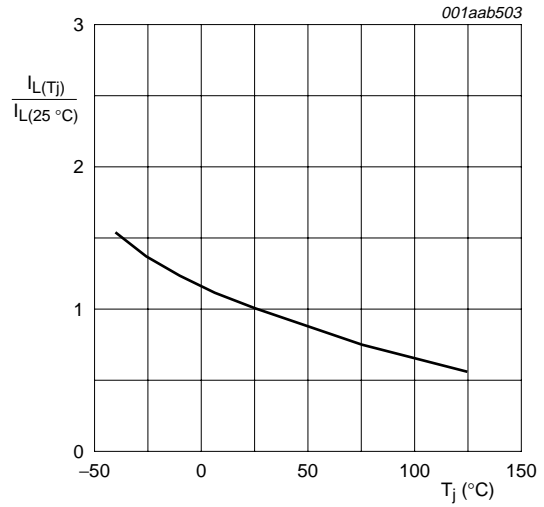

$R_{GK} = 1 \text{ k}\Omega.$

Fig 10. Normalized latching current as a function of junction temperature

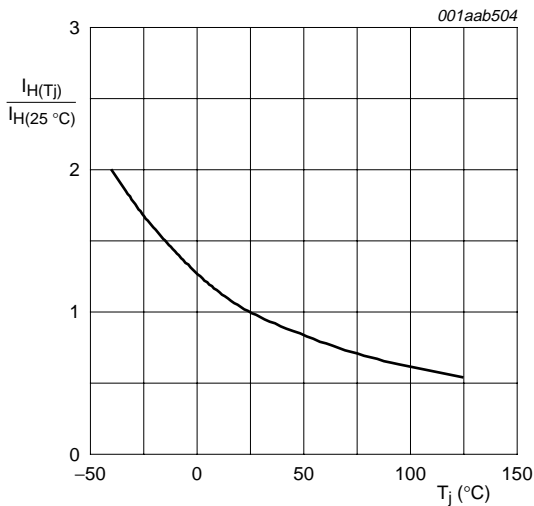

$R_{GK} = 1 \text{ k}\Omega.$

Fig 11. Normalized holding current as a function of junction temperature

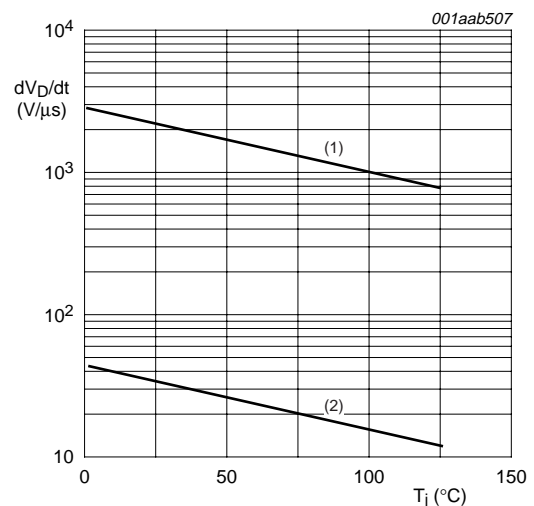

- (1) $R_{GK} = 1 \text{ k}\Omega.$
- (2) Gate open circuit.

Fig 12. Critical rate of rise of off-state voltage as a function of junction temperature; typical values

7. Package information

Epoxy meets requirements of UL94 V-0 at $\frac{1}{8}$ inch.

8. Package outline

Plastic surface mounted package with increased heatsink; 4 leads

SOT223

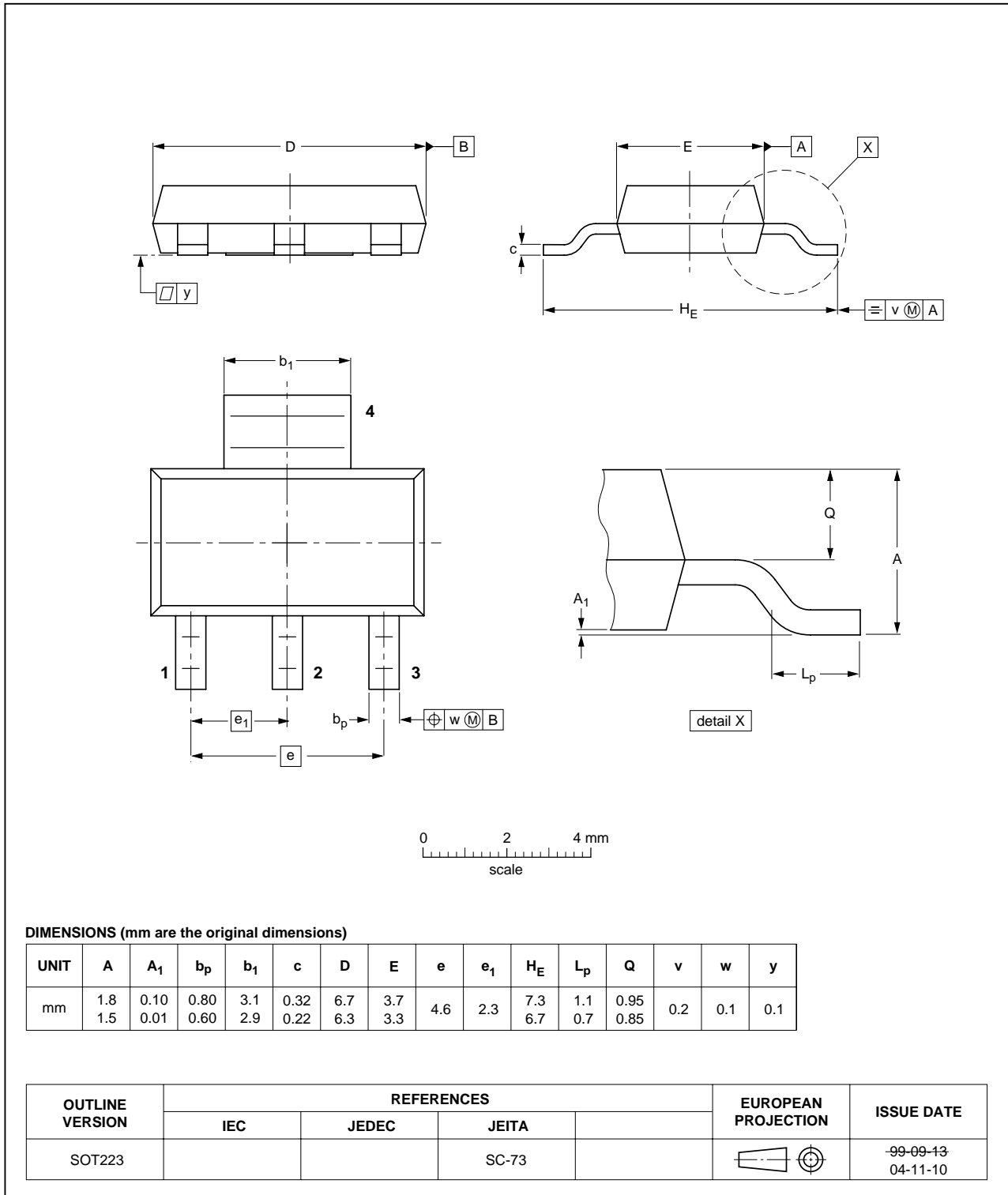
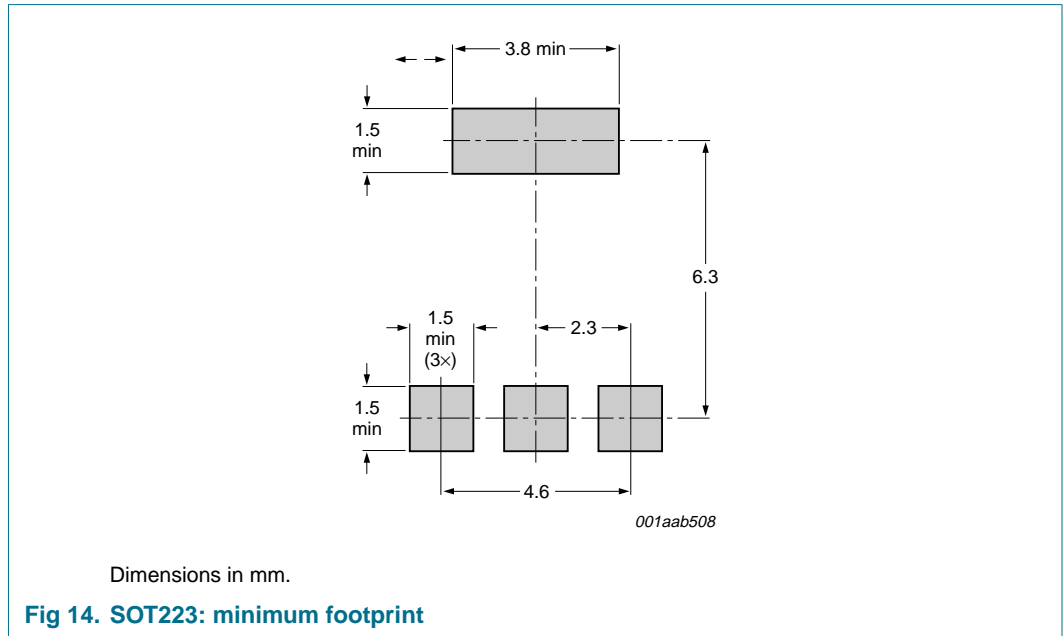

Fig 13. Package outline SOT223 (SC-73)

9. Mounting

9.1 Mounting instructions



9.2 Printed-circuit board

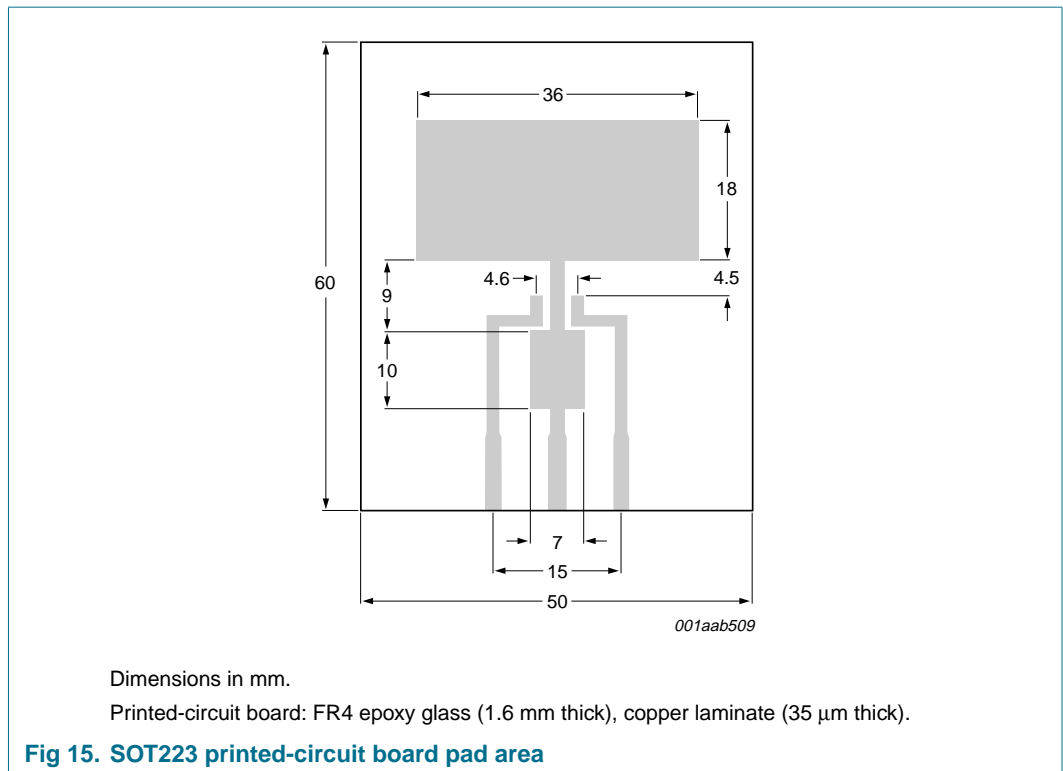

10. Revision history

Table 6: Revision history

Document ID	Release date	Data sheet status	Change notice	Doc. number	Supersedes
BT168GW_4	20041112	Product data sheet	-	9397 750 13509	BT168GW_3
Modifications:	<ul style="list-style-type: none">The format of this data sheet has been redesigned to comply with the new presentation and information standard of Philips Semiconductors.				
BT168GW_3	20010902	Product specification	-	n.a.	BT168W_series_2
BT168W_series_2	20010901	Product specification	-	n.a.	BT168W_series_1
BT168W_series_1	19970901	Product specification	-	n.a.	-

11. Data sheet status

Level	Data sheet status ^[1]	Product status ^[2] ^[3]	Definition
I	Objective data	Development	This data sheet contains data from the objective specification for product development. Philips Semiconductors reserves the right to change the specification in any manner without notice.
II	Preliminary data	Qualification	This data sheet contains data from the preliminary specification. Supplementary data will be published at a later date. Philips Semiconductors reserves the right to change the specification without notice, in order to improve the design and supply the best possible product.
III	Product data	Production	This data sheet contains data from the product specification. Philips Semiconductors reserves the right to make changes at any time in order to improve the design, manufacturing and supply. Relevant changes will be communicated via a Customer Product/Process Change Notification (CPCN).

[1] Please consult the most recently issued data sheet before initiating or completing a design.

[2] The product status of the device(s) described in this data sheet may have changed since this data sheet was published. The latest information is available on the Internet at URL <http://www.semiconductors.philips.com>.

[3] For data sheets describing multiple type numbers, the highest-level product status determines the data sheet status.

12. Definitions

Short-form specification — The data in a short-form specification is extracted from a full data sheet with the same type number and title. For detailed information see the relevant data sheet or data handbook.

Limiting values definition — Limiting values given are in accordance with the Absolute Maximum Rating System (IEC 60134). Stress above one or more of the limiting values may cause permanent damage to the device. These are stress ratings only and operation of the device at these or at any other conditions above those given in the Characteristics sections of the specification is not implied. Exposure to limiting values for extended periods may affect device reliability.

Application information — Applications that are described herein for any of these products are for illustrative purposes only. Philips Semiconductors make no representation or warranty that such applications will be suitable for the specified use without further testing or modification.

13. Disclaimers

Life support — These products are not designed for use in life support appliances, devices, or systems where malfunction of these products can reasonably be expected to result in personal injury. Philips Semiconductors customers using or selling these products for use in such applications do so at their own risk and agree to fully indemnify Philips Semiconductors for any damages resulting from such application.

Right to make changes — Philips Semiconductors reserves the right to make changes in the products - including circuits, standard cells, and/or software - described or contained herein in order to improve design and/or performance. When the product is in full production (status 'Production'), relevant changes will be communicated via a Customer Product/Process Change Notification (CPCN). Philips Semiconductors assumes no responsibility or liability for the use of any of these products, conveys no license or title under any patent, copyright, or mask work right to these products, and makes no representations or warranties that these products are free from patent, copyright, or mask work right infringement, unless otherwise specified.

14. Contact information

For additional information, please visit: <http://www.semiconductors.philips.com>

For sales office addresses, send an email to: sales.addresses@www.semiconductors.philips.com

15. Contents

1	Product profile	1
1.1	General description	1
1.2	Features	1
1.3	Applications	1
1.4	Quick reference data	1
2	Pinning information	1
3	Ordering information	1
4	Limiting values	2
5	Thermal characteristics	4
6	Characteristics	5
7	Package information	6
8	Package outline	7
9	Mounting	8
9.1	Mounting instructions	8
9.2	Printed-circuit board	8
10	Revision history	9
11	Data sheet status	10
12	Definitions	10
13	Disclaimers	10
14	Contact information	10



© Koninklijke Philips Electronics N.V. 2004

All rights are reserved. Reproduction in whole or in part is prohibited without the prior written consent of the copyright owner. The information presented in this document does not form part of any quotation or contract, is believed to be accurate and reliable and may be changed without notice. No liability will be accepted by the publisher for any consequence of its use. Publication thereof does not convey nor imply any license under patent- or other industrial or intellectual property rights.

Date of release: 12 November 2004
Document number: 9397 750 13509

Published in The Netherlands