

TOSHIBA LED LAMP

**TLSU1102 (T10), TLOU1102 (T10), TLYU1102 (T10)
TLGU1102 (T10), TLPGU1102 (T10)**

PANEL CIRCUIT INDICATOR

Unit in mm

- Surface Mount Device
- 3.2 (L) × 2.8 (W) × 3.4 (H) mm Size
- φ2.8 mm Diameter Lens-top Type
- InGaAlP LED
- Line-up
Colors : Red, Orange, Yellow, Green, Pure Green
- Available of Automounting Machine Use
- Low Drive Current, High Intensity Light Emission
- Clear luminescence is obtained.
- High Operating Temperature : $T_{opr} \cdot T_{stg} \quad -40 \sim 100^{\circ}\text{C}$
- Reflow soldering is possible.
- Standard embossed taping
8 mm Pitch : T10 (500 pcs / reel)
- Applications : Automotive use, Message Signboard, Backlight, etc.

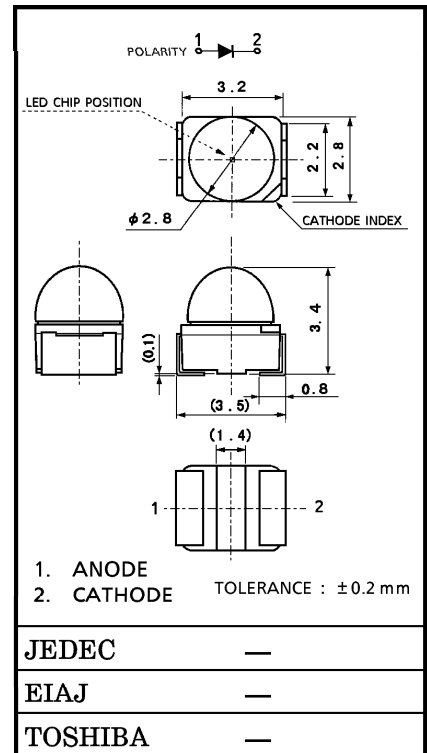

Weight : 42 mg

LINE-UP

PRODUCT NAME	COLOR	MATERIAL
TLSU1102	Red	InGaAlP
TLOU1102	Orange	InGaAlP
TLYU1102	Yellow	InGaAlP
TLGU1102	Green	InGaAlP
TLPGU1102	Pure Green	InGaAlP

MAXIMUM RATINGS (Ta = 25°C)

PRODUCT NAME	FORWARD CURRENT I _F (mA)	REVERSE VOLTAGE V _R (V)	POWER DISSIPATION P _D (mW)	OPERATING TEMPERATURE T _{opr} (°C)	STORAGE TEMPERATURE T _{stg} (°C)
TLSU1102	30	4	72	-40~100	-40~100
TLOU1102	30	4	72		
TLYU1102	30	4	75		
TLGU1102	30	4	84		
TLPGU1102	30	4	84		

961001EAC1

- TOSHIBA is continually working to improve the quality and the reliability of its products. Nevertheless, semiconductor devices in general can malfunction or fail due to their inherent electrical sensitivity and vulnerability to physical stress. It is the responsibility of the buyer, when utilizing TOSHIBA products, to observe standards of safety, and to avoid situations in which a malfunction or failure of a TOSHIBA product could cause loss of human life, bodily injury or damage to property. In developing your designs, please ensure that TOSHIBA products are used within specified operating ranges as set forth in the most recent products specifications. Also, please keep in mind the precautions and conditions set forth in the TOSHIBA Semiconductor Reliability Handbook.
- Gallium arsenide (GaAs) is a substance used in the products described in this document. GaAs dust and fumes are toxic. Do not break, cut or pulverize the product, or use chemicals to dissolve them. When disposing of the products, follow the appropriate regulations. Do not dispose of the products with other industrial waste or with domestic garbage.
- The information contained herein is presented only as a guide for the applications of our products. No responsibility is assumed by TOSHIBA CORPORATION for any infringements of intellectual property or other rights of the third parties which may result from its use. No license is granted by implication or otherwise under any intellectual property or other rights of TOSHIBA CORPORATION or others.
- The information contained herein is subject to change without notice.

ELECTRICAL CHARACTERISTICS (Ta = 25°C)

PRODUCT NAME	FORWARD VOLTAGE V _F				REVERSE CURRENT I _R	
	MIN	TYP.	MAX	I _F	MAX	V _R
TLSU1102	—	2.0	2.4	20	50	4
TLOU1102	—	2.0	2.4	20	50	4
TLYU1102	—	2.1	2.5	20	50	4
TLGU1102	—	2.3	2.8	20	50	4
TLPGU1102	—	2.3	2.8	20	50	4
Unit	V			mA	μA	V

OPTICAL CHARACTERISTICS-1 (Ta = 25°C)

PRODUCT NAME	LUMINOUS INTENSITY I _v			
	MIN	TYP.	MAX	I _F
TLSU1102	85	200	—	20
TLOU1102	85	250	—	20
TLYU1102	47.6	130	—	20
TLGU1102	47.6	120	—	20
TLPGU1102	8.5	30	—	20
Unit	mcd			mA

OPTICAL CHARACTERISTICS-2 (Ta = 25°C)

PRODUCT NAME	EMISSION SPECTRUM							I _F
	Peak Emission Wavelength λ _p			Δλ TYP.	Dominant Wavelength λ _d			
	MIN	TYP.	MAX		MIN	TYP.	MAX	
TLSU1102	—	636	—	17	—	623	—	20
TLOU1102	—	612	—	15	—	605	—	20
TLYU1102	—	590	—	13	—	587	—	20
TLGU1102	—	574	—	11	—	571	—	20
TLPGU1102	—	562	—	11	—	558	—	20
UNIT	nm			nm	nm			mA

(Note) : This visible LED lamp also emits some IR light.
 If a photodetector is located near the LED lamp, please ensure that it will not be affected by this IR light.

TL SU1102

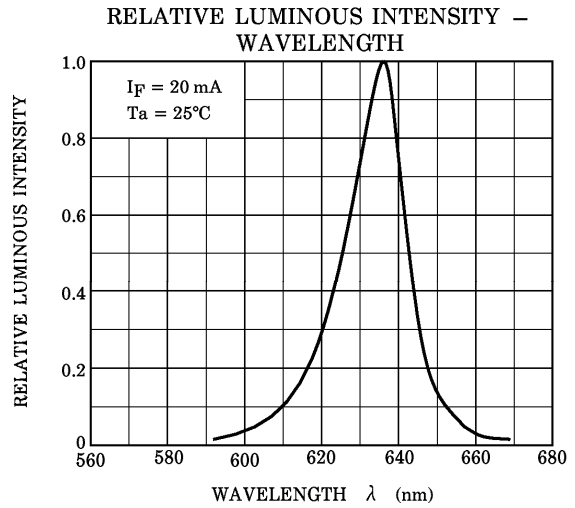
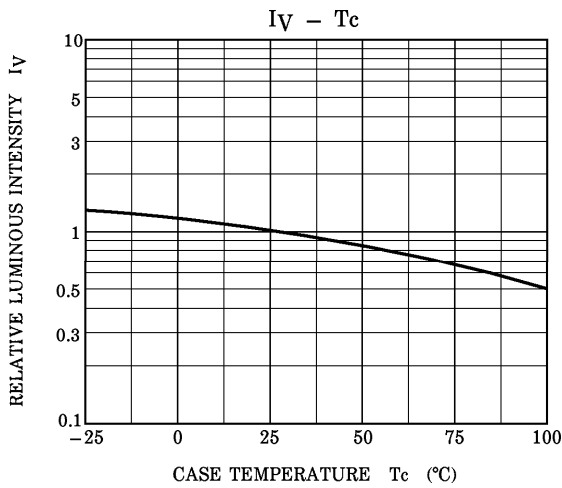
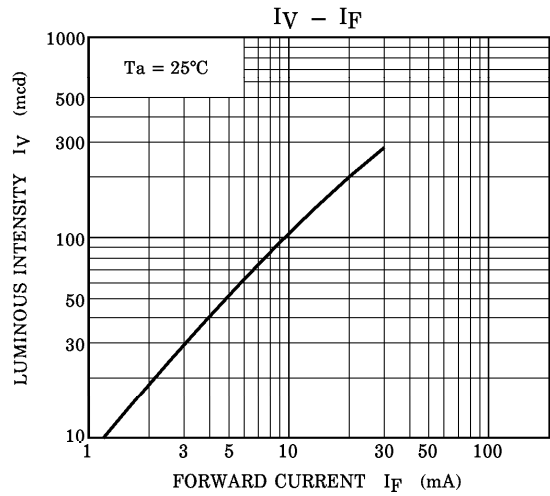
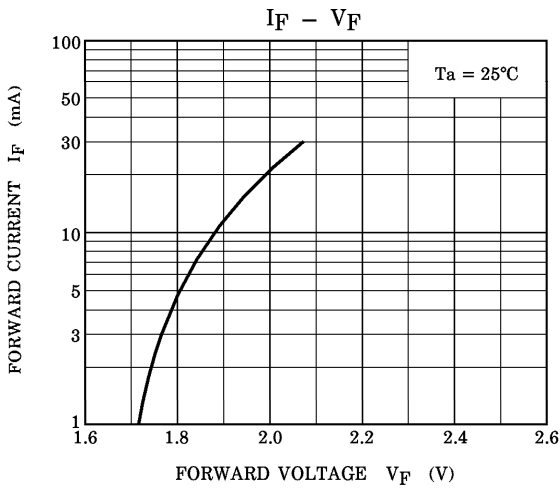

RADIATION PATTERN

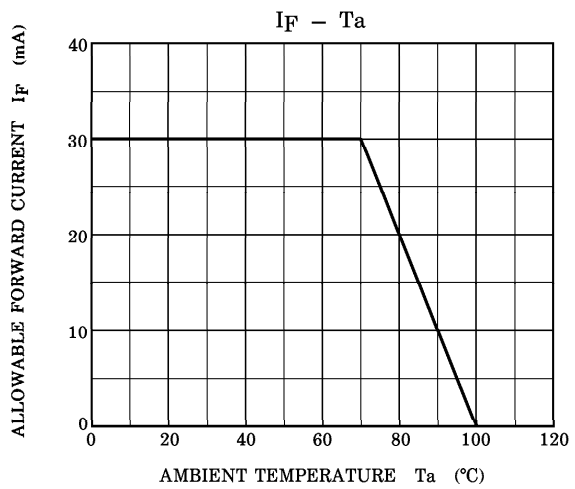
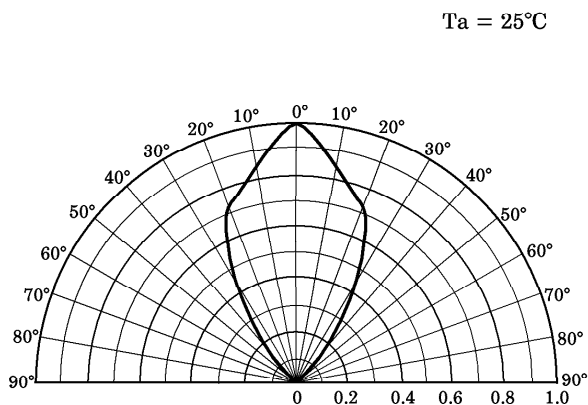

TLOU1102

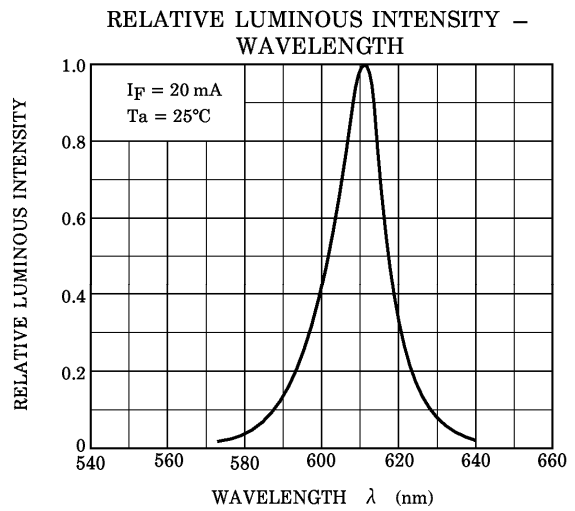
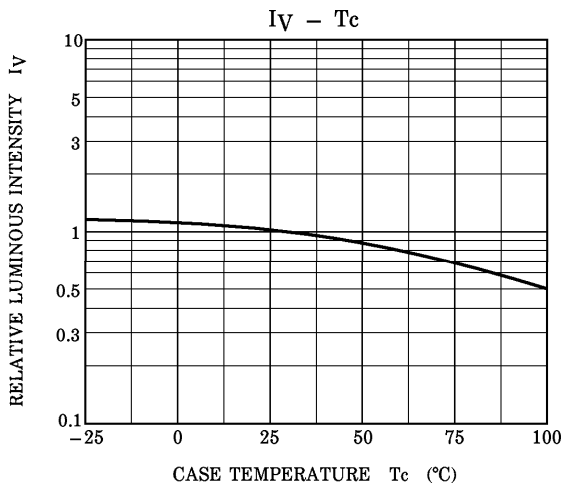
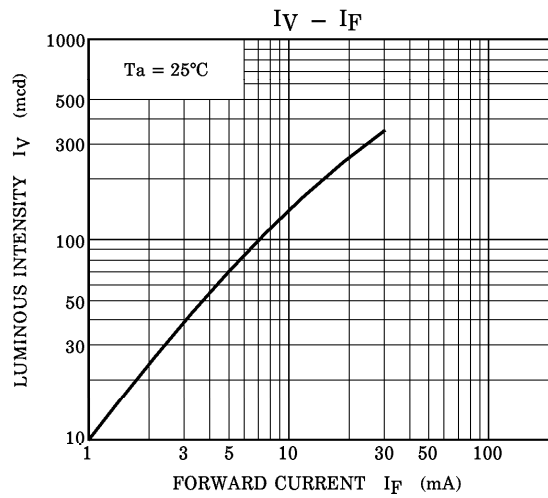
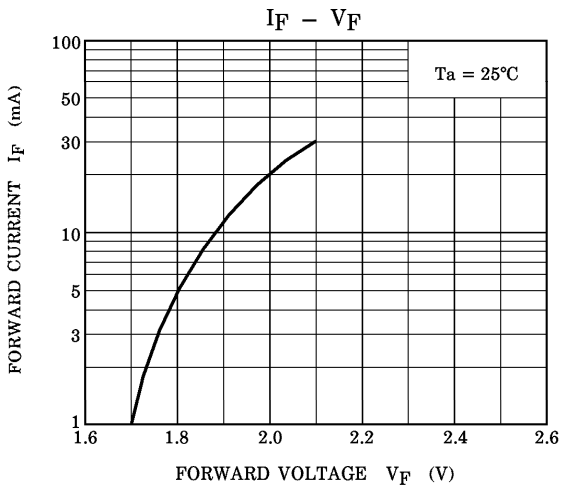

RADIATION PATTERN

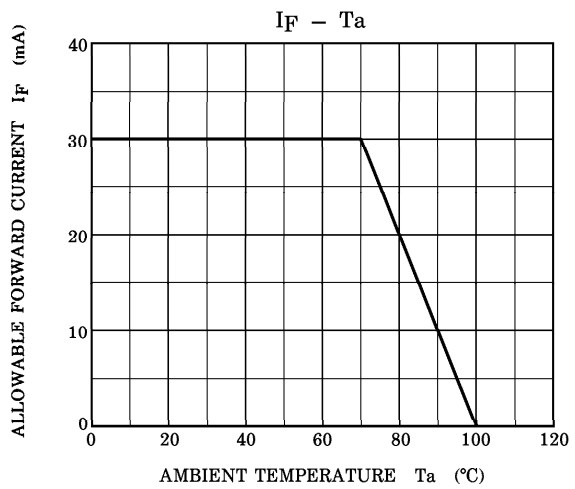
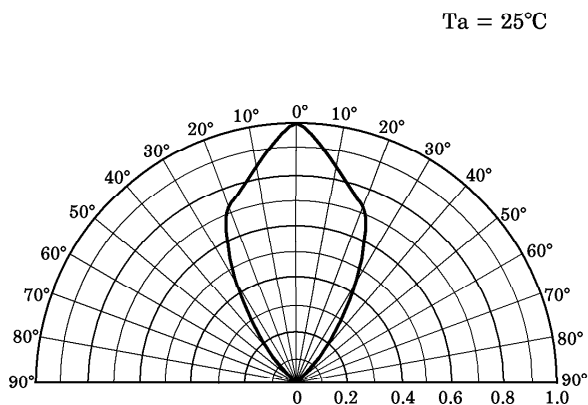

TLYU1102

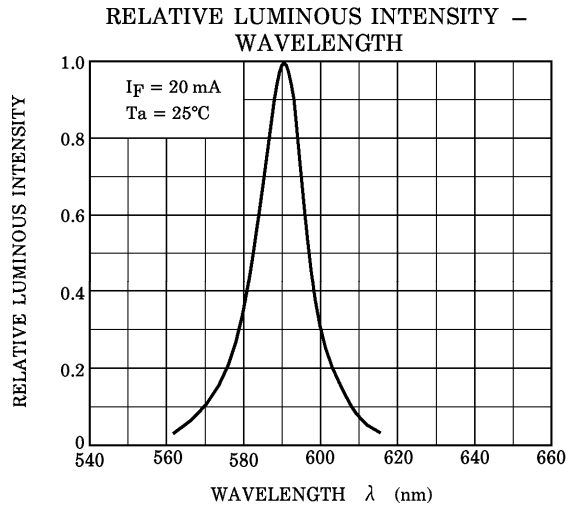
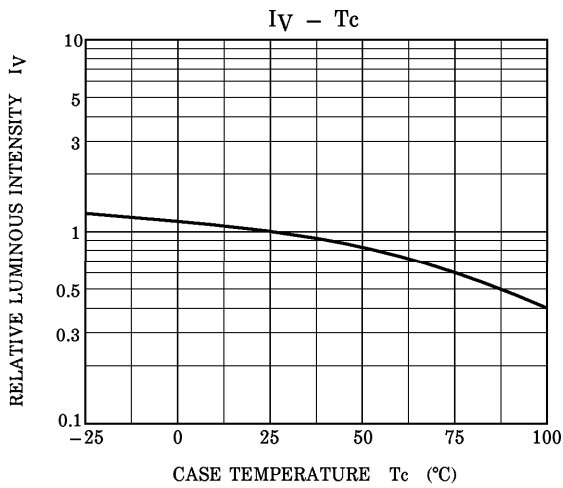
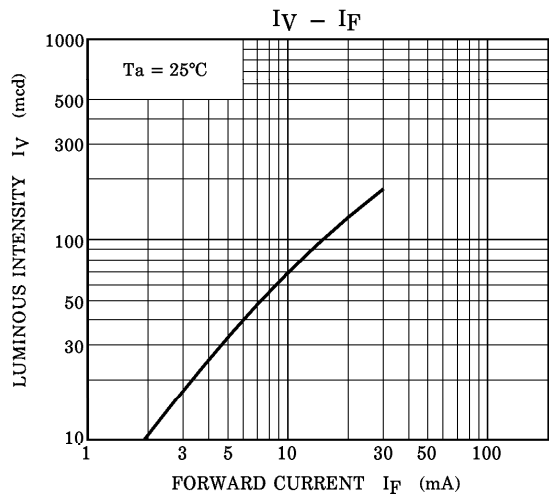
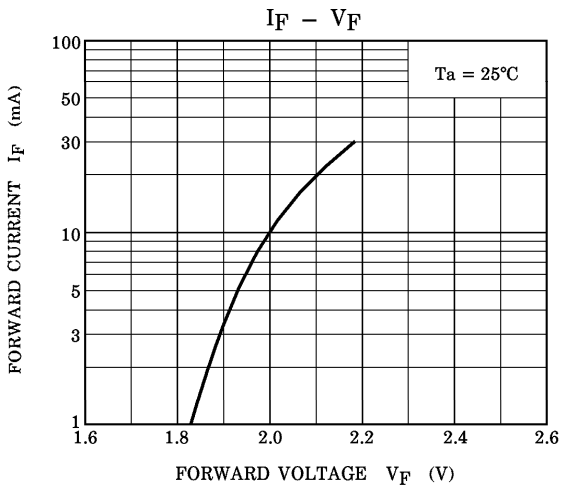

RADIATION PATTERN

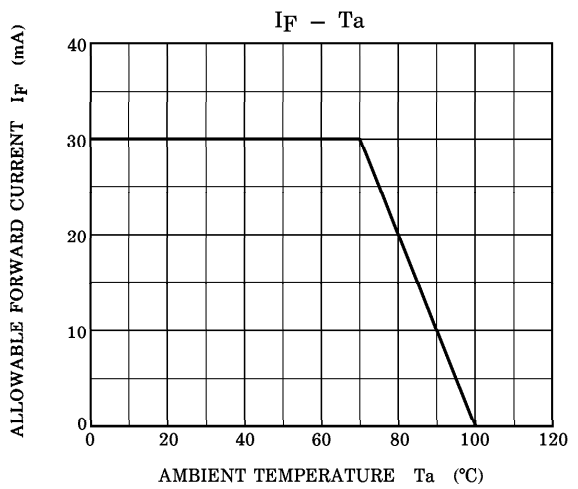
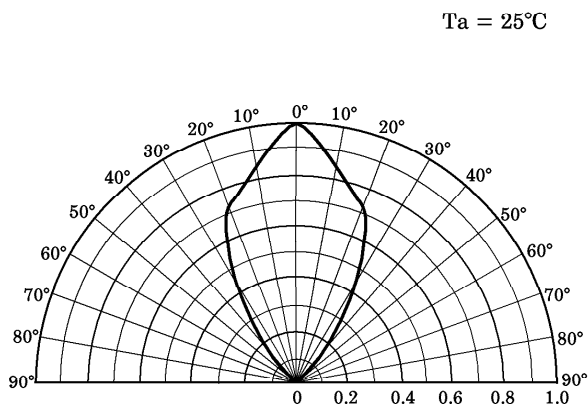

TLGU1102

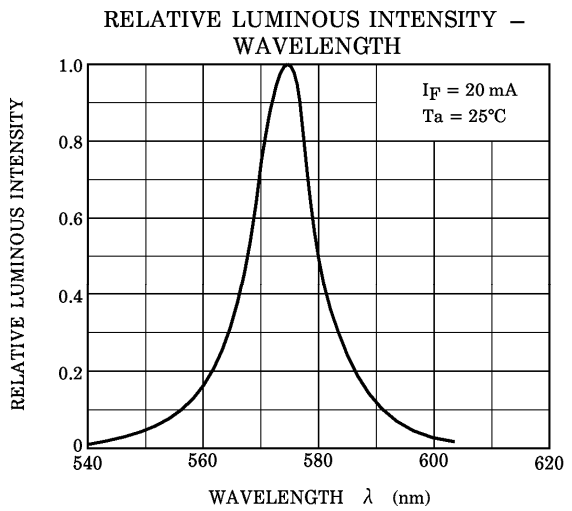
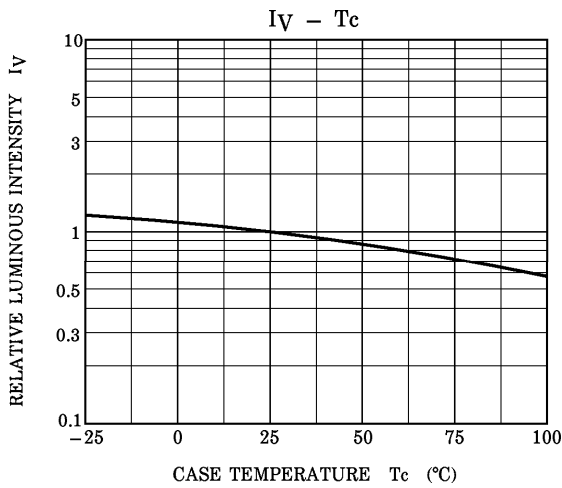
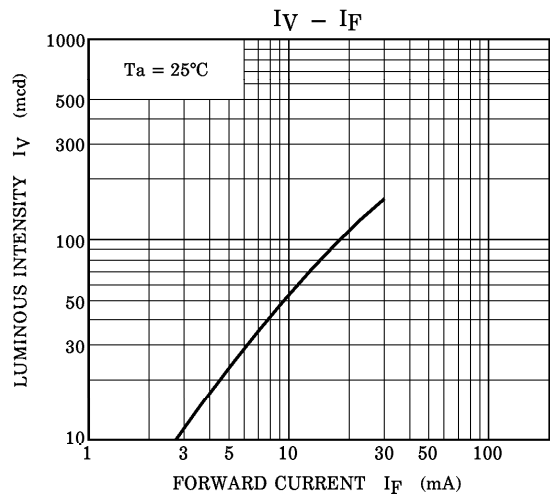
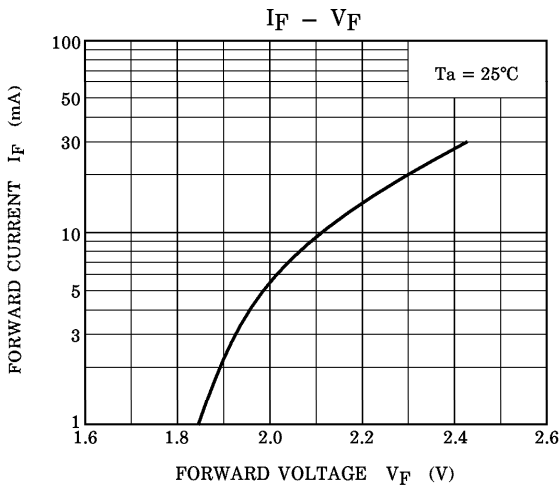

RADIATION PATTERN

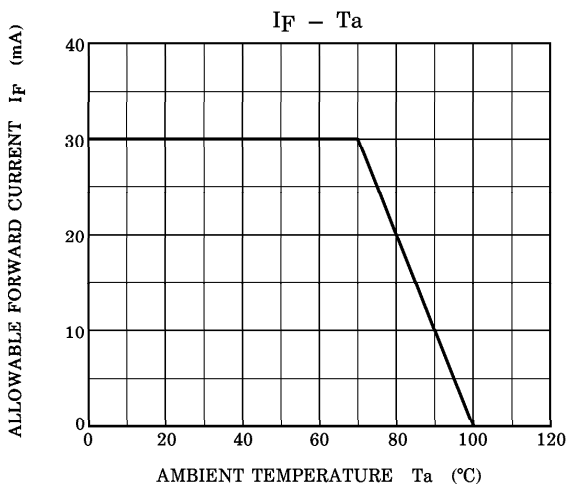
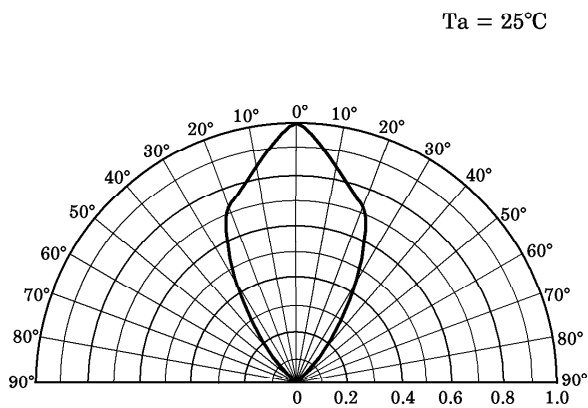

TLPGU1102

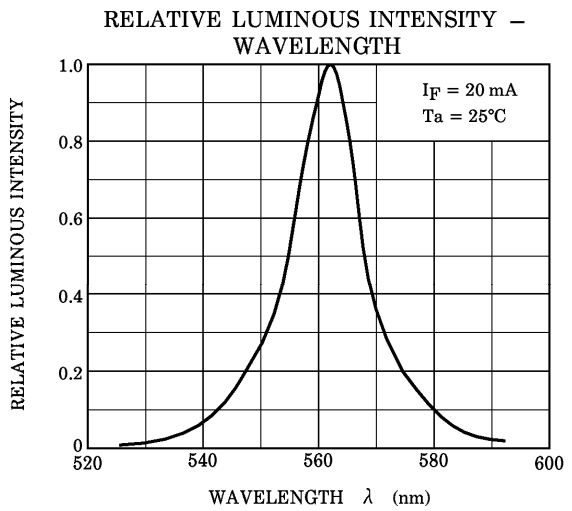
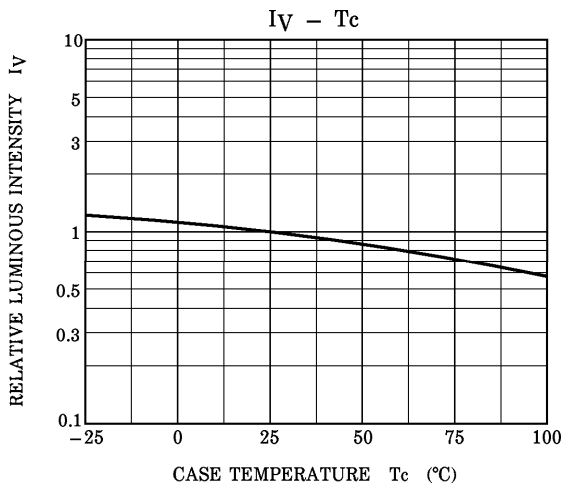
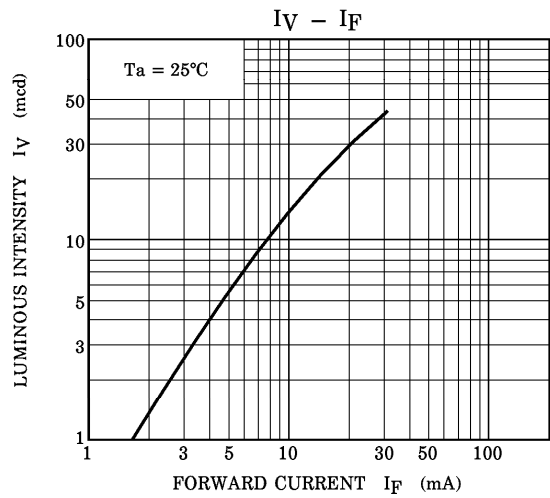
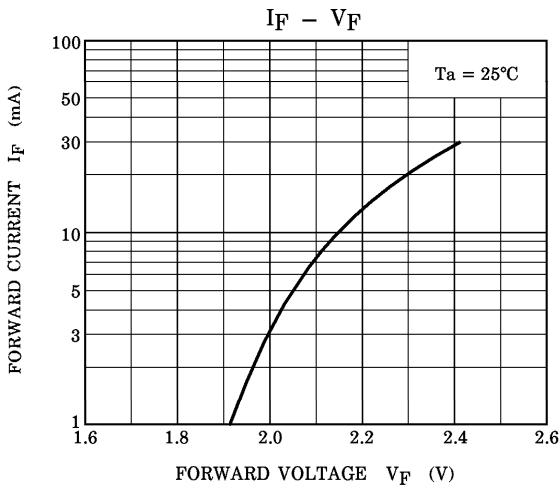

RADIATION PATTERN

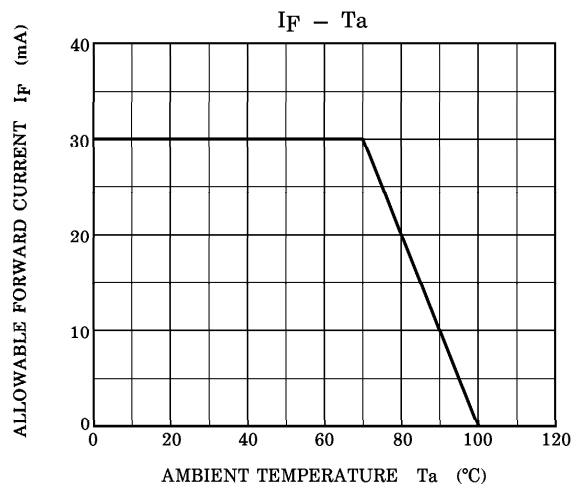
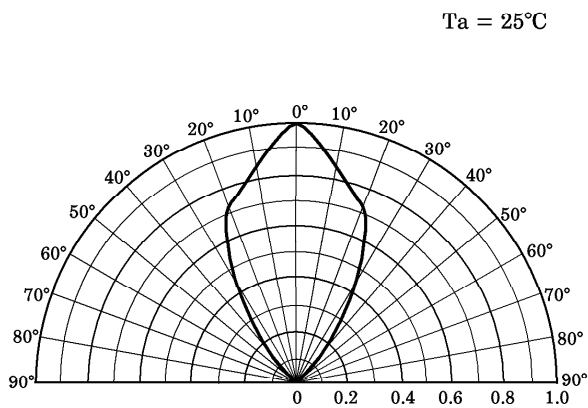

SOLDERING

Reflow soldering

Temperature profile

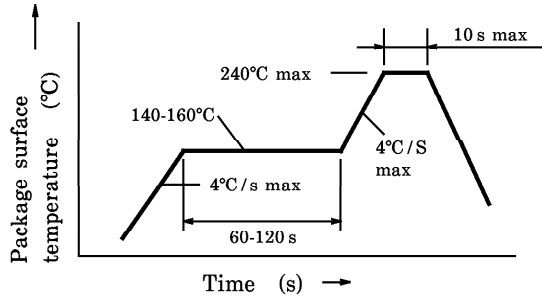

(*) Reflow is permitted just one time.

Recommended soldering pattern

(Unit in mm)

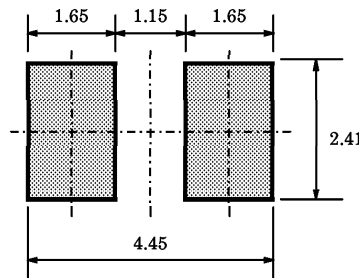

RECOMMENDATION FOR MANUAL SOLDERING

- Soldering iron : Less than 25 W
- Temperature : Lower than 300°C
- Time : Within 3 s

POST SOLDERING CLEANING

When cleaning after soldering is needed, the following condition must be adhered to.

- Cleaning solvents : AK225 or Alcohol
- Temperature : 50°C (max) for 30 s (max) or 30°C (max) for 3 minutes (max)
- Ultrasonic : 300 W max

PACKAGING

This LED device is packed in an aluminum envelope with silica-gel to avoid moisture absorption. The optical characteristics may be affected by exposure to moisture in the air before soldering and it should be stored under the following conditions.

Temperature : 5~30°C

Relative Humidity : 60% or lower

Baking is required if the device have been stored unopened for more than 6 month or if the aluminum envelope has been opened for more than 168 h.

Recommended baking condition is 60°C for 12 h minimum in the dry atmosphere.

PRECAUTION FOR MOUNTING

Do not apply force to the plastic part of the LED in high temperature conditions.

Do not apply friction using hard materials for avoid injuring the plastic part of the LED.

Keep the LED away from any other parts when assembling boards into the set.

TAPING SPECIFICATIONS

1. Taping Number

(1) Name : T10

(2) Example : TL□U1102 (T10)

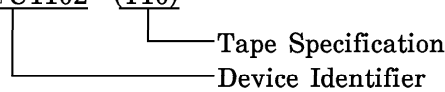

2. Dimension of tape

(Unit in mm)

ITEM	DIMENSIONS	TOLERANCE	ITEM	DIMENSIONS	TOLERANCE
D	1.5	+0.1/ -0	P ₂	2.0	±0.05
E	1.75	±0.1	W	12.0	±0.3
P ₀	4.0	±0.1	P	8.0	±0.1
t	0.3	±0.05	A ₀	2.9	±0.1
F	5.5	±0.05	B ₀	3.7	±0.1
D ₁	1.5	+0.1/ -0	K ₀	3.6	±0.1

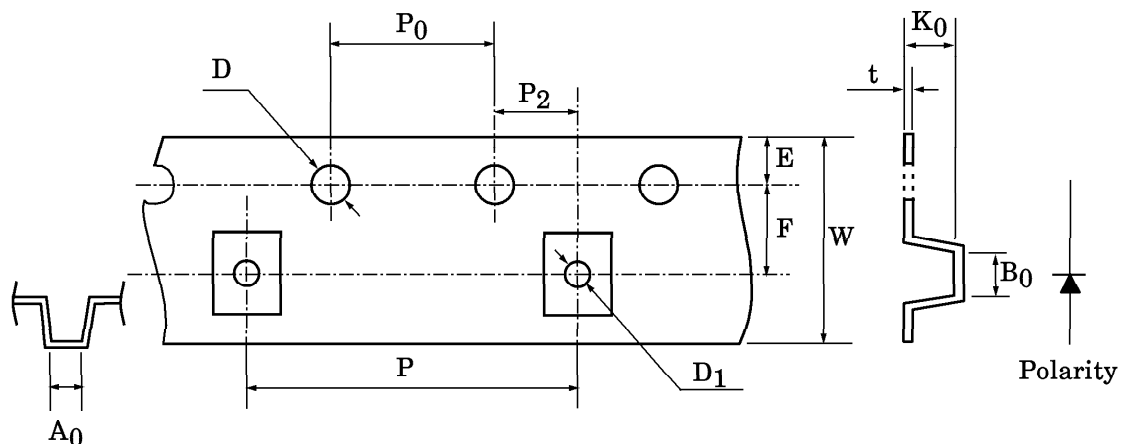

3. Dimension of reel

(Unit in mm)

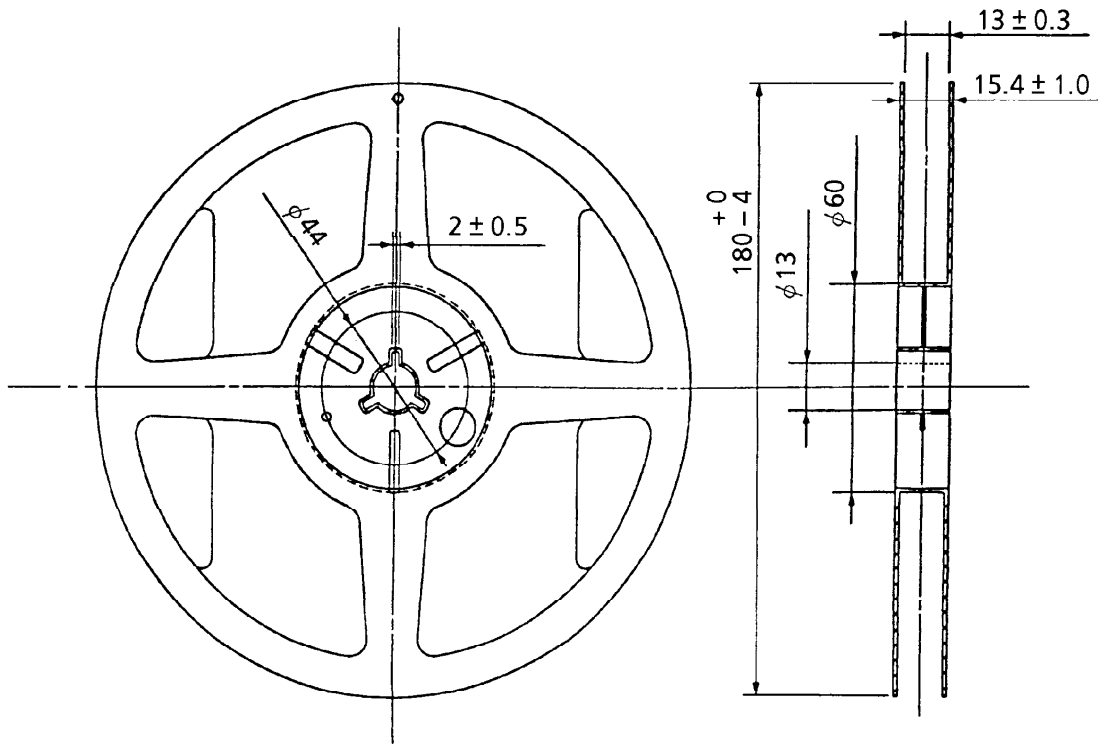

4. Leading part

(Unit in mm)

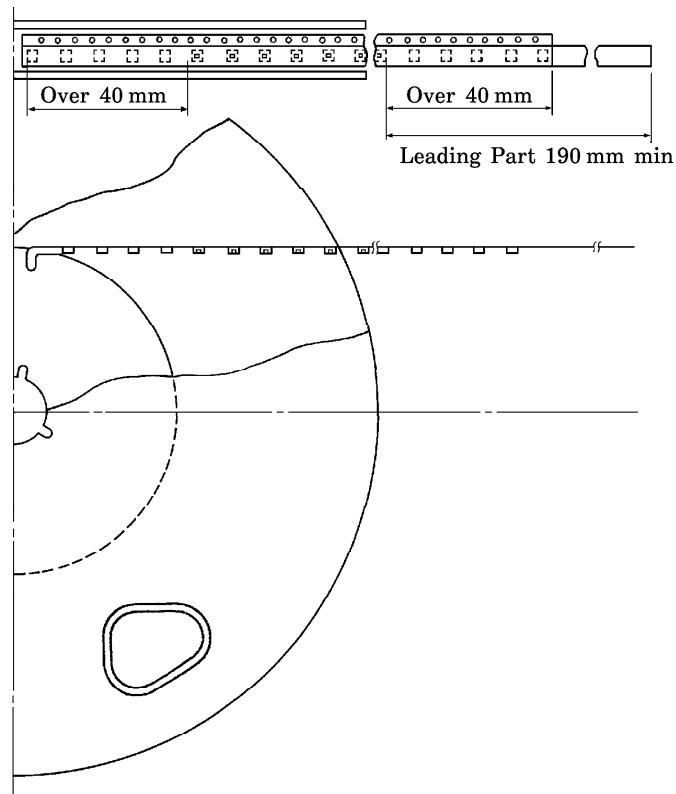

5. Packing Form

(1) Number of Devices per Reel and Carton

Reel	500 devices
Carton	2500 devices

(2) Packing : Silica gel and reel are packed into sealed aluminum pack.

6. Notation Method

(1) Example : TLSU1102 (T10)

P/N :

TYPE	TLSU1102		
ADD. C	(T10)	Q'TY	500 pcs
NOTE	(rank symbol)		Lot Number

(2) Label location :

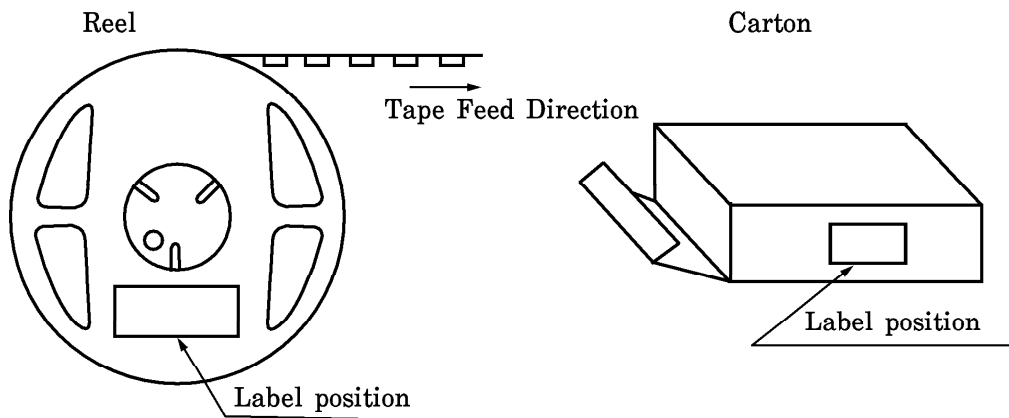

Aluminum pack : Attached to center of one side