

TeSys contactors

Model d contactors
Control circuit: a.c.

2

LC1-D09...D18 (3-pole)

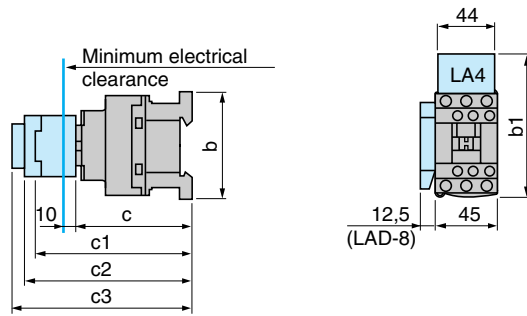

LC1-D25...D38 (3-pole)
LC1-DT20...DT60 (4-pole)

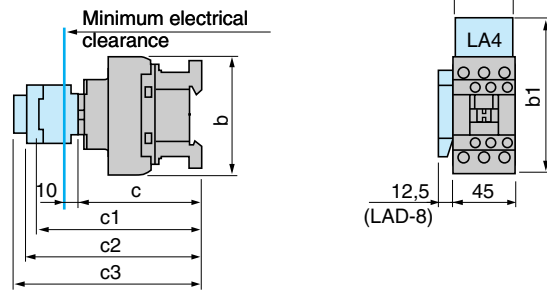

LC1-	D09... D18	D093... D183	D099... D189	D25... D38	D253 & D323	DT20 & DT25	DT203 & DT253	DT32... DT60	DT323 & DT603
b without add-on blocks	77	99	80	85	99	85	99	91	105
b1 with LAD-4BB	94	107	95.5	98	107	98	-	-	-
with LA4-D●2	110 (1)	123 (1)	111.5 (1)	114 (1)	123 (1)	114	-	-	-
with LA4-DF, DT	119 (1)	132 (1)	120.5 (1)	123 (1)	132 (1)	129	-	-	-
with LA4-DR, DW, DL	126 (1)	139 (1)	127.5 (1)	130 (1)	139 (1)	190	-	-	-
c without cover or add-on blocks	84	84	84	90	90	90	90	98	98
with cover, without add-on blocks	86	86	86	92	92	92	92	100	100
c1 with LAD-N or C (2 or 4 contacts)	117	117	117	123	123	123	123	131	131
c2 with LA6-DK10, LAD-6K10	129	129	129	135	135	135	135	143	143
c3 with LAD-T, R, S	137	137	137	143	143	143	143	151	151
with LAD-T, R, S and sealing cover	141	141	141	147	147	147	147	155	155

(1) Including LAD-4BB

LC1-D40...D65 (3-pole)

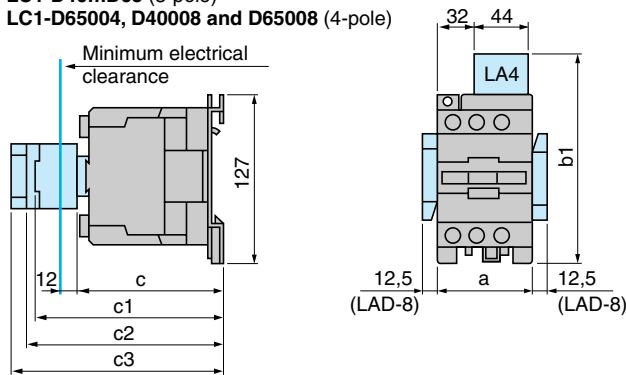

LC1-D80 and D95 (3-pole)

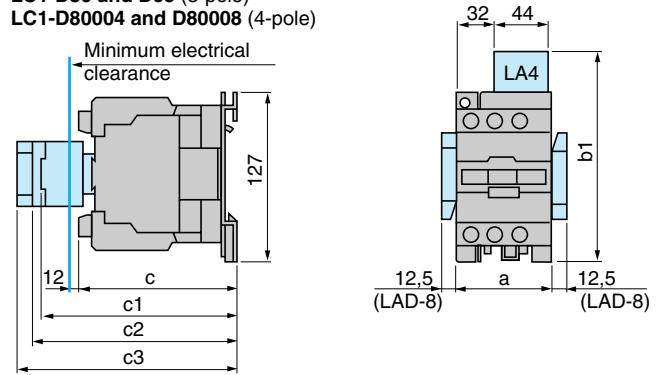

LC1-	D40...D65	D40008	D80 D65004	D95 D65008	D80004	D80008
a	75	85	85	85	96	96
b1 with LA4-D●2	135	135	135	135	135	135
with LA4-DB3	-	-	135	-	-	-
with LA4-DF, DT	142	142	142	142	142	142
with LA4-DM, DR, DW, DL	150	150	150	150	150	150
c without cover or add-on blocks	114	125	125	125	125	140
with cover, without add-on blocks	119	-	130	130	-	-
c1 with LAD-N (1 contact)	139	139	150	150	150	150
with LAD-N or C (2 or 4 contacts)	147	147	158	158	158	158
c2 with LA6-DK	159	159	170	170	170	170
c3 with LAD-T, R, S	167	167	178	178	178	178
with LAD-T, R, S and sealing cover	171	171	182	182	182	182

LC1-D115 and D150 (3-pole)

LC1-D115004 (4-pole)

LC1-	D115 D150	D115004	D115006	D150006	D1150046
a	120	150	120	120	155
b1 with LA4-DA2	174	174	174	174	174
with LA4-DF, DT	185	185	185	185	185
with LA4-DM, DR, DL	188	188	188	188	188
with LA4-DW	188	188	188	-	188
c without cover or add-on blocks	132	132	115	115	115
with cover, without add-on blocks	136	-	-	-	-
c1 with LAD-N or C (2 or 4 contacts)	150	150	150	150	150
c2 with LA6-DK20	155	155	155	155	155
c3 with LAD-T, R, S	168	168	168	168	168
with LAD-T, R, S and sealing cover	172	172	172	172	172

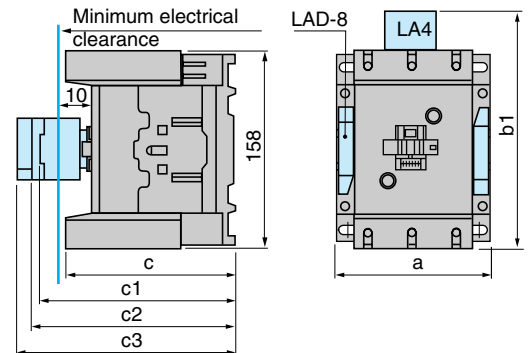

TeSys contactors

Model d contactors
Control circuit: d.c.
or low consumption

LC1-D09...D18 (3-pole)

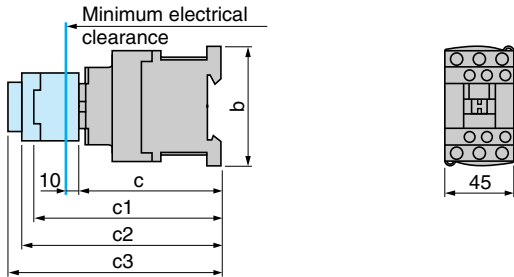

LC1-D25...D38 (3-pole)

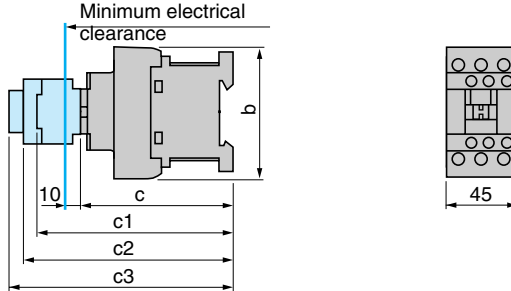

LC1-	D09...D18	D093...D183	D099...D189	D25...D38	D253 & D323
b	77	99	80	85	99
c without cover or add-on blocks	93	93	93	99	99
with cover, without add-on blocks	95	95	95	101	101
c1 with LAD-N or C (2 or 4 contacts)	126	126	126	132	132
c2 with LA6-DK10	138	138	138	144	144
c3 with LAD-T, R, S	146	146	146	152	152
with LAD-T, R, S and sealing cover	150	150	150	156	156

LC1-DT20 to DT60 (4-pole)

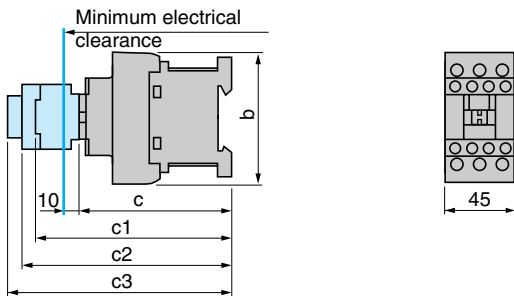

LC1-	DT20 & DT25 D098 & D128	DT203 & DT253 D0983 & D1283	DT32...DT60 D188...D328	DT323 & DT403 D1883 & D2583
b	85	99	91	105
c with cover	90	90	98	98
c1 with LAD-N or C (2 or 4 contacts)	123	123	131	131
c2 with LA6-DK10	135	135	143	143
c3 with LAD-T, R, S	143	143	151	151
with LAD-T, R, S and sealing cover	147	147	155	155

LC1-D40...D65 (3-pole)

LP1-D65004, LP1-D40008...D65008 (4-pole)

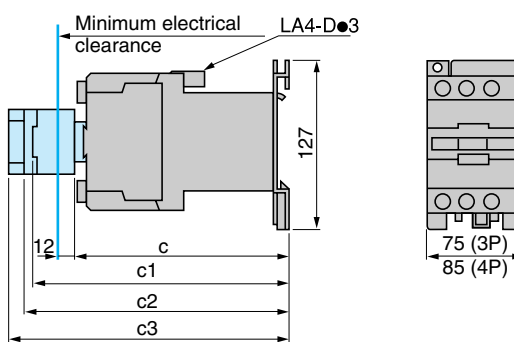

LC1-D80 and D95 (3-pole)

LP1-D80004, LP1-D80008 (4-pole)

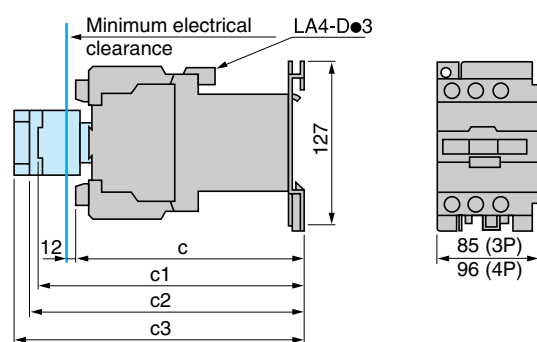

	LC1-D40...D65	LP1-D65004	LP1-D40008 & D65008	LC1-D80 & D95	LP1-D80004	LP1-D80008
c without cover or add-on blocks	171	171	182	181	181	196
with cover, without add-on blocks	176	-	-	186	-	-
c1 with LAD-N (1 contact)	196	196	196	204	204	204
with LAD-N or C (2 or 4 contacts)	202	202	202	210	210	210
c2 with LA6-DK10	213	213	213	221	221	221
c3 with LAD-T, R, S	221	221	221	229	229	229
with LAD-T, R, S and sealing cover	225	225	225	233	233	233

LC1-D115004: see page 2/94.

On mounting rail AM1-DP200, DR200 or AM1-DE200 (width 35 mm)
LC1-D09...D38, DT20...DT60

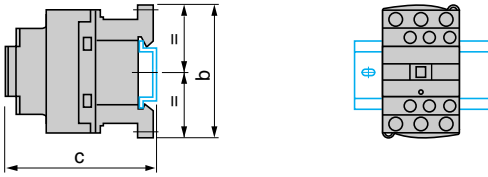

On mounting rail AM1-DL200 or DL201 (width 75 mm)
 On mounting rail AM1-ED●●● or AM1-DE200 (width 35 mm)
LC1-D40 to D95, LP1-D40 to D80

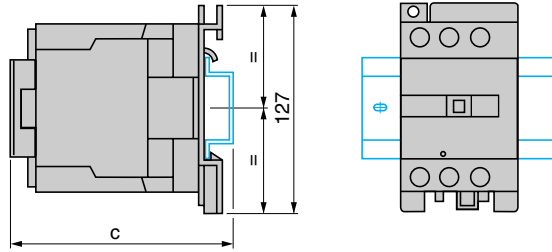

LC1-	D09...D18	D25...D38	DT20 & DT25	DT32... DT60
b	77	85	85	100
c (AM1-DP200 or DR200) (1)	88	94	94	109
c (AM1-DE200) (1)	96	102	102	117

d.c. control circuit

b	77	85	94	109
c (AM1-DP200 or DR200) (1)	97	103	103	118
c (AM1-DE200) (1)	105	110	111	1236

a.c. control circuit

LC1-	D40...D65	D80 & D95
c (AM1-DL200) (1)	136	147
c (AM1-DL201) (1)	126	137
c (AM1-ED●●● or DE200) (1)	126	137

d.c. control circuit

LC1-	D40...D65	D80 & D95
c (AM1-DL200) (1)	193	203
c (AM1-DL201) (1)	183	203

LP1-	D40	D65	D80
c (AM1-DL200)	188	188	198
c (AM1-DL201)	178	178	198

(1) with safety cover

On 2 mounting rails DZ5-MB at 120 mm centres
LC1-D115, D150

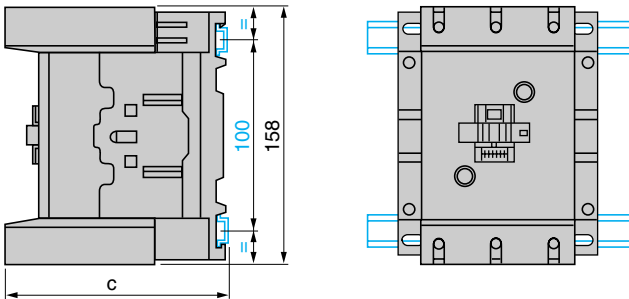

(1) with safety cover

a.c. or d.c. control circuit

LC1-	D115 & D150	D1156 & D1506
c (AM1-DP200 or DR200)	134.5	117.5
c (AM1-DE200 or ED●●●)	142.5	125.5

On 2 mounting rails DZ5-MB at 120 mm centres
LC1-D40...D95, LP1-D40...D80

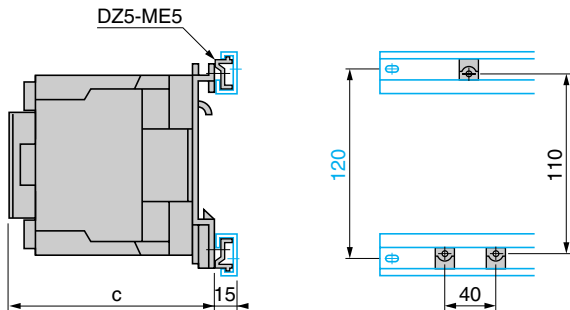

a.c. control circuit

LC1-	D40...D65	D80 & D95
c with cover	119	130

d.c. control circuit

LC1-	D40...D65	D80 & D95
c with cover	176	186
LP1-	D40 & D65	D80
c	171	181

LC1-D09 to D38 and LC1-DT20...DT60

On 2 mounting rails DZ5-MB

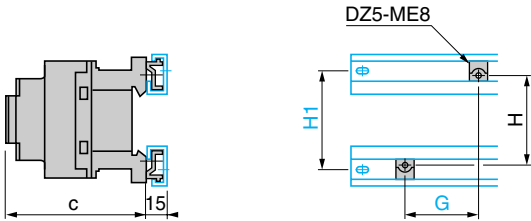

Control circuit:	a.c.		d.c.	
LC1-	D09...D18	D25...D38	D09...D18	D25...D38
c with cover	86	92	95	101
G	35	35	35	35
H	60	60	60	60
H1	70	70	70	70

4-pole contactors				
LC1-	DT20 & DT25	DT32 ...DT60	DT20 & DT25	DT32 ...DT60
c	92	100	101	109
G	135	40/50	35	35
H	60	60	60	60
H1	70	70	70	70

LC1-D09...D38 and LC1-DT20...DT60

On pre-slotted mounting plate AM1-PA, PB, PC



Control circuit:	a.c.		d.c.	
LC1-	D09...D18	D25...D38	D09...D18	D25...D38
c with cover	86	92	95	101
G	35	35	35	35
c with cover	86	92	95	101

4-pole contactors				
LC1-	DT20 & DT25	DT32 ...DT60	DT20 & DT25	DT32 ...DT60
c	80	93	118	132
G	35	35	35	35
H	60	60	60	60

LC1-D40...D95, LP1-D40...D80

On pre-slotted mounting plate AM1-PA, PB, PC

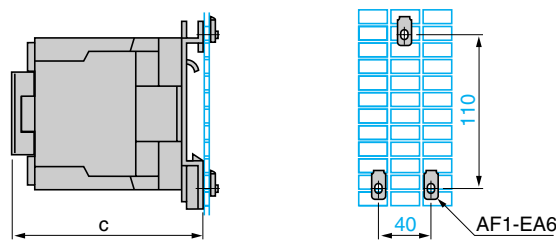

Control circuit:	a.c.		d.c.	
LC1-	D40...D65	D80 & D95	D40...D65	D80 & D95
c with cover	119	130	176	186
LP1-	-	-	D40 & D65	D80
c without cover	-	-	171	181

LC1-D09...D38

Panel mounted

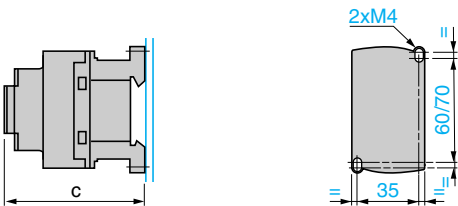

Control circuit:	a.c.		d.c.	
LC1-	D09...D18	D25...D38	D09...D18	D25...D38
c with cover	86	92	95	101

4-pole contactors				
LC1-	DT20 & DT25	DT32 ...DT60	DT20 & DT25	DT32 ...DT60
c with cover	90	98	90	98

LC1-D40...D95, LP1-D40 to D80

Panel mounted

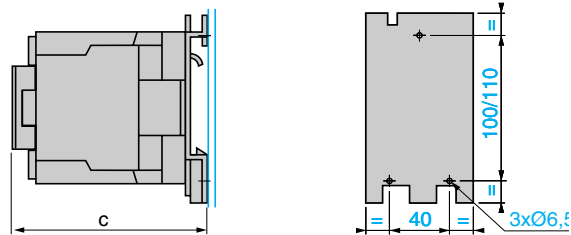

Control circuit:	a.c.		d.c.	
LC1-	D40...D65	D80 & D95	D4...D65	D80 & D95
c with cover	119	130	176	186
LP1-	-	-	D40 & D65	D80
c without cover	-	-	171	181

LC1-D115, D150

Panel mounted

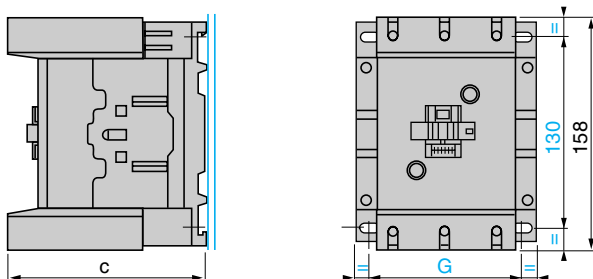

LC1-	D115	D1156	D150	D1506
c	132	115	132	115
G (3-pole)	96/110	96/110	96/110	96/110
G (4-pole)	130/144	130/144	-	-

3-pole contactors (References: pages 2/74 to 2/77)

LC1-D09 to D150

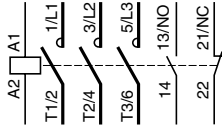

4-pole contactors (References: pages 2/76 and 2/77)

LC1 and LP1-
D12004 to D80004
LC1-D115004

LC1 and LP1-
D12008 to D25008

LC1 and LP1-
D40008 to D80008

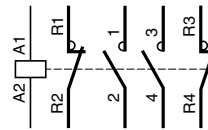
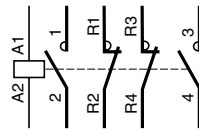
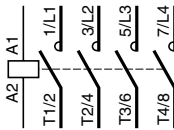

Front mounting add-on contact blocks

Instantaneous auxiliary contacts (References: page 2/85)

1 N/O LAD-N10 (1)

1 N/C LAD-N01 (1)

1 N/O + 1 N/C LAD-N11

2 N/O LAD-N20

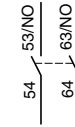
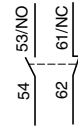
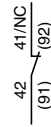
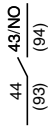

2 N/C LAD-N02

2 N/O + 2 N/C LAD-N22

1 N/O + 3 N/C LAD-N13

4 N/O LAD-N40

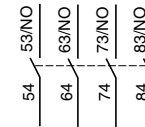
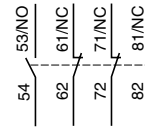
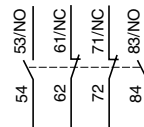
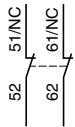

4 N/C LAD-N04

2 N/O + 2 N/C including 1 N/O + 1 N/C make before break LAD-C22

3 N/O + 1 N/C LAD-N31

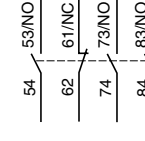
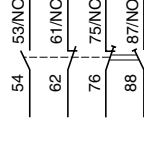
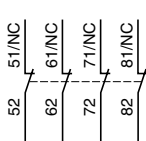

Front mounting add-on contact blocks

Instantaneous auxiliary contacts conforming to standard EN 50012 (References: page 2/85)

1 N/O + 1 N/C LAD-N11G

1 N/O + 1 N/C LAD-N11P

2 N/O + 2 N/C LAD-N22G

2 N/O + 2 N/C LAD-N22P

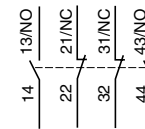
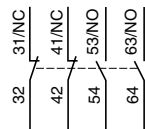
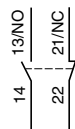
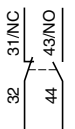

(1) Items in brackets are for blocks mounted on right-hand side of contactor.

Front mounting add-on contact blocks

Dust and damp protected instantaneous auxiliary contacts (References: page 2/85)
 2 N/O (24-50 V) LA1-DX20 2 N/C (24-50 V) LA1-DX02 2 N/O (5-24 V) LA1-DY20

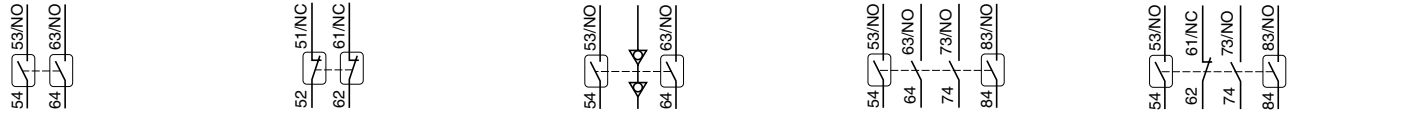

Front mounting add-on contact blocks

Time-delay auxiliary contacts (References: page 2/86)
 On-delay 1 N/O + 1 N/C LAD-T Off-delay 1 N/O + 1 N/C LAD-R On-delay N/C with 1 N/O break before make LAD-S

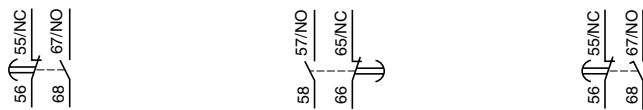

Mechanical latch blocks

(References: page 2/86)
 LA6-DK10 and LA6-DK20

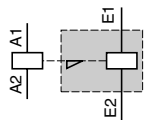

Side mounting add-on contact blocks

Instantaneous auxiliary contacts (References: page 2/85)
 1 N/O + 1 N/C LAD-8N11 (1) 2 N/O LAD-8N20 (1) 2 N/C LAD-8N02 (1)

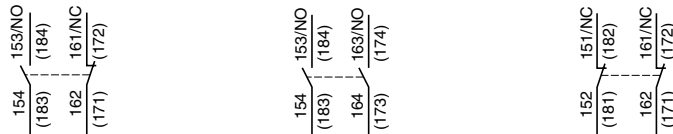

(1) Items in brackets are for blocks mounted on right-hand side of contactor.

Electronic serial timer modules

On-delay LA4-DT●U

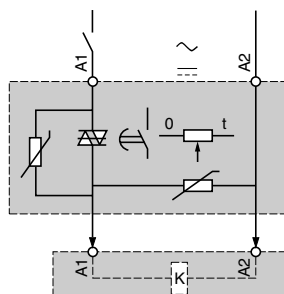

Off-delay LA4-DR●U

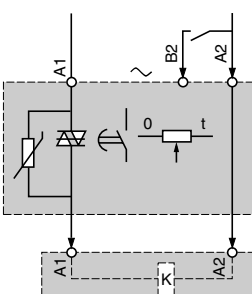

Auto-Man-Stop modules

LA4-DM●

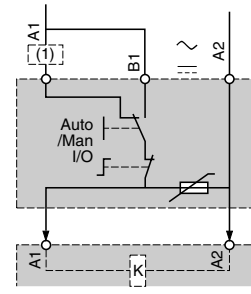

(1) PLC

Interface modules

Relay interface LA4-DF●

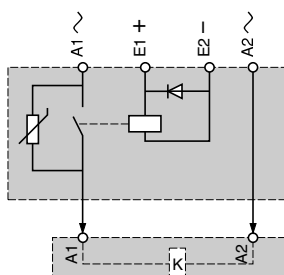

LA4-DFBQ

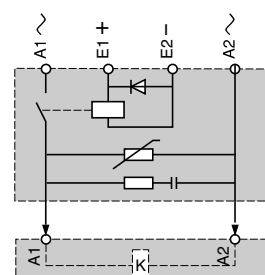

Relay interface with override switch LA4-DL●

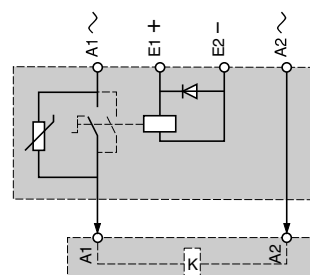

Solid state LA4-DWB●

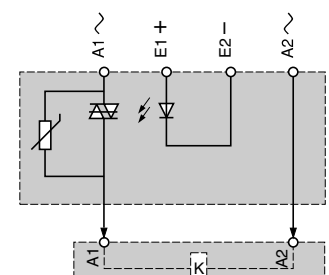

(Reference: page 2/89)

2

LC2-D09 to D38
2 x LC1-D09 to D38

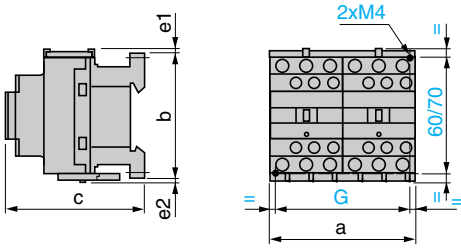

LC2-DT20 to DT60
2 x LC1-DT20 to DT60

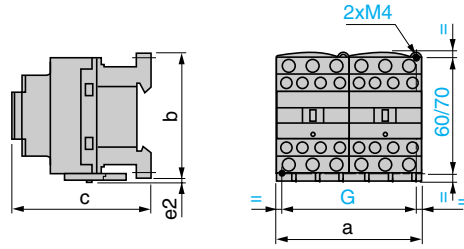

LC2- or 2 x LC1-	a	b	c (1)	e1	e2	G
D09 to D18 ~	90	77	86	4	1.5	80
D093 to D183 ~	90	99	86	-	-	80
D09 to D18 ...	90	77	95	4	1.5	80
D093 to D183 ...	90	99	95	-	-	80
D12004	-	74	80	-	6	95
D25 to D38 ~	90	85	92	9	5	80
D253 to D383 ~	90	99	92	-	-	80
D25 to D32 ...	90	85	101	9	5	80
D253 to D383 ...	90	99	101	-	-	80
D25004	-	84	93	-	7	111

LC2- or 2 x LC1-	a	b	c	G
DT20 and DT25	90	85	90	80
DT32...DT60	90	91	98	80

e1 and e2: including cabling.
(1) With safety cover, without add-on block.

c, e: including cabling.

2.3

LC2-D40 to D65
2 x LC1-D40 to D65

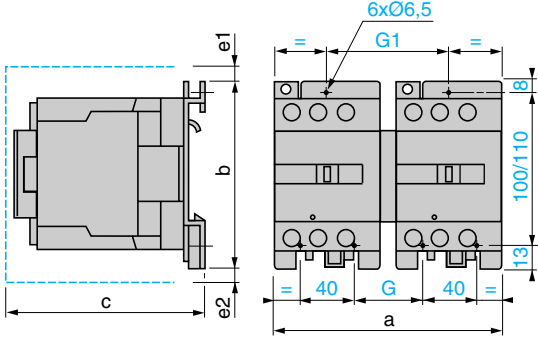

2 x LP1-D40 and D65

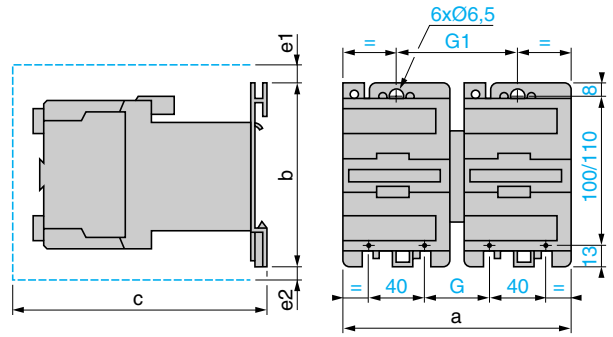

LC2- or 2 x LC1-	a	b	c	e1	e2	G	G1
D40 to D65	165	127	142	5	-	50	90
D40004	182	127	133	-	11	57	97
D65004	182	127	133	-	11	57	97
D80 and D95	182	127	158	13	-	57	96
D80004	207	127	158	-	20	71	111

LC2- or 2 x LC1-	a	b	c	e1	e2	G	G1
D40 to D65	182	127	190	5	11	57	97
D80 and D95	207	127	215	13	20	96	111

c, e1 and e2: including cabling.

c, e1 and e2: including cabling.

LC2-D115 and D150
2 x LC1-D115 and D150

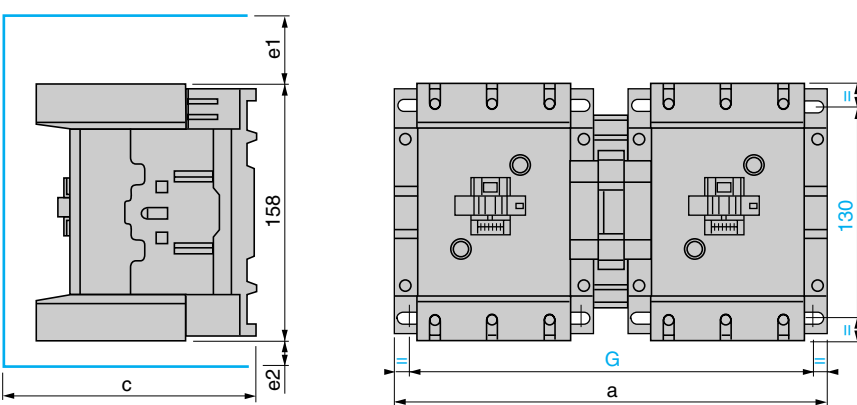

LC2- or 2 x LC1-	a	c	e1	e2	G
D115, D150	266	148	56	18	242/256
D115004	334	148	-	60	310/324

c, e1 and e2: including cabling.

Reversing contactors for motor control, horizontally mounted
LC2-D09...D150

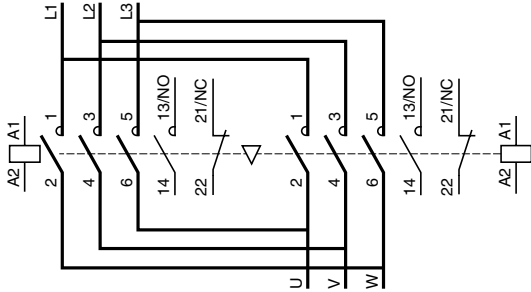

Reversing contactors for motor control with integral electrical interlocking (LAD-9R1V)

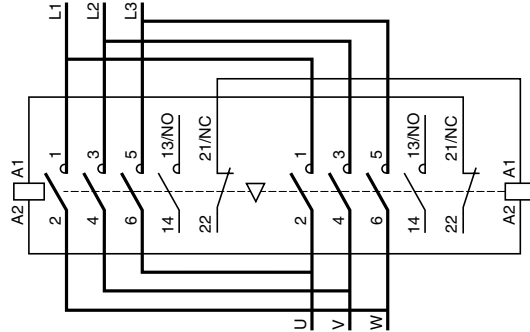

Changeover contactor pairs, horizontally mounted
LC2-DT20...DT60

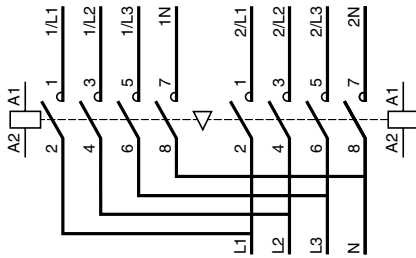

Electrical interlocking of reversing contactors fitted with:
mechanical interlock with integral electrical contacts
LA9-D●●●02

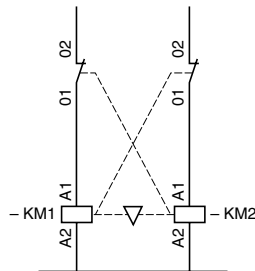
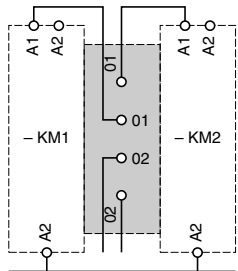

mechanical interlock without integral electrical contacts
LA9-D●●●78, LAD-9R1

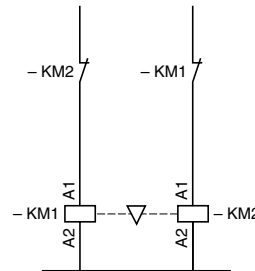

Low speed - High speed cabling kit

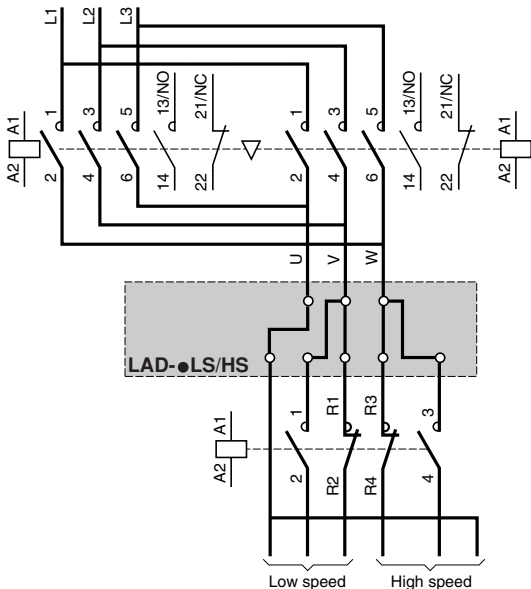

2

2.3