

## Solid-state Timer

## H3CR-A

### DIN 48 x 48-mm Multifunctional Timer with Many Time Ranges, Operating Modes and Wide Power Supply Ranges

A wide power supply range (100 to 240 VAC) and (24 VAC/DC) reduces the number of timer models kept in stock.

Handles a wide range of applications through six operating modes.

Only 80 mm long when panel-mounted with a Socket (excluding H3CR-A8EL).

Setting rings (order separately) to enable consistent settings and to limit the setting range.

Panel Covers (order separately) to enable various panel designs.

All Units offer a wide time range (0.05 s to 300 h).

H3CR-A8EL can be used to replace:  
 STPNH using Y92F-42 adaptor  
 STPYMH using Y92F-70 adaptor

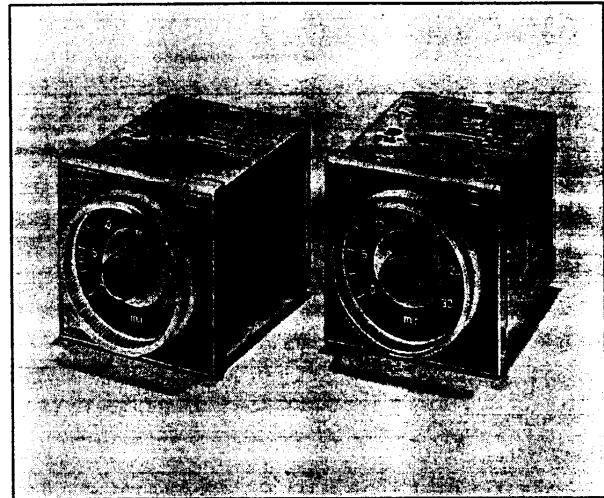

### Ordering Information

Outputs	Supply voltage	11-pin models	8-pin models
Contact	100 to 240 VAC (50/60 Hz)	H3CR-A	H3CR-A8
	24 VDC/VAC (50/60 Hz)		
Time-limit contact and instantaneous contact	100 to 240 VAC (50/60 Hz)	---	H3CR-A8EL
	24 VDC/VAC (50/60 Hz)		H3CR-A8E

**Note:** Specify both the model number and supply voltage when ordering.  
 Example: H3CR-A 100 to 240 VAC

Supply voltage

#### ■ Accessories (Order separately)

Socket	8-pin	11-pin
Track Mounting/ Front Connecting Socket	P2CF-08	P2CF-11
Back Connecting Socket	P3G-08	P3GA-11

Flush Mounting Adaptor	Y92F-30
Protective Cover	Y92A-48B
IP66 Protective Cover	Y92A-48N

#### Time Setting Ring

Setting a specific time	Y92S-27
Limiting the Setting Range	Y92S-28

#### Panel Cover

Colour (Munsell No.)	Model
Light Grey (5Y7/1)	Y92P-48GL
Black (N1.5)	Y92P-48GB
Medium Grey (5Y5/1)	Y92P-48GM

**Note:** The Time Setting Ring and Panel Cover are sold together.

### Specifications

#### ■ General

Item	H3CR-A	H3CR-A8	H3CR-A8EL/A8E
Operating mode	A: ON-delay B: Flicker OFF start B2: Flicker ON start C: Signal ON/OFF-delay D: Signal OFF-delay E: Interval	A: ON-delay E: Interval	
Pin type	11-pin	8-pin	
Input type	No-voltage input	---	
Time-limit output type	H3CR-A/-A8: Relay output (DPDT)		Relay output (SPDT)
Instantaneous output type	---		Relay output (SPDT)

Item	H3CR-A	H3CR-A8	H3CR-A8EL/A8E
Mounting method	DIN track mounting, surface mounting, and flush mounting		
Approved standards	UL508, CSA C22.2 No.14, LR/NK		

Note: The internal circuits are optically isolated from the output. This enables application of either NPN or PNP transistors.

### ■ Time Ranges

Time unit	s (sec)	min	h (hrs)	x10 h (10 h)
Setting	0	Instantaneous output (To obtain instantaneous output, set to below 0.) (see note)		
	1.2	0.05 to 1.2	0.12 to 1.2	1.2 to 12
	3	0.3 to 3		3 to 30
	12	1.2 to 12		12 to 120
	30	3 to 30		30 to 300

Note: Instantaneous output is available with all H3CR-A models.

### ■ Ratings

Rated supply voltage	100 to 240 VAC (50/60 Hz), 24 VDC/VAC (50/60 Hz)
Operating voltage range	85% to 110% of rated supply voltage
Power reset	Minimum power-opening time: 0.1 s
No-voltage input	ON impedance: 1 k $\Omega$ max. ON residual voltage: 1 V max. OFF impedance: 100 k $\Omega$ min.
Power consumption	100 to 240 VAC: approx. 10 VA 24 VDC/VAC: approx. 2 VA (AC), approx. 1 W (DC)
Control outputs	Time limit contacts: 5 A at 250 VAC, resistance load (cos $\phi$ = 1) Instantaneous contact: 5 A at 250 VAC, resistance load (cos $\phi$ = 1)

### ■ Characteristics

Accuracy of operating time	+0.3% FS max. (+0.3%+10 ms in a range of 1.2 s)
Setting error	+5% FS +0.05 s max.
Reset time	Min. power-opening time: 0.1 s max. Min. pulse width: 0.05 s (H3CR-A/-AS)
Influence of voltage	+0.5% FS max. (+0.5%+10 ms in a range of 1.2 s)
Influence of temperature	+2% FS max. (+2%+10 ms in a range of 1.2 s)
Insulation resistance	100 M $\Omega$ min. (at 500 VDC)
Dielectric strength	2,000 VAC, 50/60 Hz for 1 min (between current-carrying metal parts and exposed non-current-carrying metal parts) 2,000 VAC, 50/60 Hz for 1 min (between control output terminals and operating circuit) 1,000 VAC, 50/60 Hz for 1 min (between contacts not located next to each other)
Impulse withstand voltage	3 kV (between power terminals) for 100 to 240 VAC, 48 to 125 VDC, 1 kV for 12 VDC, 24 VDC/VAC 4.5 kV (between current-carrying terminal and exposed non-current-carrying metal parts) for 100 to 240 VAC, 48 to 125 VDC, 1.5 kV for 12 VDC, 24 VDC/VAC
Noise immunity	+1.5 kV (between power terminals) and +600 V (between input terminals), square-wave noise by noise simulator (pulse width: 100 ns/1 $\mu$ s, 1-ns rise)
Static immunity	Malfunction: 8 kV Destruction: 15 kV
Vibration resistance	Destruction: 10 to 55 Hz with 0.75-mm double amplitude each in three directions Malfunction: 10 to 55 Hz with 0.5-mm double amplitude each in three directions
Shock resistance	Destruction: 1,000 m/s <sup>2</sup> (Approx. 100G) each in three directions Malfunction: 100 m/s <sup>2</sup> (Approx. 10G) each in three directions
Ambient temperature	Operating: -10°C to 55°C (with no icing) Storage: -25°C to 65°C (with no icing)
Ambient humidity	Operating: 35% to 85%
Life expectancy	Mechanical: 20,000,000 operations min. (under no load at 1,800 operations/h) Electrical: 100,000 operations min. (5 A at 250 VAC, resistive load at 1,800 operations/h)
Case colour	Light Grey (Munsell 5Y7/1)
Degree of protection	IEC: IP40
Weight	H3CR-A: approx. 90 g; H3CR-A8E/-A8EL: approx. 110 g

## Engineering Data

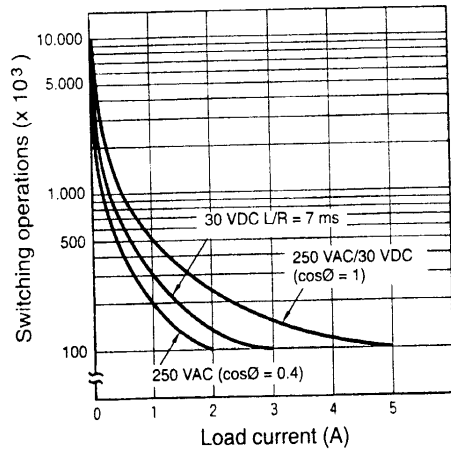

Reference: A maximum current of 0.15 A can be switched at 125 VDC (cosØ = 1) and a maximum current of 0.1 A can be switched if L/R is 7 ms. In both cases, a life of 100,000 operations can be expected. The minimum applicable load is 10 mA at 5 VDC (failure level: P).

## Nomenclature

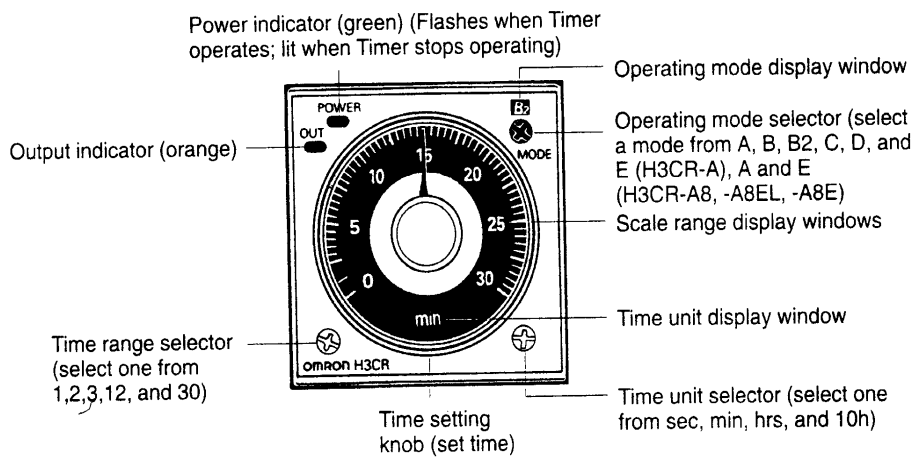

## Operation

### I/O Functions

Inputs (for -A)	Start	Starts time-measurement.
	Reset	Interrupts time-measurement and resets time-measurement value. No time-measurement is made and control output is OFF while the reset input is ON.
	Gate	Prohibits time-measurement.
Outputs	Control output	Outputs are turned ON according to designated output mode when preset value is reached.

### Basic Setting

#### Setting of Selector

The selectors can be turned clockwise and counterclockwise to select the desired time unit, time range, or operating mode. Each selector has a snap mechanism that secures the selector at a given position. Set the selector at a position at which it is secured. Do not set it midway between two securing positions or a malfunction could result from improper setting.

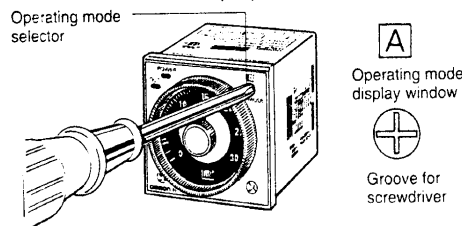

#### Selection of Operating Mode

Turn the operating mode selector with a screwdriver until the desired operating mode (A, B, B2, C, D, or E) appears in the display window located above the selector.

#### Selection of Time Unit and Time Range

The desired time unit (sec, min, hrs, or 10h) is displayed in the window below the time setting knob by turning the time unit selector lo-

cated at the lower right corner of the front panel. A time range (1.2, 3, 12, or 30) is selected with the time range selector at the lower left corner of the front panel, and the selected time range appears (in the window at the lower right part) within the plastic frame of the time setting knob.

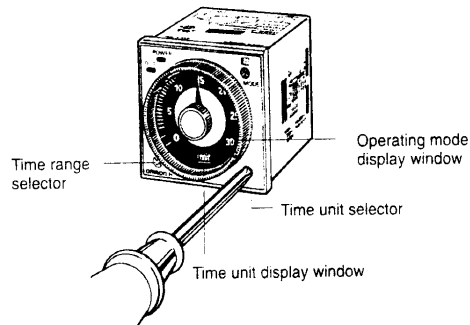

#### Setting of Time

Use the time setting knob to set the desired time.

### ■ Using the Setting Ring

#### Setting a Specific Time

Mount the Panel Cover on the Timer, set the desired time with the time setting knob, and place Time Setting Ring A onto the time set-

ting knob so that the time setting notch of Time Setting Ring A is in the centre of the reset lock position of the Panel Cover.

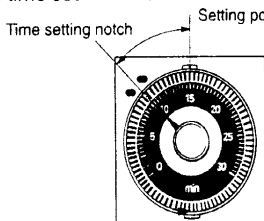
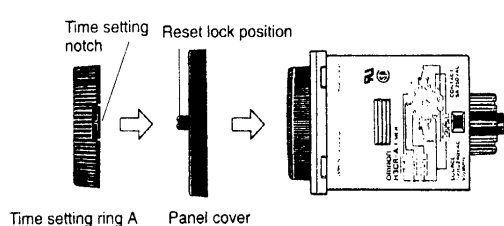

Example: To set the time to 10 s.

#### Limiting the Setting Range

Example: To set a range of 10 and 20 s.

Mount the Panel Cover on the Timer, set the time setting knob to 10 s (the lower limit of the setting range), and place Time Setting Ring C onto the time setting knob so that the stopper of Time Setting Ring C is on the right edge of the reset lock position of the Panel cover.

er. Next, set the time setting knob to 20 s (the upper limit of the setting range), place Time Setting Ring B onto the time setting knob so that the stopper of Time Setting Ring B is on the left edge of the reset lock position of the Panel Cover.

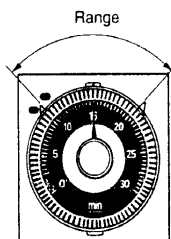
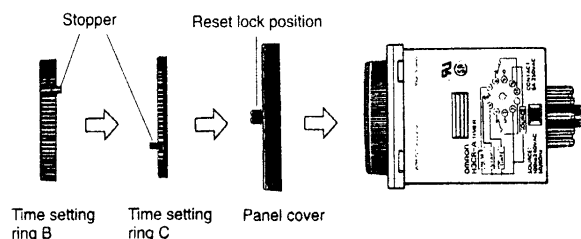

#### Time Setting Ring/Panel Cover

There are three types of Panel Covers (Y92P-48GL, Y92P-48GB, and Y92P-48GM), all of which are available in three colors. Use the most suitable type of Panel Cover with the design of the scaling plate according to the application.

When setting a given time for the Timer, use of the Y92S-27 or Y92S-28 Time Setting Ring facilitates the time setting operation and minimizes possible setting errors by operators.

The Time Setting Ring and Panel Cover should be used as a pair.

<b>Setting a specific time</b>	Time Setting Ring A (Y92S-27) and Panel Cover (Y92P-48GL, -48GB, or -48GM)
<b>Limiting the setting range</b>	Time Setting Ring B or C (Y92S-28), and Panel Cover (Y92P-48GL, -48GB, or -48GA)

Y92S-27 Time Setting A



Y92S-28 Time Setting B



Y92S-28 Time Setting C



Y92P-48GL Light Gray

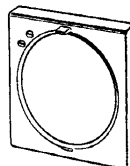

Y92P-48GB Black

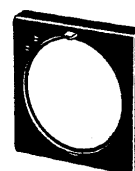

Y92P-48GM Medium Gray

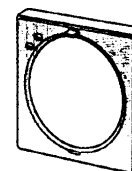

■ Timing Chart

Note: 1. The minimum power-on time ("Rt") is 0.1 s and the minimum pulse width is 0.05 s.

2. The letter "t" in the timing charts stands for the set time and "t-a" means that the period is less than the time set.

H3CR-A

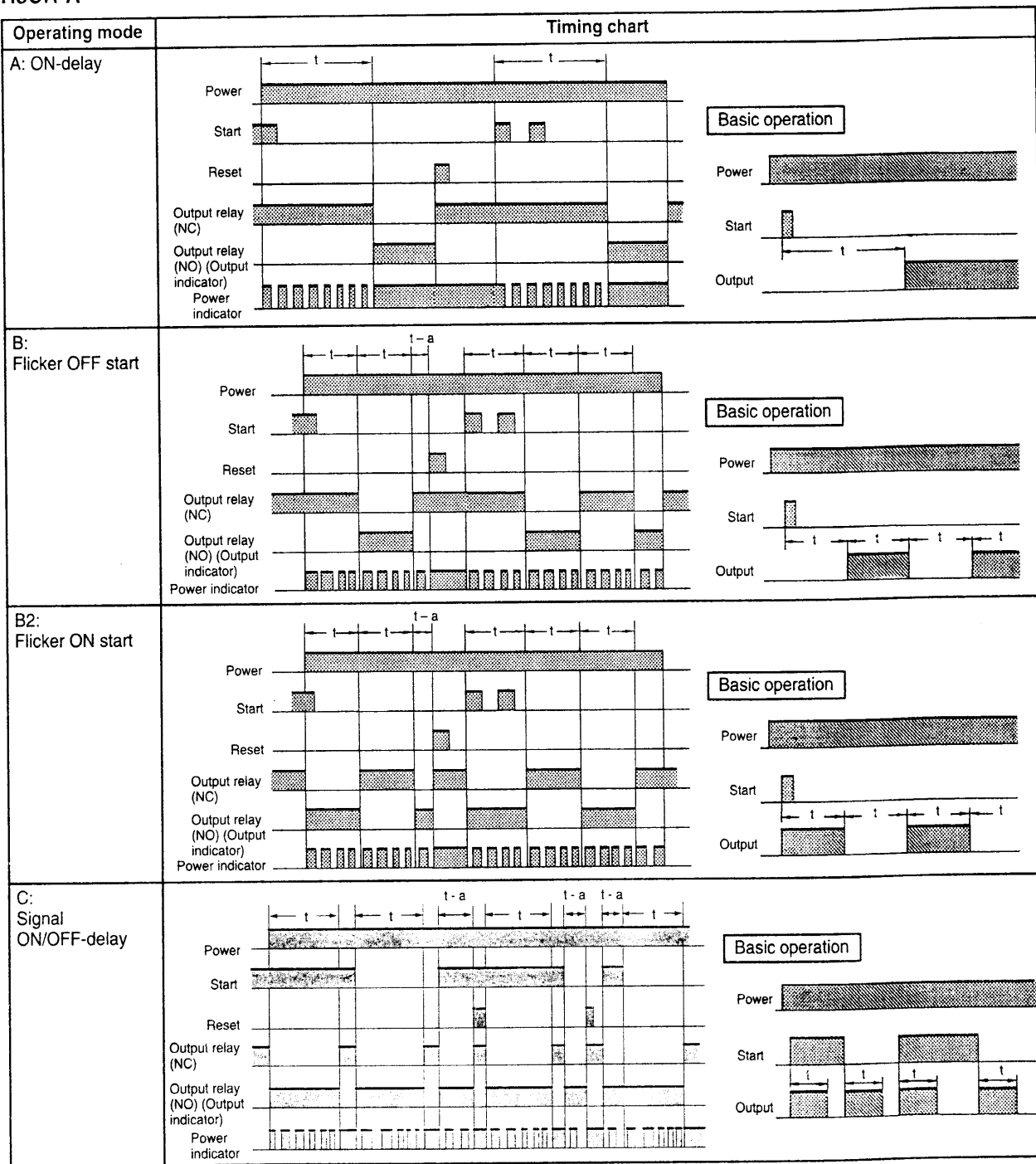

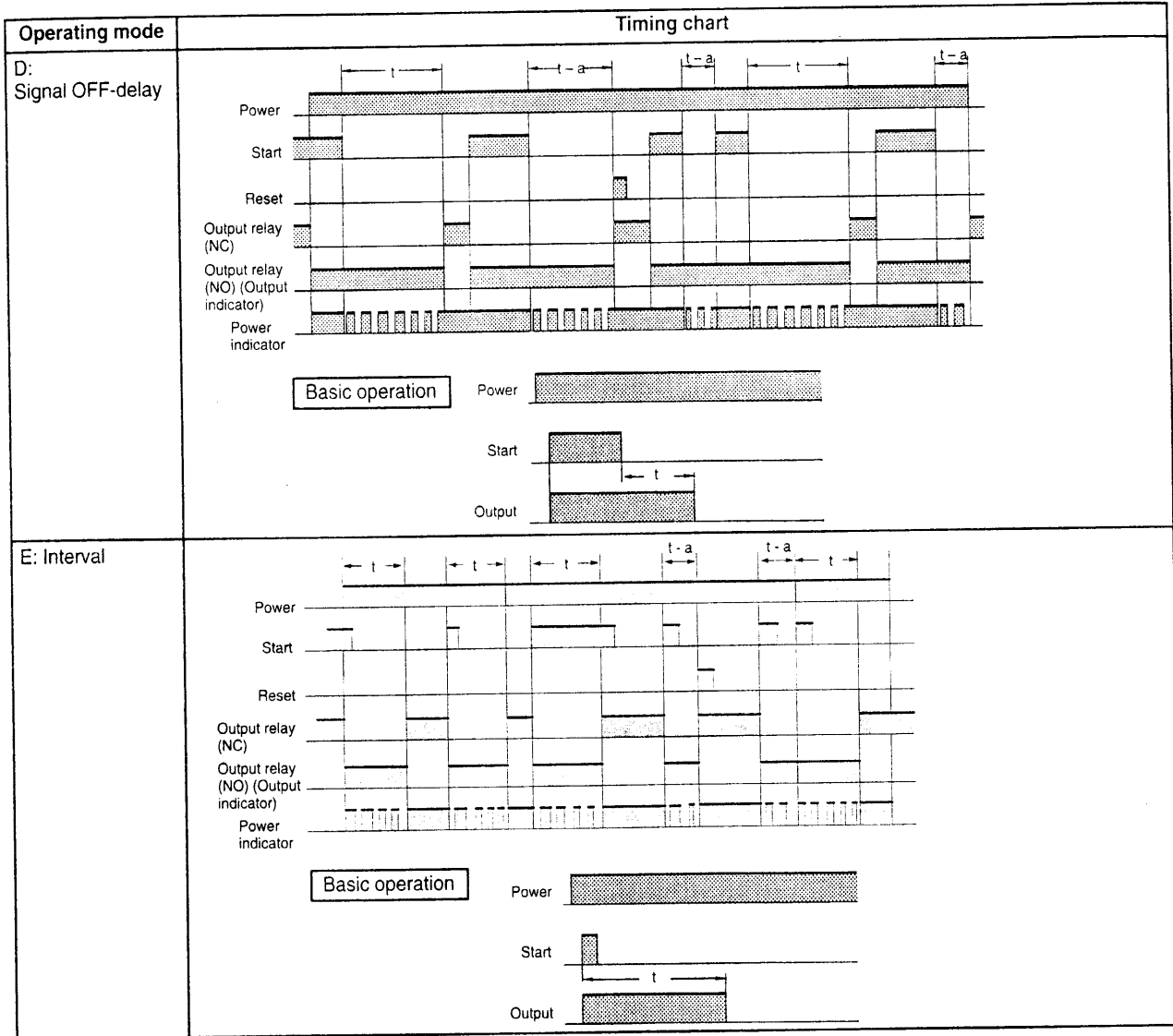

**Gate Signal Input**

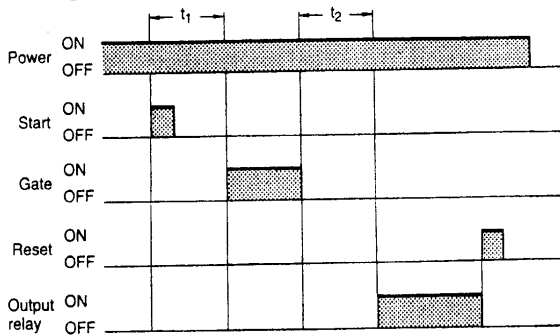

- Note:**
1. This timing chart indicates the gate input in operating mode A (ON-delay operation).
  2. The set time is the sum of  $t_1$  and  $t_2$ .

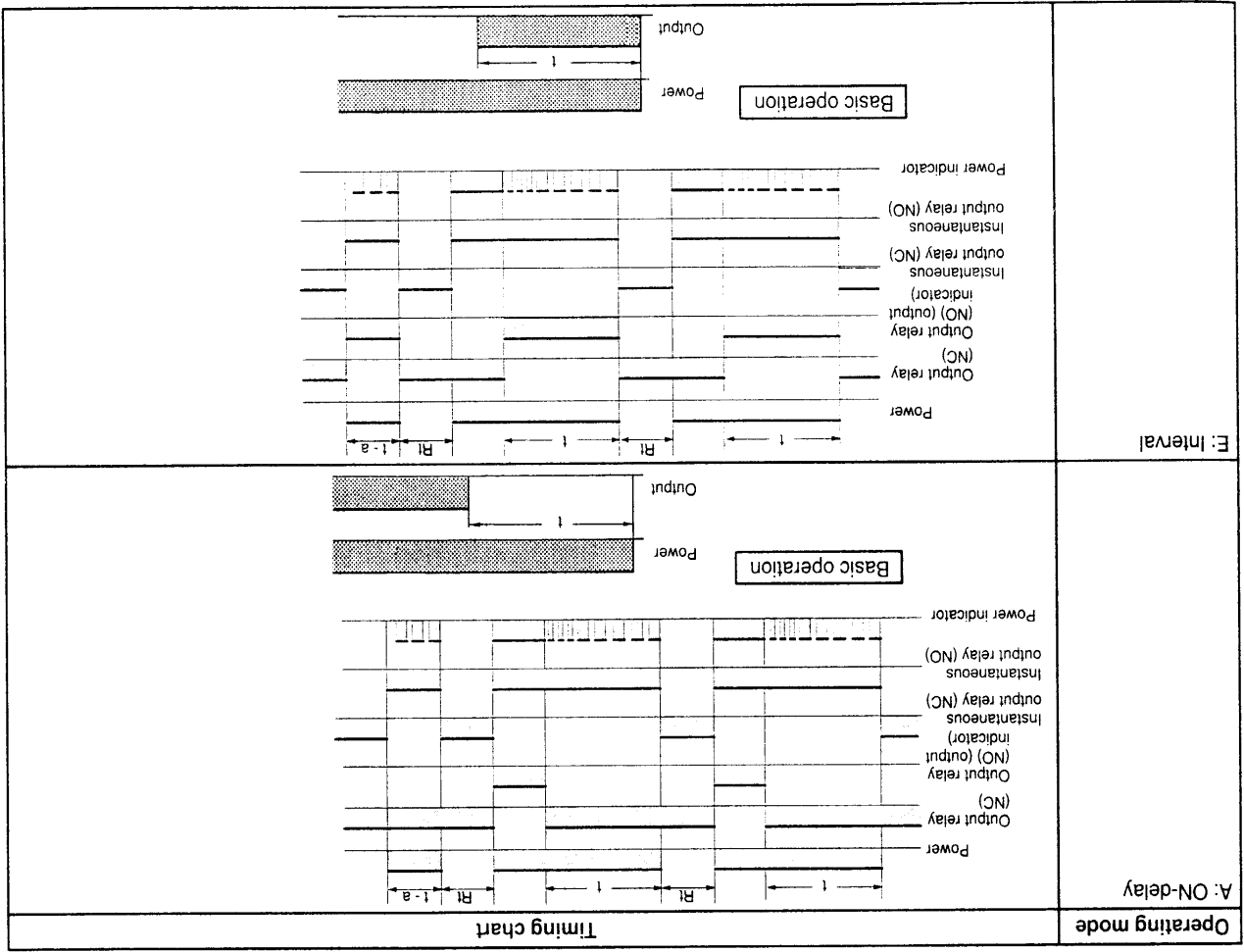

H3CR-A8E/A8E

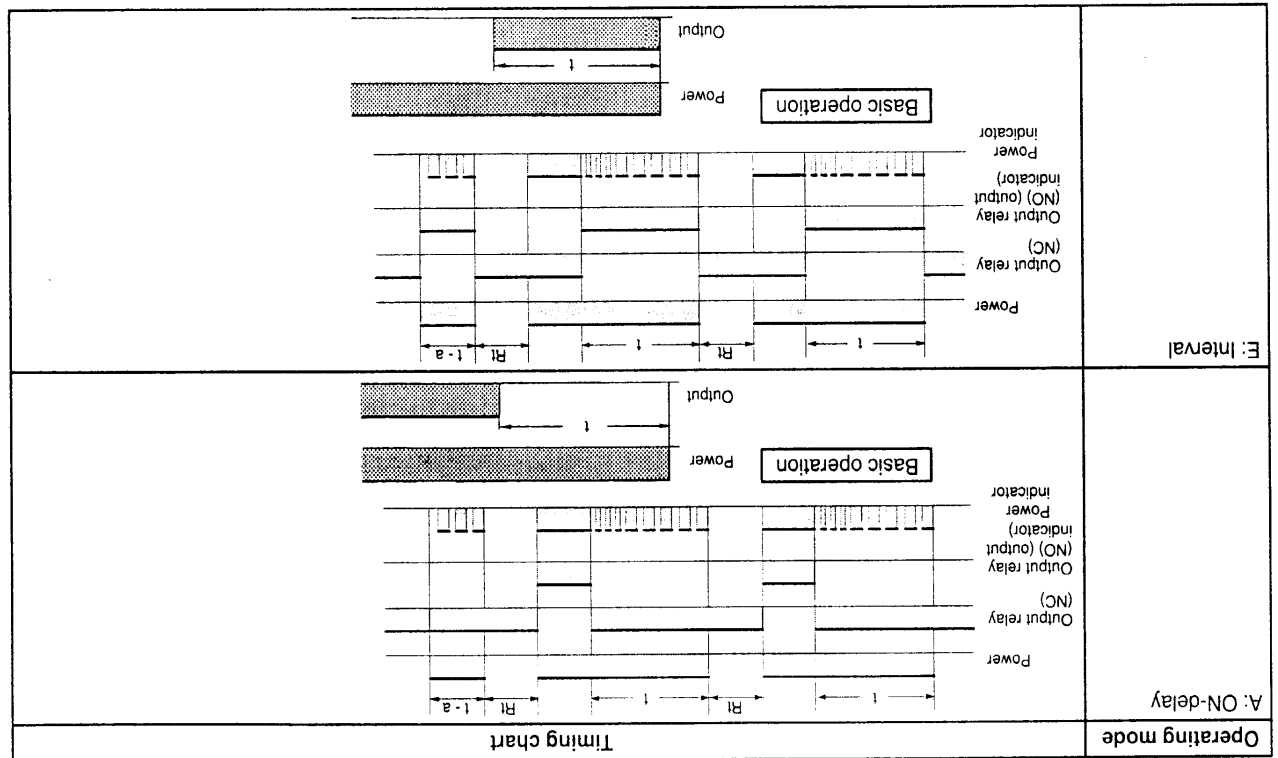

H3CR-A8

## Dimensions

**Note:** All units are in millimetres unless otherwise indicated.  
Panel cutout to be  $45 \times 45 (+0.6_{-0})$

### H3CR-A

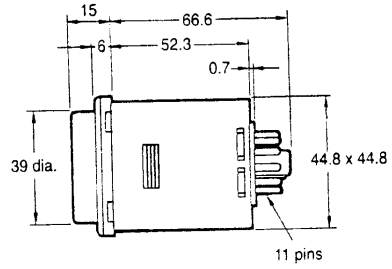
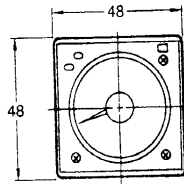
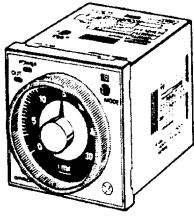

### H3CR-A8 H3CR-A8E

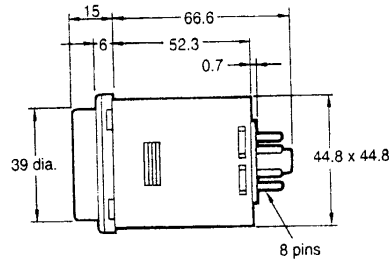
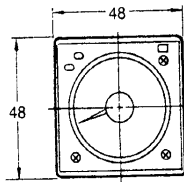
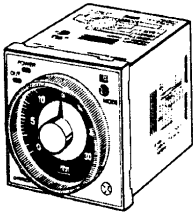

### H3CR-A8EL

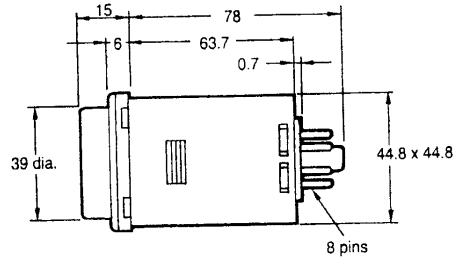
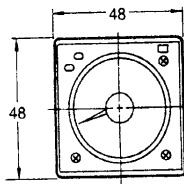
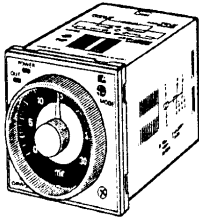

## Installation

### Terminal Arrangement

#### H3CR-A (Contact Output)

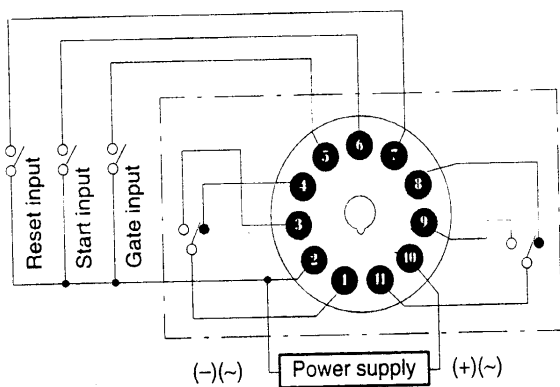

#### H3CR-A8EL/A8E (Contact Output)

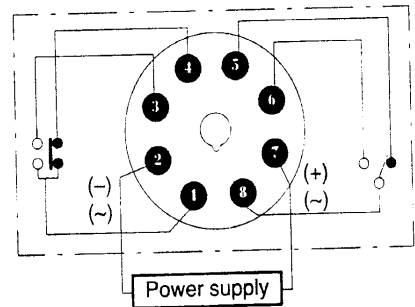

#### H3CR-A8 (Contact Output)

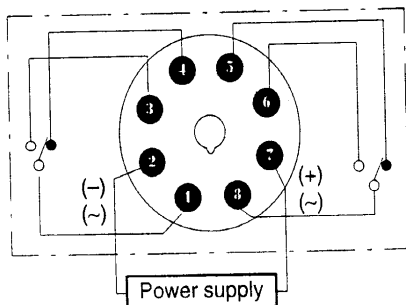



### Input Connections

The inputs of the H3CR are no-voltage (short circuit or open) inputs.

#### No-voltage inputs

**No-contact Input**  
(Connection to NPN open collector output sensor.)

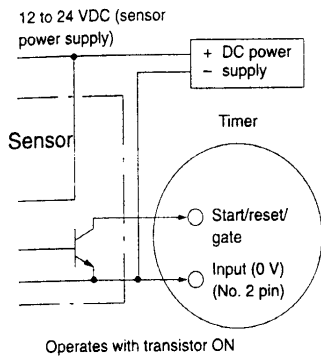

#### Contact Input

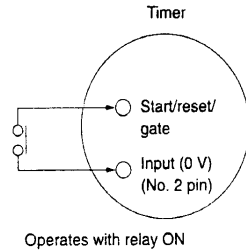

**No-contact Input**  
(Connection to a voltage output sensor.)

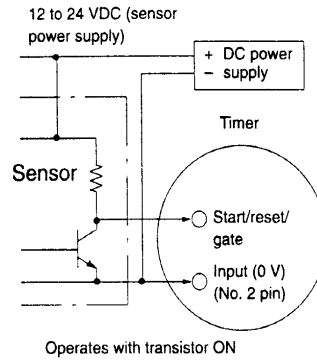

#### No-voltage Input Signal Levels

No-contact input	1. Short-circuit level Transistor ON Residual voltage: 1 V max. Impedance when ON: 1 kΩ max.
	2. Open level Transistor OFF Impedance when OFF: 100 kΩ min.
Contact input	Use contacts which can adequately switch 80 μA at 5 V

## Precautions

### ■ Circuit with Instantaneous Contacts

Refer to the circuit diagrams below. Circuit A is a self-holding circuit with a timer (such as the H3CR-A8EL) that incorporates both instantaneous and time-limit contacts.

The H3CR-A (excluding H3CR-A8EL/-A8E) does not incorporate instantaneous contacts but time-limit contacts only. However, you can still design a self-holding circuit with the H3CR-A. For example, circuit B is a self-holding circuit equivalent to circuit A, which includes the H3CR-A8 in interval mode (i.e. the timer starts the moment power is turned ON and operates for a specified period).

#### Circuit A (with H3CR-A8EL/-A8E)

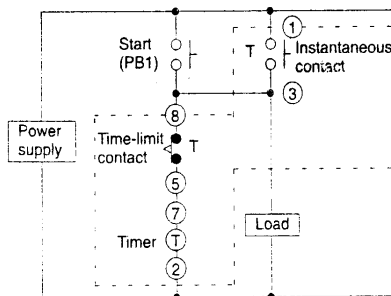

**Note:** No. 1 to 8 are the terminal numbers of the H3CR-A8EL/-A8E.



#### Circuit B (Interval Mode with H3CR-A8)

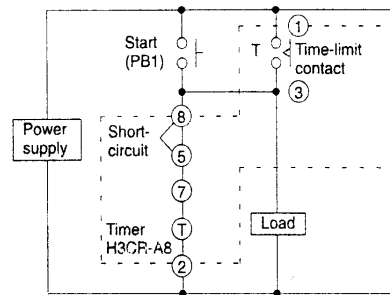

**Note:** No. 1 to 8 are the terminal numbers of the H3CR-A8.

In the case of using H3CR-A8EL/-A8E, refer to note 1 below.  
In the case of using H3CR-A8, refer to note 2 below.

**Note:** 1. In circuit A, the contact between terminals 1 and 3 (instantaneous contact) is ON when PB1 (start switch) is turned on. Terminals 1 and 3 are OFF after a specified period during which the load operates. The moment terminals 5 and 8 are turned OFF, the timer is reset and the load power is switched off.

2. Short-circuit terminals 5 and 8 of the timer socket to change circuit A into circuit B. You need not replace the socket itself. In circuit B, the timer starts the moment power is ON and operates for a specified period.

3. The following is a timing chart for circuits A and B.

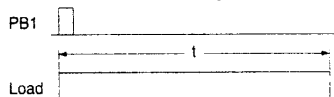

■ Changing of Setting

**NOTICE:** Do not change the time unit, time range, or operation mode while the timer is in operation or malfunction could result.

■ Power Supplies

An AC power supply can be connected to the power input terminals without regarding polarity. A DC power supply must be connected to the power input terminals as designated according to the polarity of the terminals.

A DC power supply can be connected if its ripple factor is 20% or less and the mean voltage is within the rated operating voltage range of the Timer.

Connect the power supply voltage through a relay or switch in such a way that the voltage reaches a fixed value at once or the Timer may not be reset or a timer error could result.

For the power supply of an input device, use an isolating transformer, of which the primary and secondary windings are mutually isolated and the secondary winding is not grounded.

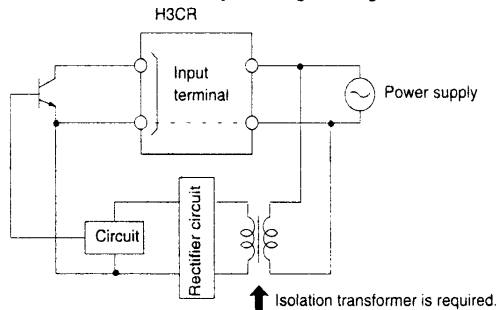

■ Input/Output

An appropriate input is applied to the input signal terminals of the Timer when one of the input terminals (terminals 5, 6, and 7) and the common terminal (terminal 2) for the input signals are short-circuited. Do not attempt to connect any input terminal to any terminal other than the common terminal or to apply voltage across other than the specified input and common terminals or the internal circuits of the Timer may be damaged.

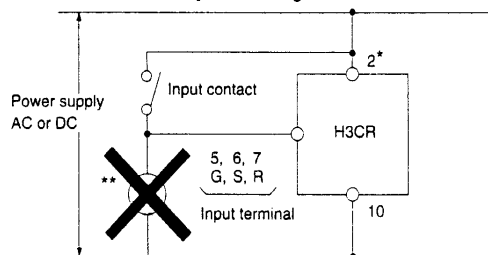

\*Power supply terminal 2 is a common terminal for the input signals (G, S, R) to the Timer. Never use terminal 10 as the common terminal for this purpose, otherwise the internal circuit of the Timer may be damaged.

\*\*Do not connect a relay or any other load between these two points, otherwise the internal circuit of the Timer may be damaged due to the high-tension voltage applied to the input terminals.

When connecting a relay or a transistor as an external signal input device, pay attention to the following points to prevent short-circuiting due to a sneak current to the transformerless power supply. If a relay or transistor is connected to two or more Timers, the input terminals of those Timers must be wired properly so that they will not be different in phase or the terminals will be short-circuited to one another (refer to the figures below).

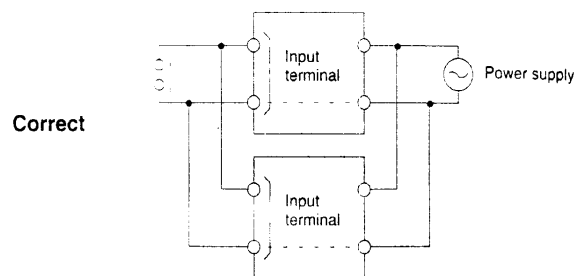
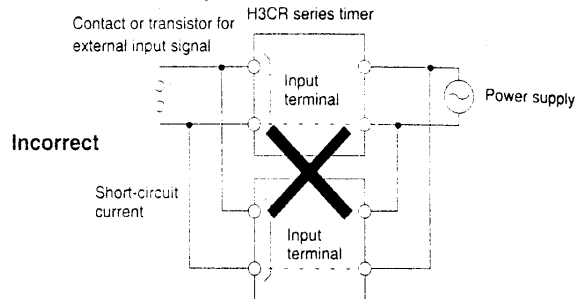

■ Environment

When using the Timer in an area with excess electronic noise, separate the Timer, wiring, and the equipment which generates the input signals as far as possible from the noise sources. It is also recommended to shield the input signal wiring to prevent electronic interference.

Organic solvents (such as paint thinner), as well as very acidic or basic solutions can damage the outer casing of the Timer.

■ Others

If the Timer is mounted on a control board, dismount the timer from the control board or short-circuit the circuitry of the power board before carrying out a voltage withstand test between the electric circuitry and non current-carrying metal part of the Timer, in order to prevent the internal circuitry of the Timer from damage.

Cross References

Cross reference of H3BA-8/H3BA-8H to H3CR-A Timers

H3BA-8	24 VAC	H3CR-A8 24 VAC/VDC
	24 VDC	
	100-120 VAC	H3CR-A8 100-240 VAC
	200-240 VAC	
H3BA-8H	24 VAC	H3CR-A8E 24 VAC/VDC
	24 VDC	
	100-120 VAC	H3CR-A8EL 100-240 VAC
	200-240 VAC	