



**SEMITOP® 3**

## Mosfet Module

**SK 300MB075**

Preliminary Data

### Features

- Compact design
- One screw mounting
- Heat transfer and isolation through direct copper bonded aluminium oxide ceramic (DCB)
- Trench technology
- Short internal connections and low inductance case

### Typical Applications\*

- Low switched mode power supplies
- DC servo drives
- UPS

1) Maximum PCB temperature, at pins/PCB contact, = 85°C

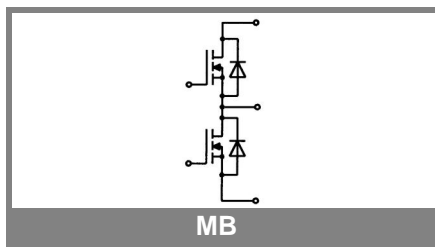

Absolute Maximum Ratings		$T_s = 25\text{ °C}$ , unless otherwise specified	
Symbol	Conditions	Values	Units
<b>MOSFET</b>			
$V_{DSS}$		75	V
$V_{GSS}$		$\pm 20$	V
$I_D$	$T_s = 25\text{ (80) °C}; ^1)$	290 (210)	A
$I_{DM}$	$t_p < 1\text{ ms}; T_s = 25\text{ (80) °C}; ^1)$	580 (420)	A
$T_j$		-40...+150	°C
<b>Inverse diode</b>			
$I_F = -I_D$	$T_s = 25\text{ (80) °C};$	290 (210)	A
$I_{FM} = -I_{DM}$	$t_p < 1\text{ ms}; T_s = 25\text{ (80) °C};$	580 (210)	A
$T_j$		-40...+150	°C
<b>Freewheeling CAL diode</b>			
$I_F = -I_D$	$T_s = \text{°C}$		A
$T_j$			°C
$T_{stg}$		-40 ... +125	°C
$T_{sol}$	Terminals, 10 s	260	°C
$V_{isol}$	a. c. 50 Hz; r.m.s.; 1 min (1s)	2500 / 3000	V

Characteristics		$T_s = 25\text{ °C}$ , unless otherwise specified			
Symbol	Conditions	min.	typ.	max.	Units
<b>MOSFET</b>					
$V_{(BR)DSS}$	$V_{GS} = 0\text{ V}; I_D = 5,6\text{ mA}$	$\geq V_{DSS}$			V
$V_{GS(th)}$	$V_{GS} = V_{DS}; I_D = 5,6\text{ mA}$	2,5	3,3		V
$I_{DSS}$	$V_{GS} = 0\text{ V}; V_{DS} = V_{DSS}; T_j = 25\text{ (125) °C}$			100 (500)	$\mu\text{A}$
$I_{GSS}$	$V_{GS} = 20\text{ V}; V_{DS} = 0\text{ V}$			100	nA
$R_{DS(on)}$	$I_D = 200\text{ A}; V_{GS} = 10\text{ V}; T_j = 25\text{ °C}$			1,6	m $\Omega$
$R_{DS(on)}$	$I_D = 200\text{ A}; V_{GS} = 10\text{ V}; T_j = 125\text{ °C}$		2,3	3	m $\Omega$
$C_{CHC}$	per MOSFET				pF
$C_{iss}$	under following conditions:		18,9		nF
$C_{oss}$	$V_{GS} = 0\text{ V}; V_{DS} = 25\text{ V}; f = 1\text{ MHz}$		3,6		nF
$C_{rss}$			1,1		nF
$L_{DS}$			2,2		nH
$t_{d(on)}$	under following conditions:		350		ns
$t_r$	$V_{DD} = 40\text{ V}; V_{GS} = 10\text{ V};$ $I_D = 300\text{ A}$		620		ns
$t_{d(off)}$	$R_G = 25\text{ }\Omega$		1250		ns
$t_f$			400		ns
$R_{th(j-s)}$	per MOSFET (per module)			0,45	K/W
<b>Inverse diode</b>					
$V_{SD}$	$I_F = 300\text{ A}; V_{GS} = 0\text{ V}; T_j = 25\text{ °C}$		0,8		V
$I_{RRM}$	under following conditions:				A
$Q_{rr}$	$I_F = \text{A}; T_{vj} = \text{°C}; R_G = \Omega$				$\mu\text{C}$
$t_{rr}$	$V_R = \text{A}; di/dt = \text{A}/\mu\text{s}$				ns
<b>Free-wheeling diode</b>					
$V_F$	$I_F = \text{A}; V_{GS} = \text{V}$				V
$I_{RRM}$	under following conditions:				A
$Q_{rr}$	$I_F = \text{A}; T_{vj} = \text{°C}$				$\mu\text{C}$
$t_{rr}$	$V_r = \text{A}; di/dt = \text{A}/\mu\text{s}$				ns
<b>Mechanical data</b>					
M1	mounting torque			2,5	Nm
w			30		g
Case	SEMITOP® 3		T 24		

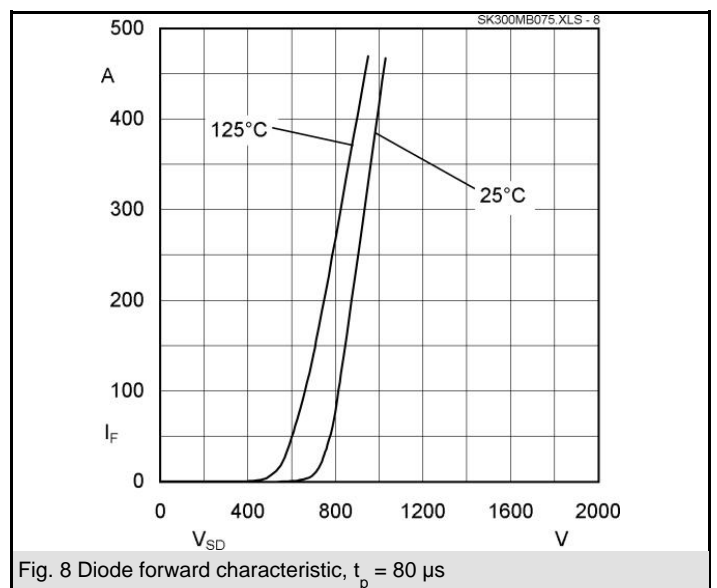
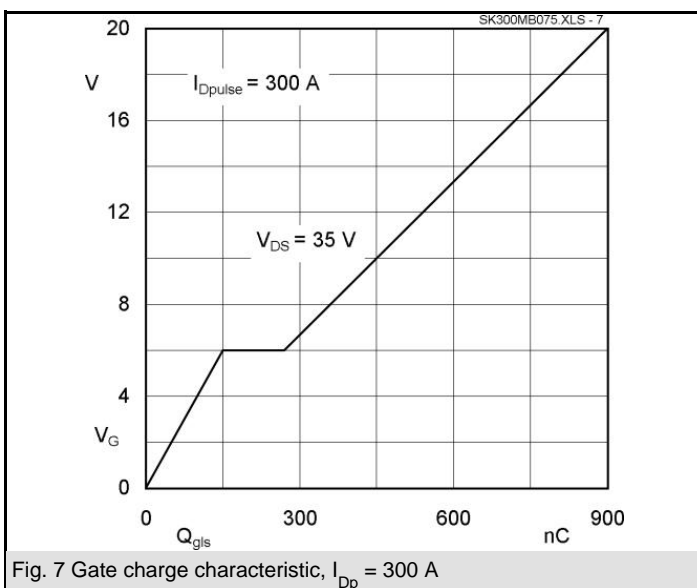
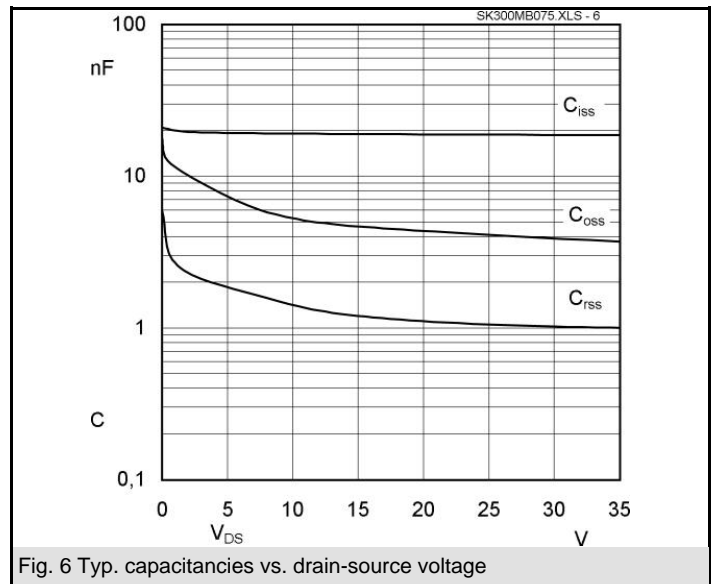
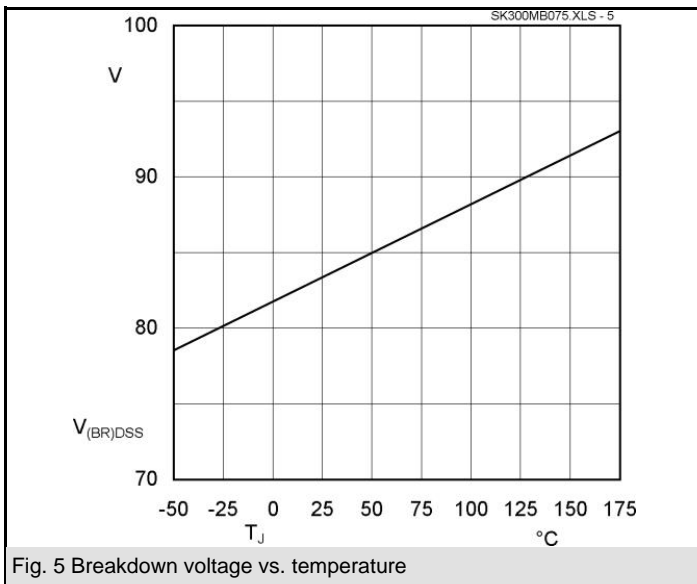
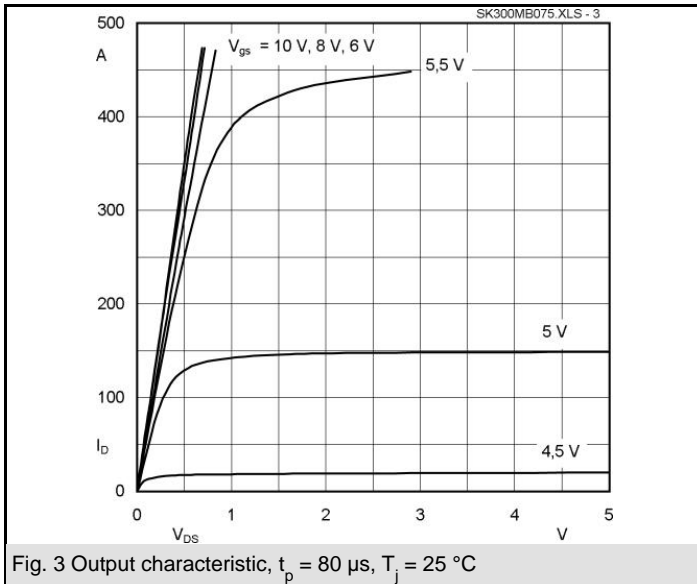

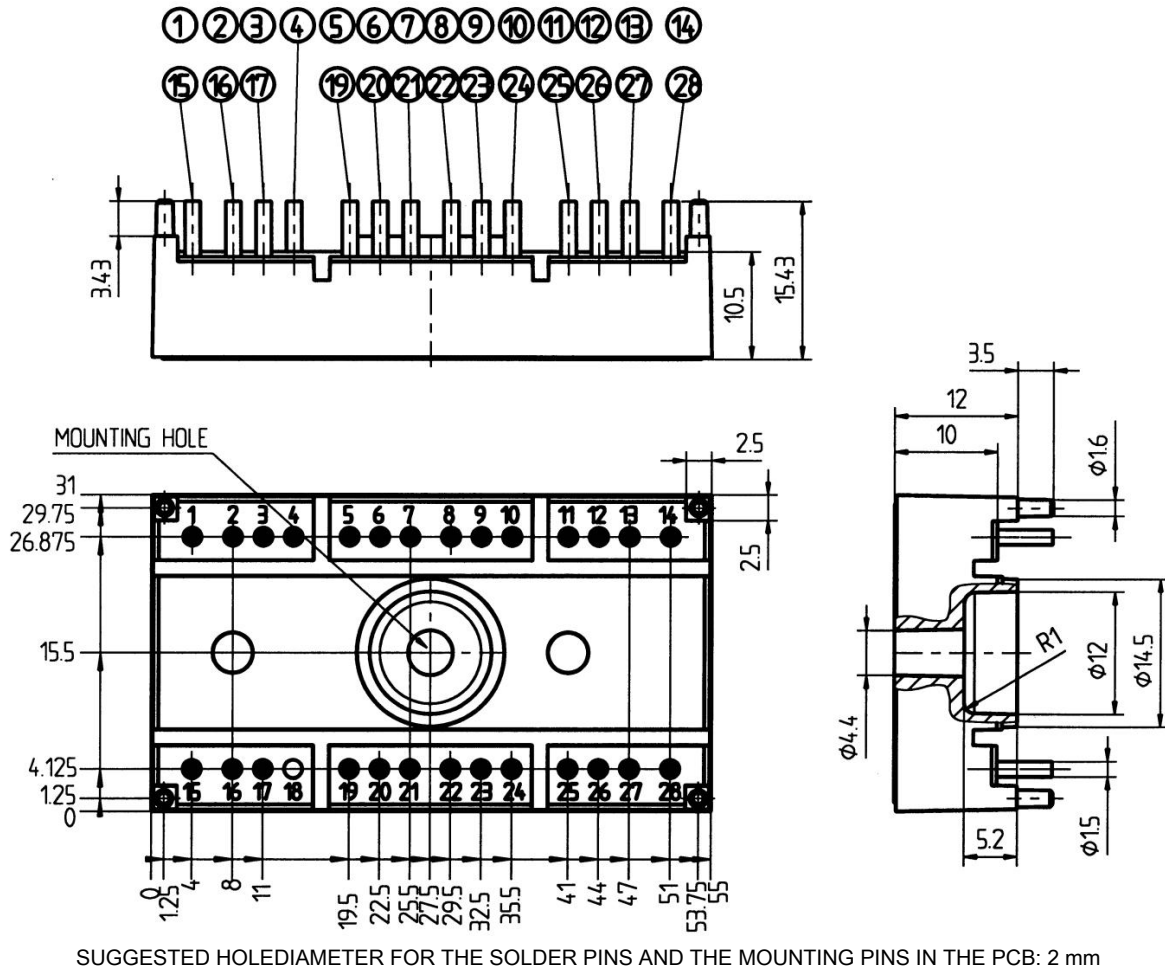

Case T24

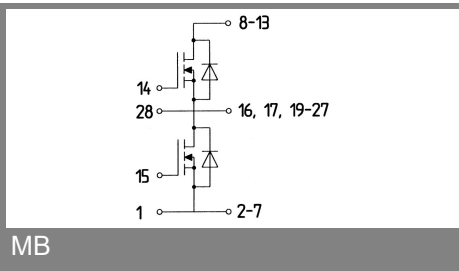

This is an electrostatic discharge sensitive device (ESDS), international standard IEC 60747-1, Chapter IX.

\* The specifications of our components may not be considered as an assurance of component characteristics. Components have to be tested for the respective application. Adjustments may be necessary. The use of SEMIKRON products in life support appliances and systems is subject to prior specification and written approval by SEMIKRON. We therefore strongly recommend prior consultation of our personal.