

# Agilent HLMP-Nxxx T-1 (3 mm) Auto Insertable LED Lamps Data Sheet

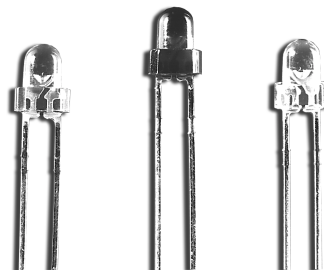

**HLMP-N305, HLMP-N405, HLMP-NG0x,  
HLMP-NL06, HLMP-NH04**

## Description

This family of 3 mm LED Lamps is capable of withstanding automatic insertion and wave soldering processes.

Designed with a thick epoxy flange and soft leadframe material, it is ideal for clinch and cut operations.

## Features

- T-1 (3 mm) auto insertable package
- AllnGaP *SunPower* intensity
- High light output
- Tinted diffused and tinted non-diffused lens options
- Wide viewing angle
- Variety of colors
- Available with straight or formed lead tape and reel options

## Applications

- General purpose
- High volume manufacturing

## Device Selection Guides

High Brightness Lamps		Package		Luminous Intensity, Min. Iv @ 20 mA	Viewing Angle, 2θ <sup>1/2</sup>	Package Outline
Color	Part Number	Tinted	Diffused			
Red	HLMP-NG05	μ		90.2	45	A
	HLMP-NG07	μ		90.2	60	B
Amber	HLMP-NL06	μ		96.2	60	B
Red Orange	HLMP-NH04			90.2	60	B

High Efficiency Lamps		Package		Luminous Intensity, Min. Iv @ 10 mA	Viewing Angle, 2θ <sup>1/2</sup>	Package Outline
Color	Part Number	Tinted	Diffused			
GaP Yellow	HLMP-N305	X		14.7	45	A
GaP Orange	HLMP-N405	X		13.8	45	A

### Note:

1. 2θ<sup>1/2</sup> is the off axis angle where the luminous intensity is 1/2 the on axis intensity.



Package Dimensions  
Package Outline "A"

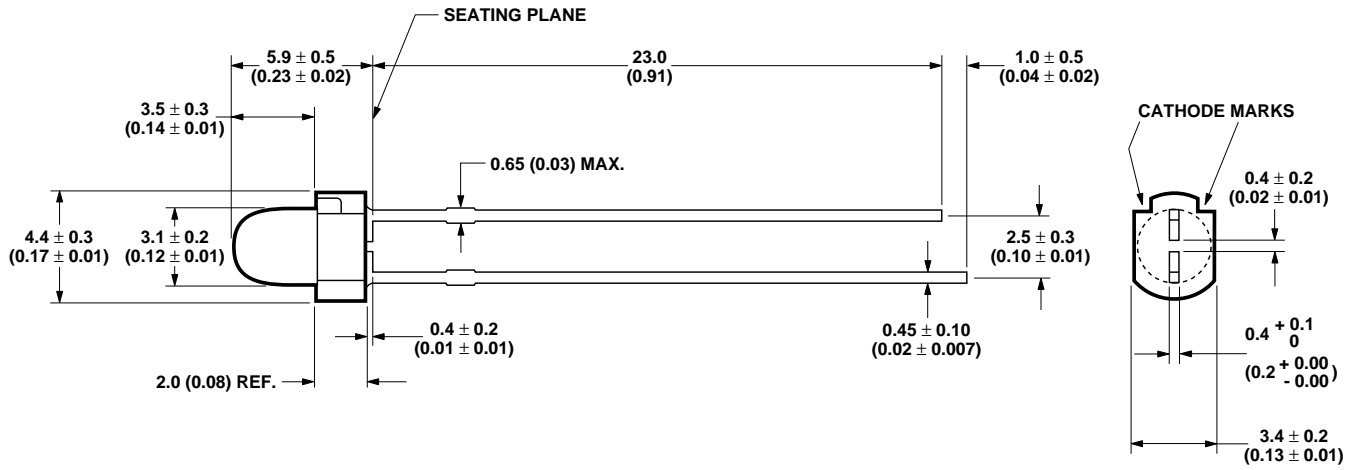

Package Outline "B"

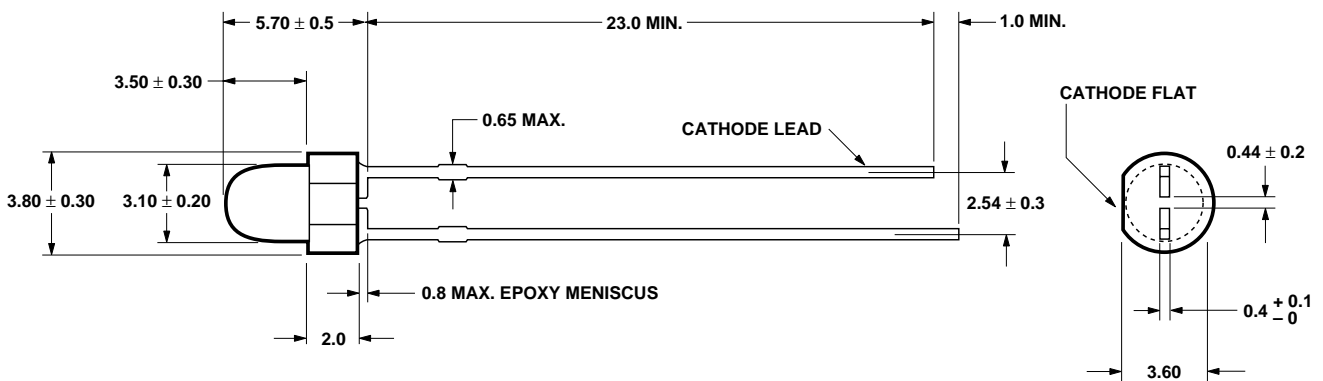

NOTES:

1. ALL DIMENSIONS ARE IN MILLIMETERS (INCHES).
2. LEADS ARE MILD STEEL. SOLDER COATED.
3. EPOXY MENISCUS OF 0.8 mm (0.03 in.) MAXIMUM MAY EXTEND TO THE LEADS.

## Part Numbering System

HLMP - N x xx # xxx

### Mechanical Option

002: Tape & Reel, Straight Leads

### Viewing Angle Options

01: 45 Degree

05: 45 Degree

04, 06, 07: 60 Degree

### Color Options

3: GaP Yellow

4: GaP Orange

G: AlInGaP Red

L: AlInGaP Amber

H: AlInGaP Red Orange

## Absolute Maximum Ratings at $T_A = 25\text{ }^\circ\text{C}$

Parameter	Orange	Yellow	All <sup>n</sup> GaP Red Orange, Amber & Red	Units
DC Forward Current <sup>[1]</sup>	30	20	30 <sup>[2,3]</sup>	mA
Reverse Voltage ( $I_r = 100\text{ }\mu\text{A}$ )		5		V
Junction Temperature, $T_{jmax}$		110		$^\circ\text{C}$
Storage Temperature Range		-40 to +85		$^\circ\text{C}$
Operating Temperature Range		-20 to +85	-40 to +85	$^\circ\text{C}$
Wave Soldering Temperature [1.59 mm (0.063 in.) from body]		250 $^\circ\text{C}$ for 3 seconds		
Solder Dipping Temperature [1.59 mm (0.063 in.) from body]		260 $^\circ\text{C}$ for 5 seconds		

### Notes:

1. See Figure 4 for maximum current derating vs. ambient temperature.
2. Suggested minimum DC current: 10 mA.
3. Maximum Peak Pulsed Forward Current: 50 mA, 30 mA average.

### Electrical Characteristics at $T_A = 25^\circ\text{C}$

Part Number	Forward Voltage $V_f$ (Volts)			Capacitance $C$ (pF) $V_f = 0,$ $f = 1$ MHz Typ.	Thermal Resistance $R\theta_{J-PIN}$ ( $^\circ\text{C}/\text{W}$ )	Speed of Response $\tau_s$ (ns) Time Constant $e^{-t}/\tau_s$ Typ.
	Typ.	Max.	$I_f$ (mA)			
HLMP-N30x	2.00	2.6	10	15	290	90
HLMP-N40x	1.90	2.6	10	4	290	280
HLMP-NL06 <sup>[1]</sup>	2.02	2.4	20	40	240	20
HLMP-NG0x <sup>[1]</sup>	1.90	2.4	20	40	240	20
HLMP-NH04	1.94	2.4	20	40	250	20

**Note:**

1. Please contact your Agilent Sales Representative about operating currents below 10 mA.

### Optical Characteristics at $T_A = 25^\circ\text{C}$

Part Number	Luminous Intensity		Typ. Peak Wavelength (nm)	Typ. Dominant Wavelength (nm)	Typ. Spectral Half Width	Luminous Efficacy Width (lm/W)
	Min.	$I_f$ (mA)				
HLMP-NG05	90.2	20	635	626	17	150
HLMP-NG07	90.2	20	635	626	17	150
HLMP-NL06	96.2	20	592	590	17	480
HLMP-N305	14.7	10	583	585	36	500
HLMP-N405	13.8	10	600	602	37	380
HLMP-NH04	90.2	20	621	615	17	235

**Notes:**

1. The luminous intensity,  $I_v$ , is measured at the mechanical axis of the lamp package. The actual peak of the spatial radiation pattern may not be aligned with this axis.
2. The dominant wavelength,  $\lambda_d$ , is derived from the CIE Chromaticity Diagram and represents the color of the device.
3. The radiant intensity,  $I_e$ , in watts per steradian, may be found from the equation  $I_e = I_v/\eta_v$ , where  $I_v$  is the luminous intensity in candelas and  $\eta_v$  is the luminous efficacy in lumens/watt.

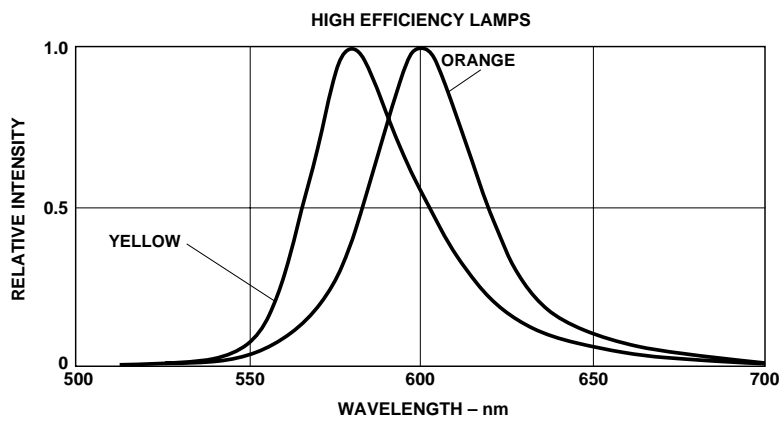
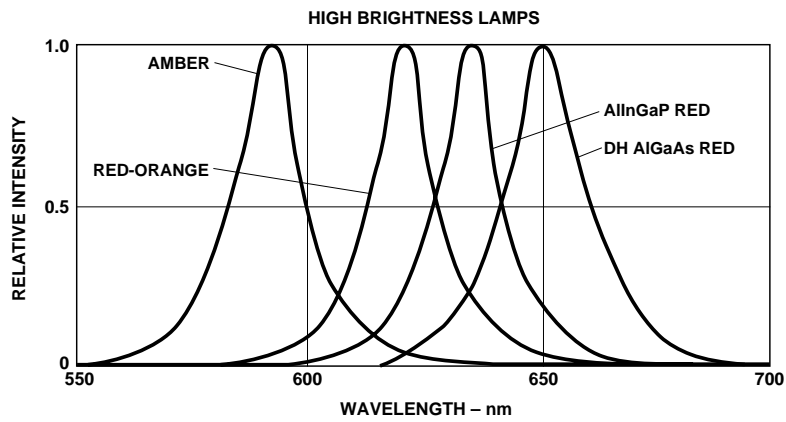

Figure 1. Relative intensity vs. peak wavelength.

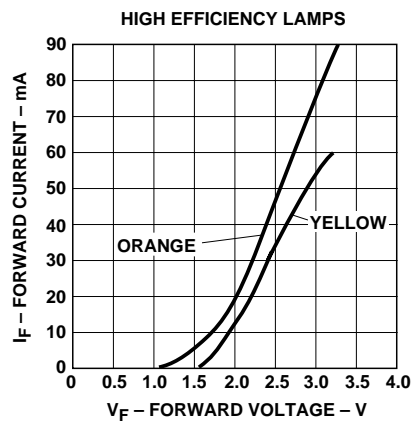
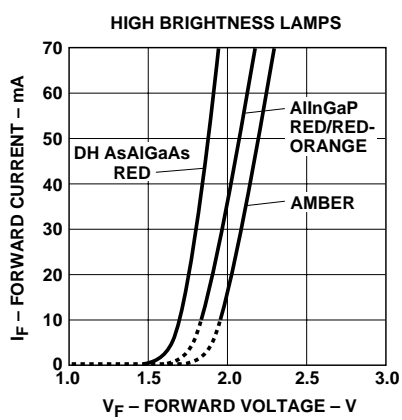

Figure 2. Forward current vs. forward voltage.

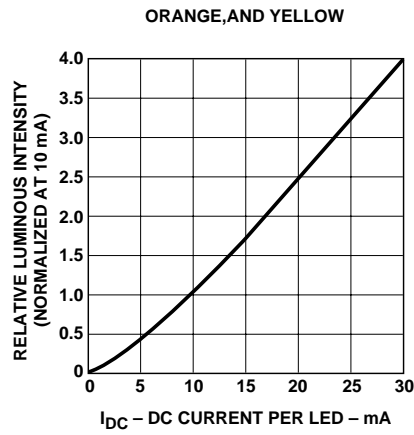
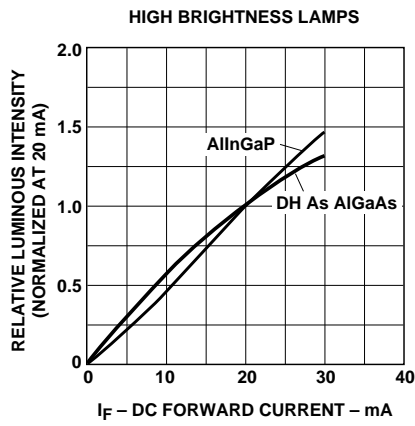

Figure 3. Relative luminous intensity vs. forward current.

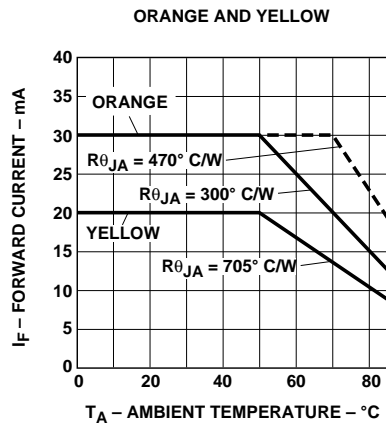
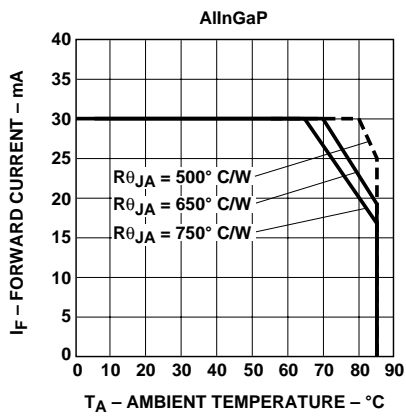

Figure 4. Maximum forward DC current vs. ambient temperature.

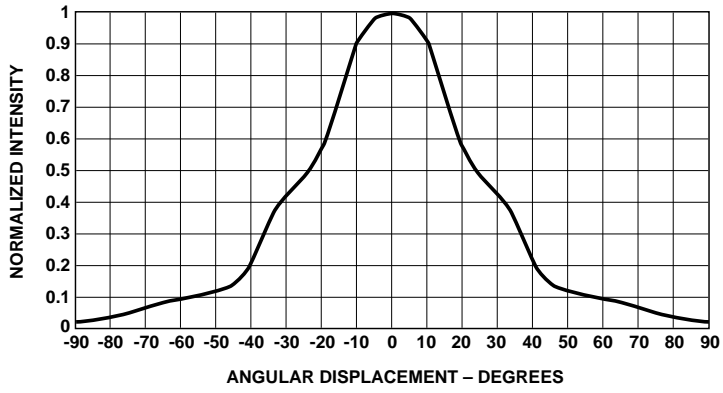

Figure 5. Representative spatial radiation pattern for 45° viewing angle.

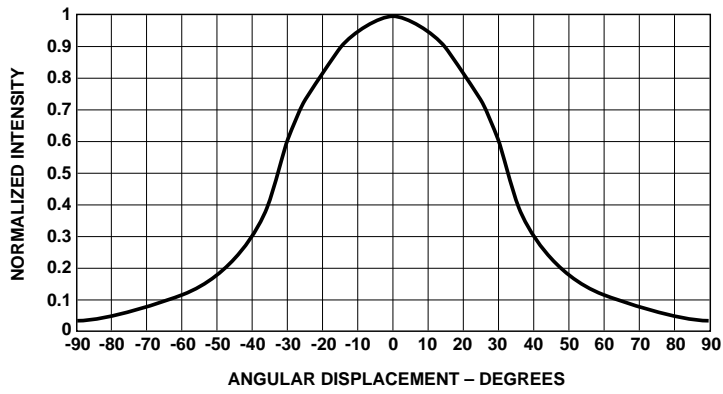

Figure 6. Representative spatial radiation pattern for 60° viewing angle.

**Intensity Bin Limits**

Color	Bin	Intensity Range (mcd)	
		Min.	Max.
Red/Orange /Red-Orange	H	13.8	27.6
	I	22.0	44.0
	J	35.2	70.4
	K	56.4	112.8
	L	90.2	180.4
	M	138.0	276.0
	N	200.0	400.0
	O	290.0	580.0
	P	500.0	1000.0
	Q	700.0	1400.0
	R	1000.0	2000.0
	S	1400.0	2800.0
	T	2000.0	4000.0
	U	2900.0	5800.0
	V	4200.0	8400.0
	W	6000.0	12000.0
	X	8700.0	17400.0
	Y	12600.0	25200.0
	Z	18200.0	36400.0
Yellow	G	14.7	29.4
	H	23.5	47.0
	I	37.6	75.2
	J	60.1	120.2
	K	96.2	192.4
	L	147.0	294.0
	M	212.0	424.0
	N	300.0	600.0
	O	450.0	900.0
	P	700.0	1400.0
	Q	1000.0	2000.0
	R	1600.0	3200.0
	S	2600.0	5200.0
T	4000.0	8000.0	
U	6500.0	13000.0	
V	10000.0	20000.0	
W	16000.0	30000.0	

Maximum tolerance for each bin limit is  $\pm 18\%$ .



### Color Categories

Color	Category #	Lambda (nm)	
		Min.	Max.
Yellow	1	582.0	584.5
	3	584.5	587.0
	2	587.0	589.5
	4	589.5	592.0
	5	592.0	593.0
Orange	1	597.0	599.5
	2	599.5	602.0
	3	602.0	604.5
	4	604.5	607.5
	5	607.5	610.5
	6	610.5	613.5
	7	613.5	616.5
	8	616.5	619.5

Tolerance for each bin limit is  $\pm 0.5$  nm.

### Taping Options

Option	Straight Lead		
	#002	#2CA	#2CD
Dimension "B"	–	–	–
Dimension "H"	20.5 $\pm$ 1.0 (0.81 $\pm$ 0.04)	18.0 $\pm$ 1.0 (0.71 $\pm$ 0.04)	20.5 $\pm$ 1.0 (0.81 $\pm$ 0.04)

Option	Formed Lead						
	#2UK	#2UL	#2UM	#2UN	#2UP	#2UQ	#2UR
Dimension "B"	12.0 $\pm$ 1.0 (0.47 $\pm$ 0.04)	9.0 $\pm$ 1.0 (0.35 $\pm$ 0.04)	10.0 $\pm$ 1.0 (0.39 $\pm$ 0.04)	11.0 $\pm$ 1.0 (0.43 $\pm$ 0.04)	13.0 $\pm$ 1.0 (0.51 $\pm$ 0.04)	14.0 $\pm$ 1.0 (0.55 $\pm$ 0.04)	15.0 $\pm$ 1.0 (0.59 $\pm$ 0.04)
Dimension "H"	16.0 $\pm$ 1.0 (0.63 $\pm$ 0.04)						

Units: mm (inches)



**Package Options**

Lead Option	Ammo Pack (1000 pcs.)	Tape & Reel (2000 pcs.)
Straight Lead	#2C —	#002
Formed Lead	#2U —	—

**Recommended Assembly Condition**

- A single-sided phenolic printed circuit board (PCB) is preferred. Double-sided PCB and other materials may cause greater lead stress.

Recommended through-hole diameter is 0.93 to 1.03 mm. Leadlength below the PCB should be 1.5 to 2.0 mm, and the clinching angle (angle between the lead and PCB) should be 30 ±10 degrees.

- If SMT devices and an adhesive are used on the same pcb as these lamps, the adhesive should be cured before the lamps are auto-inserted. If curing must be done after lamp insertion, the cure temperature and time should not exceed 140°C, 100 seconds. This is the temperature of the surface normal to the IR source.

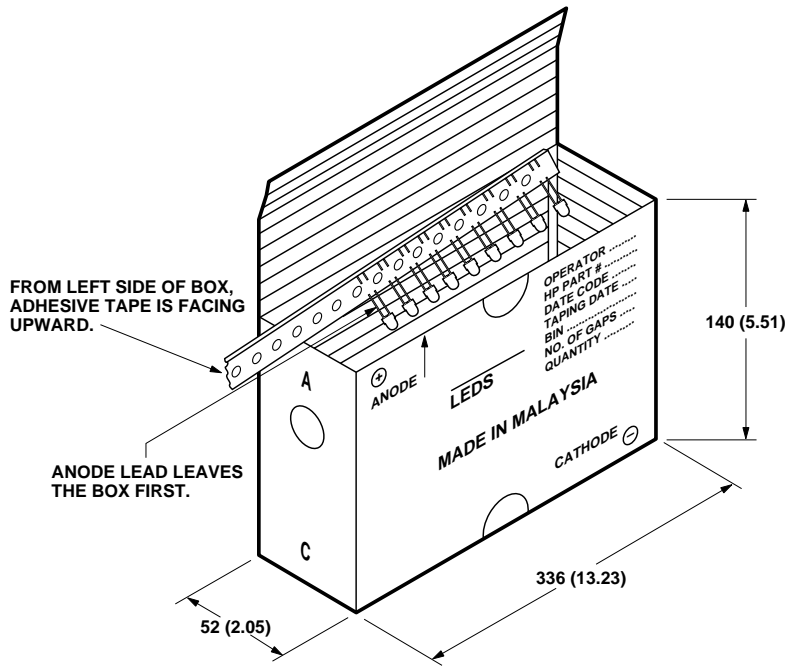

DIMENSIONS IN MILLIMETERS (INCHES).

**AMMO PACK (for All options except #002)**

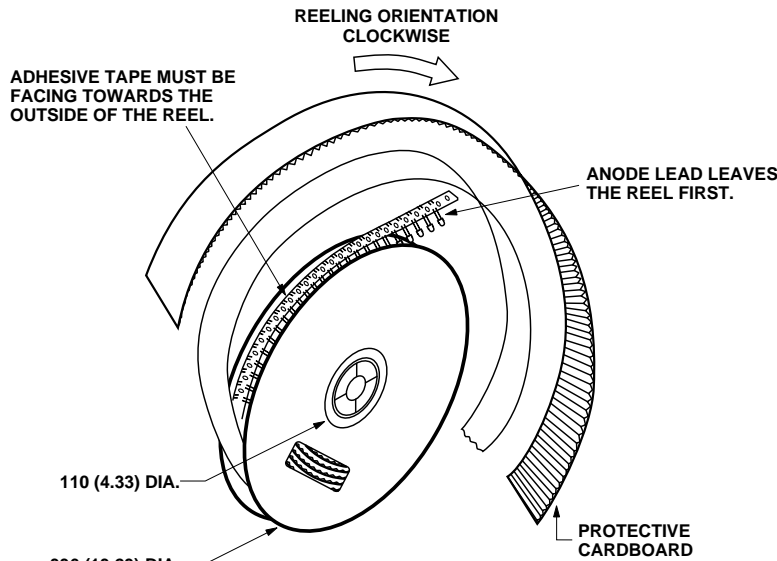

DIMENSIONS IN MILLIMETERS (INCHES).

**TAPE & REEL (for option #002 only)**

**[www.agilent.com/semiconductors](http://www.agilent.com/semiconductors)**

For product information and a complete list of distributors, please go to our web site.

For technical assistance call:

Americas/Canada: +1 (800) 235-0312 or (916) 788-6763

Europe: +49 (0) 6441 92460

China: 10800 650 0017

Hong Kong: (+65) 6756 2394

India, Australia, New Zealand: (+65) 6755 1939

Japan: (+81 3) 3335-8152 (Domestic/International), or 0120-61-1280 (Domestic Only)

Korea: (+65) 6755 1989

Singapore, Malaysia, Vietnam, Thailand, Philippines, Indonesia: (+65) 6755 2044

Taiwan: (+65) 6755 1843

Data subject to change.

Copyright © 2005 Agilent Technologies, Inc.

Obsoletes 5988-9725EN

May 1, 2005

5989-2813EN



**Agilent Technologies**