

Safety switches with separate actuator and interlock

SLK

Safelock *Family*
 Plastic body
 Protection class IP 67
 Safety door locking via spring or solenoid

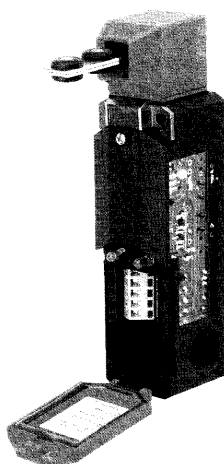

Product advantages

- **Safety** built into the system through two independent safety circuits, flexible contact assembly with max. 4 NC →
- **Universal** integration into system due to multiple voltage supply 24–48 V DC and 24–230 V AC (Standard: 24 V AC/DC)
- **Flexible** in practice thanks to rotatable actuating head (4 x 90°) and horizontal or vertical operation
- **Compact** design with slim dimensions and only 170 mm long
- **Innovative** in installation thanks to cage-clamp connection technology.
- **Function** according to GS ET 19, EN 60 204-1 and EN 60 947-5-1.

Safety in practice



The actuator made from stainless steel guarantees reliable operation. The coding prevents manipulation and bypassing in the "simplest possible way". The optional radius actuator allows smaller safety doors to be monitored. It can be installed horizontally or vertically, and is also made from stainless steel.

Innovative in installation

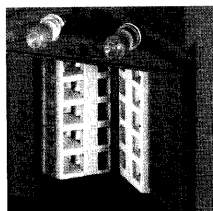

The electrical connection of the SLK is safe and reliable. A terminal block with cage-clamp terminal connectors is used. The terminal compartment is separate from all working parts ensuring that the connections are safely made. A terminal block with conventional screw-type connections is also optionally available.

The terminal compartment is designed according to protection class IP 67.

The LED indicator showing the actual status is optional.

Flexible in practice

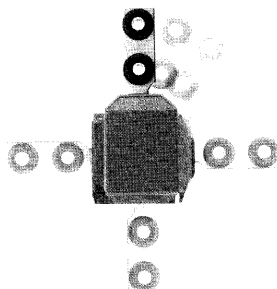

The SLK can be operated both horizontally and vertically. The necessary pre-setting is carried out before mounting by simply adjusting the actuating head. This flexible method of mounting is supported by the ability to position the actuating head in 4 x 90° increments.

Safety in demanding environmental conditions

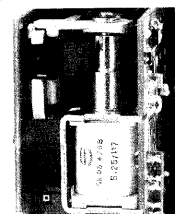

The use of an innovative electromechanical system (Bernstein patent) consisting of a solenoid actuator, electro-magnetic keeper and electronic controller, results in a very low power consumption. This allows reliable continuous operation even in high ambient temperatures.

Universal integration in system

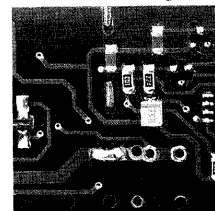

In the multiple voltage version, the SLK can be connected to all control voltages from 24 to 48 V DC as well as from 24 to 230 V AC. The standard SLK is equipped for a control voltage of 24 V DC/AC.

High-level safety at low cost

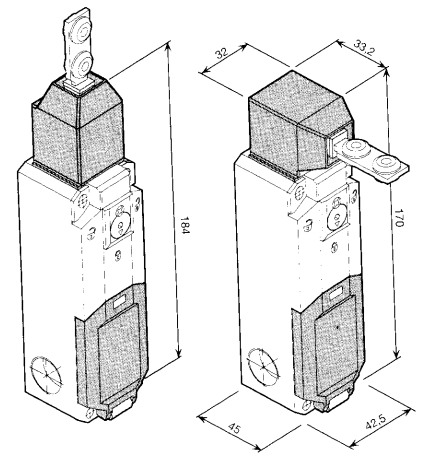
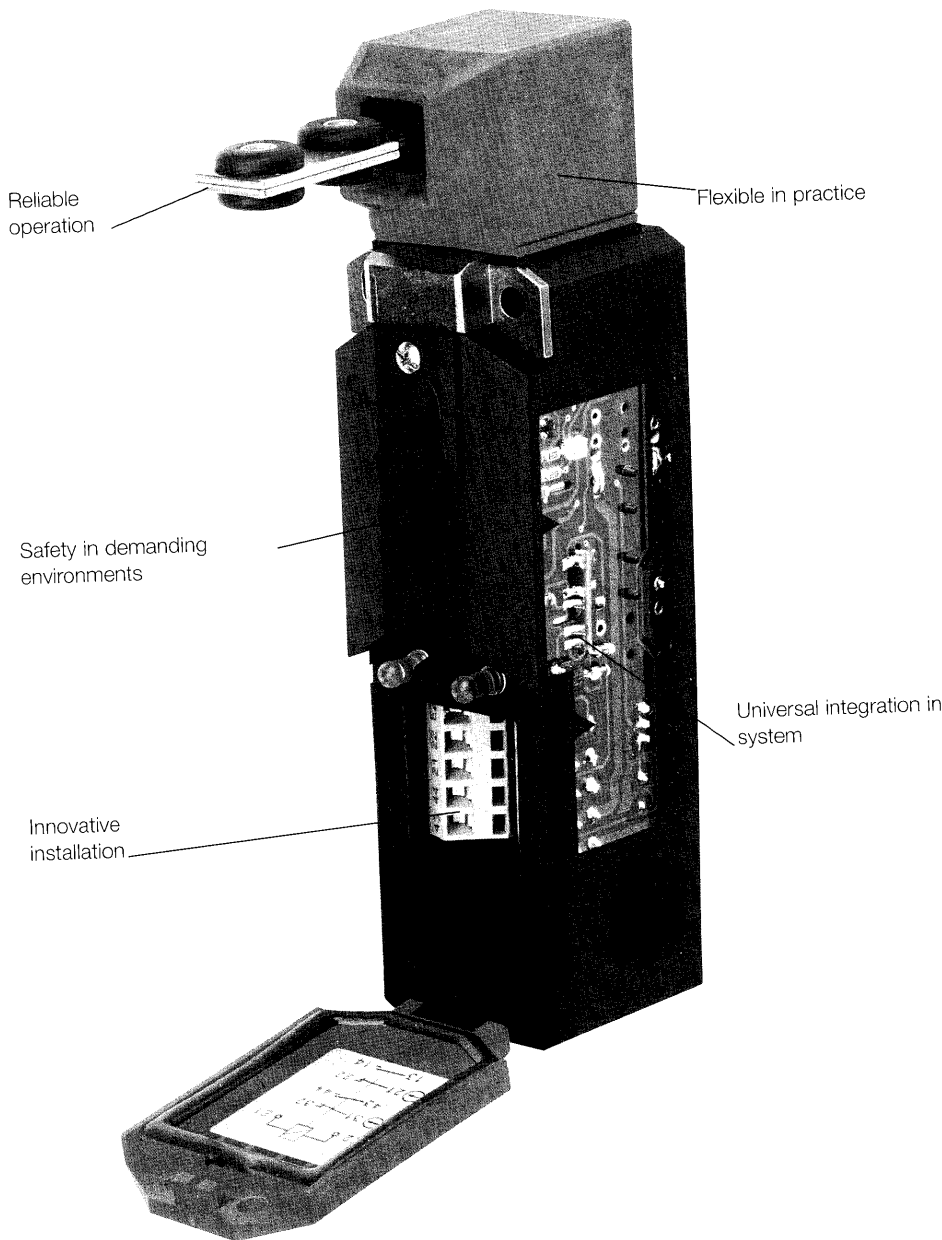

Mounting

- The safety switch is mounted using a minimum of two M5 screws in the mounting holes.
- The separate actuator is to be suitably secured to prevent unintentional loosening (one-way and break-off screws, rivets).
- The user sets the actuating head to either horizontal or vertical operation before installation.
- This is achieved by changing the alignment of the actuating head and the upper and lower parts are then secured together using a security screw.
- The four operating directions are selected by pulling forward the clasp and turning the actuating head.

Warning

- The safety switch must not be used as a mechanical end stop.
- The interlock of the safety device is maintained on power failure only with the types SLK-FVTU... (spring-locking).
- To operate the auxiliary release, first loosen the screw and turn the actuating lever.
- To maintain the safety level, the safety switch may only be used in conjunction with the corresponding actuator.

Article designation systematic for BERNSTEIN SLK safety switches

Switch	Locking principle	Actuating device	Operating voltage	Contact assembly (two-digit code) 1st. digit = Protective equipment 2nd. digit = Interlock	Auxiliary release function	Additional function
SLK	F Spring force M Magnet force	VTU	24UC 24-230MC	0 = free 1 = 1NC ⊕ 2 = 2NC ⊕ 3 = 1NO 4 = 2NO 5 = 1NC ⊕/1NO 6 = 1NC ⊕/2NO 7 = 2NC ⊕/1NO 8 = 3NC ⊕ 9 = 4NC ⊕	AR Auxiliary release	L LED R Radius actuator S Plug-in connector A Adaptor X Special design

Example: SLK FVTU24UC-55-ARR = F-TYPE, 24 V AC/DC, 1 NC ⊕ 1 NO on the interlock
1 NC ⊕ 1 NO on the safety equipment, auxiliary release, radial actuator

Programme of standard types

Part number	Designation	Locking Spring force Magnet force	Connection assembly		Control voltage	Add. functions		Actuator Standard Radius actuator
			Safety equipment	Locking		Auxiliary release (AR)	LED (L)	
601.8119.001	SLK-FVTU24UC-55-AR	Spring force	1NC ⊕ 1NO	1NC ⊕ 1NO	24 V AC/DC	AR	-	Standard
601.8119.002	SLK-FVTU24-230MC-55-AR	Spring force	1NC ⊕ 1NO	1NC ⊕ 1NO	24-48 V DC + 24-230 V AC	AR	-	Standard
601.8119.003	SLK-MVTU24UC-55	Magnet force	1NC ⊕ 1NO	1NC ⊕ 1NO	24 V AC/DC	-	-	Standard
601.8119.004	SLK-MVTU24-230MC-55	Magnet force	1NC ⊕ 1NO	1NC ⊕ 1NO	24-48 V DC + 24-230 V AC	-	-	Standard
601.8169.005	SLK-FVTU24UC-21-AR	Spring force	2NC ⊕	1NC ⊕	24 V AC/DC	AR	-	Standard
601.8169.006	SLK-FVTU24-230MC-21-AR	Spring force	2NC ⊕	1NC ⊕	24-48 V DC + 24-230 V AC	AR	-	Standard
601.8119.009	SLK-FVTU24UC-55-ARL	Spring force	1NC ⊕ 1NO	1NC ⊕ 1NO	24 V AC/DC	AR	L	Standard
601.8169.010	SLK-FVTU24UC-21-ARL	Spring force	2NC ⊕	1NC ⊕	24 V AC/DC	AR	L	Standard
601.8119.012	SLK-FVTU24-230MC-55-ARL	Spring force	1NC ⊕ 1NO	1NC ⊕ 1NO	24-48 V DC + 24-230 V AC	AR	L	Standard
601.8169.013	SLK-FVTU24-230MC-21-ARL	Spring force	2NC ⊕	1NC ⊕	24-48 V DC + 24-230 V AC	AR	L	Standard
601.8119.015	SLK-FVTU24UC-55-ARR	Spring force	1NC ⊕ 1NO	1NC ⊕ 1NO	24 V AC/DC	AR	-	Radius actuator
601.8169.016	SLK-FVTU24UC-21-ARR	Spring force	2NC ⊕	1NC ⊕	24 V AC/DC	AR	-	Radius actuator
601.8119.018	SLK-FVTU24-230MC-55-ARR	Spring force	1NC ⊕ 1NO	1NC ⊕ 1NO	24-48 V DC + 24-230 V AC	AR	-	Radius actuator
601.8169.019	SLK-FVTU24-230MC-21-ARR	Spring force	2NC ⊕	1NC ⊕	24-48 V DC + 24-230 V AC	AR	-	Radius actuator
601.8119.021	SLK-MVTU24UC-55-L	Magnet force	1NC ⊕ 1NO	1NC ⊕ 1NO	24 V AC/DC	-	L	Standard
601.8169.022	SLK-MVTU24UC-21-L	Magnet force	2NC ⊕	1NC ⊕	24 V AC/DC	-	L	Standard
601.8119.024	SLK-MVTU24UC-55-R	Magnet force	1NC ⊕ 1NO	1NC ⊕ 1NO	24 V AC/DC	-	-	Radius actuator
601.8169.025	SLK-MVTU24UC-21-R	Magnet force	2NC ⊕	1NC ⊕	24 V AC/DC	-	-	Radius actuator

According to the part designation systematic, customer specific versions (i.e. different contacts) are possible

Electrical characteristics

Switching devices

Rated isolated

voltage U_i :

250 V

Application category:

AC 15 230 V/4 A

Thermal current I_{th} :

10 A

Short-circuit protection:

DIAZED -
DIN VDE 0636 Part 1
6 A/inert gL/gG

Electronic magnets

Duration of current:

3.4 / 100% ED

Temperature class:

E (120 °C)

Pulse power:

56 VA (0.2 s)

Holding power:

1.1 VA (constant)

Switching frequency:

600 / h max.

Mechanical characteristics

Enclosure:

PA 6 GV (UL94-V0)

Lid:

PA 6 GV (UL94-V0)

Actuating device:

PA 6 GV / GD

Separate actuator:

St/PA

Ambient temperature:

-25 °C to + 70 °C

Switching function:

2 NC; 2 NO z. B.

Switching principal:

4 push-button devices

Mechanical life:

1 million cycles

Actuating radius:

R = 400 mm min.

Approach speed:

V = 0.5 m/s max.

Mounting:

4 x M5 screws

Connection cross section:

1.5 mm² flex. max.

Connection type:

cage clamp

Cable inlets:

3x Pg 13.5

Weight:

approx. 0.3 kg

Protection class:

IP 67

Mounting position:

variable

Locking:

Spring force or magnet force

Locking force:

1 000 N

Isolated:

☐