

Description : **T-1½(5mm) Lead-free Wedge base lamp 24V 1W**

Dimensional Characteristics : All dimensions in mm

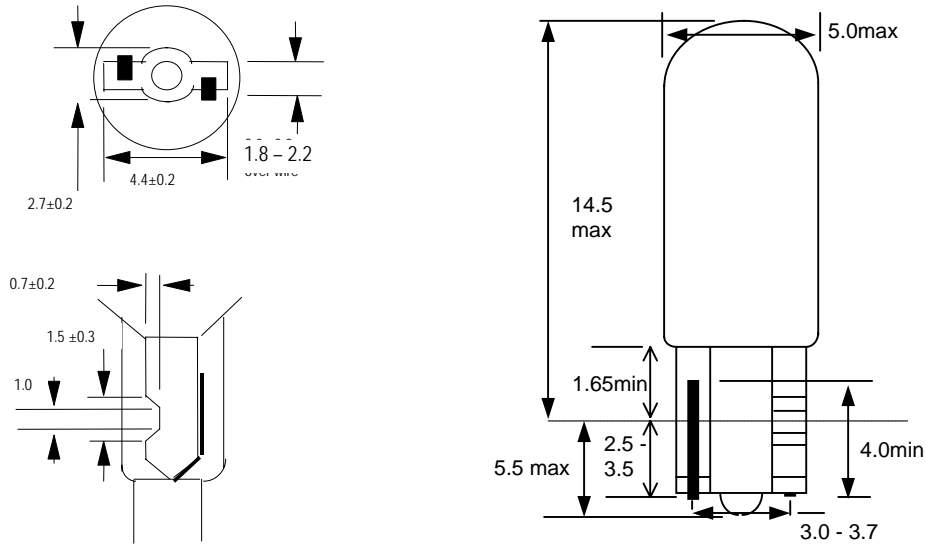

Marking

CML 24V 1W

Performance Characteristics @ 24 volts

	Nom	Min	Max
Current(mA)	40	36	44
Light output(Lm)	3.0	2.25	3.75
Life(hrs)	10,000		