

Part Number: KTIR0721DS

### \*Features

- Compact and thin.
- Visible light cut-off type.
- High sensitivity.
- Package: 1000pcs/Reel.
- RoHS Compliant.

### \*Applications

- Cassette tape recorders, VCRs.
- Floppy disk drives.
- Various microcomputerized control equipment.

### Package Dimensions

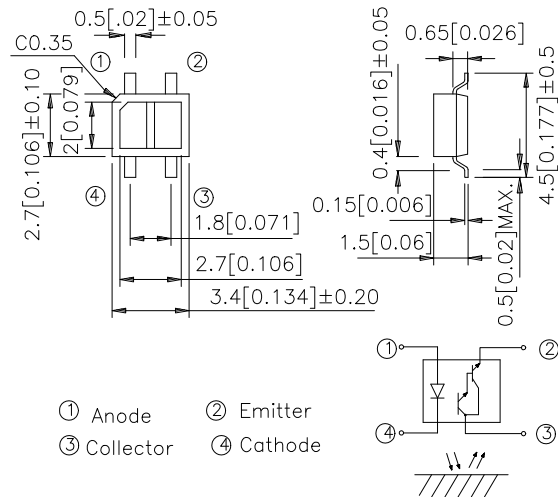

#### Notes:

1. All dimensions are in millimeters (inches).
2. Tolerance is  $\pm 0.25(0.01")$  unless otherwise noted.
3. Lead spacing is measured where the leads emerge from the package.
4. The specifications, characteristics and technical data described in the datasheet are subject to change without prior notice.

### \*Absolute Maximum Ratings $T_a=25^\circ\text{C}$

Parameter		Symbol	Rating	Unit
Input	Forward current	$I_F$	50	mA
	Reverse voltage	$V_R$	6	V
	Power dissipation	PD	75	mW
	Peak Forward Current (Pulse Width $\leq 100\mu\text{s}$ , Duty Cycle = 1%)	$I_{FP}$	1	A
Output	Collector-emitter voltage	$V_{CEO}$	35	V
	Emitter-collector voltage	$V_{ECO}$	6	V
	Collector current	$I_C$	50	mA
	Collector power dissipation	$P_C$	75	mW
Operating temperature		$T_{opr}$	-25~+85	$^\circ\text{C}$
Storage temperature		$T_{stg}$	-40~+100	$^\circ\text{C}$
soldering temperature (1/16 inch from body for 5 seconds)		$T_{sol}$	260	$^\circ\text{C}$



### Electro-optical Characteristics

Parameter		Symbol	Conditions	Min.	TYP.	Max.	Unit	
Input	Forward Voltage	$V_F$	$I_F=20\text{mA}$	1.0	1.2	1.5	V	
	Reverse Current	$I_R$	$V_R=6\text{V}$	-	-	10	$\mu\text{A}$	
	Peak Wavelength	$\lambda_P$	$I_F=20\text{mA}$	-	940	-	nm	
Output	Collector Dark Current	$I_{CEO}$	$V_{CE}=10\text{V}$ $I_F=0\text{mA}$	-	-	$10^{-6}$	A	
Transfer characteristics	*1 Collector Current	$I_C$	$V_{CE}=2\text{V}$ $I_F=4\text{mA}$	-	3	-	mA	
	*2 Leak Current	$I_{LEAK}$	$V_{CE}=5\text{V}$ $I_F=4\text{mA}$	-	-	5	$\mu\text{A}$	
	Response time	Rise time	$t_r$	$V_{CE}=2\text{V}$ $I_C=10\text{mA}$ $R_L=100\Omega, d=1\text{mm}$	-	80	400	$\mu\text{sec}$
		Fall time	$t_f$		-	70	400	$\mu\text{sec}$

\*1 The condition and arrangement of the reflective object are shown below.

\*2 Without reflective object.

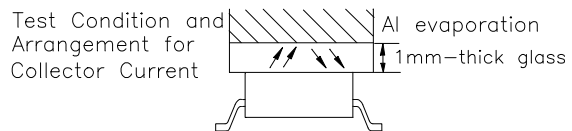

Fig. 1 Forward Current vs. Forward Voltage

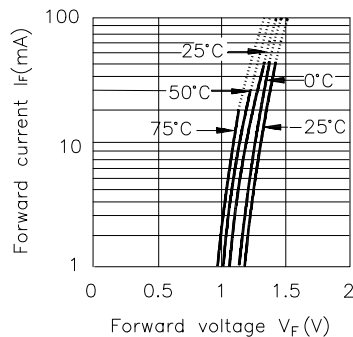

Fig. 2 Collector Current vs. Forward Current

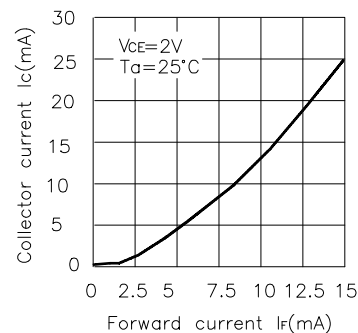

Fig. 3 Collector Current vs. Collector-emitter Voltage

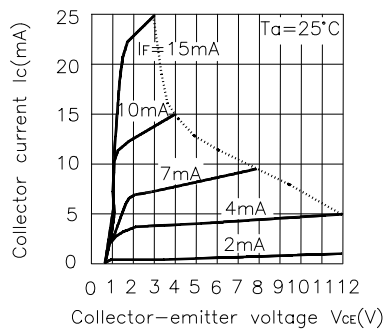

Fig. 4 Relative Collector Current vs. Ambient Temperature

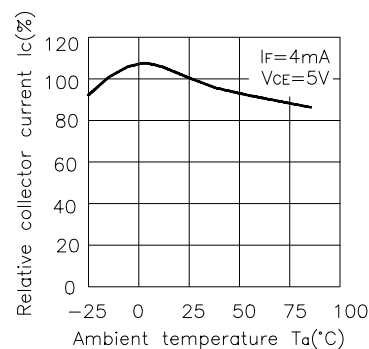
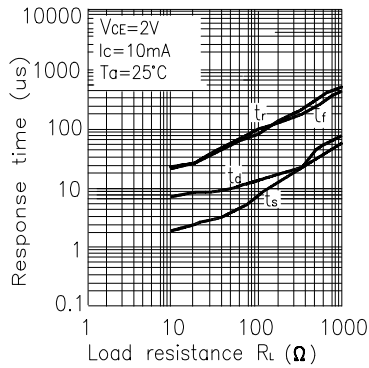

Fig. 5 Response Time vs. Load Resistance



Test Circuit for Response Time

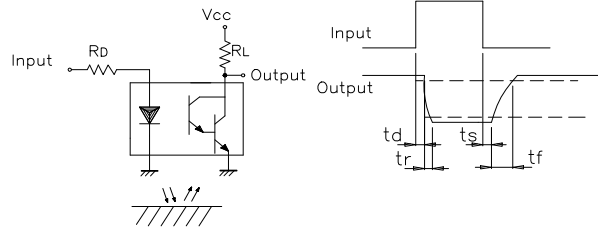

Fig. 6 Collector Dark Current vs. Ambient Temperature

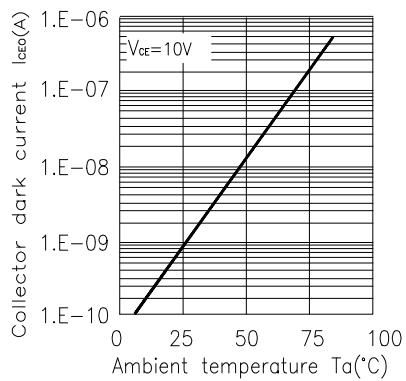

Fig. 7 Relative Collector Current vs. Distance between Sensor and Al Evaporation Glass

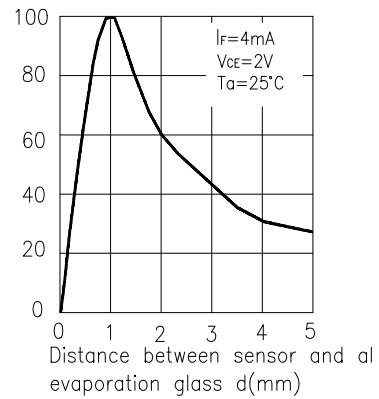

Fig. 8 Relative Collector Current vs. Card Moving Distance (1)

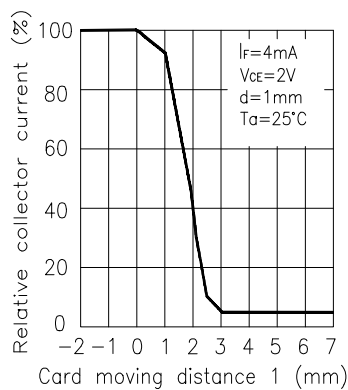
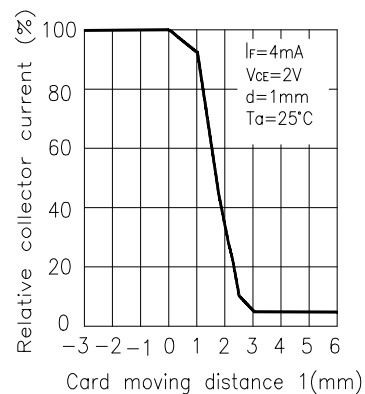
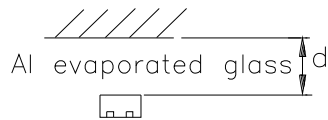

Fig. 9 Relative Collector Current vs. Card Moving Distance (2)



### Test Condition for Distance & Detecting Position Characteristics

Correpond to Fig. 7



Correpond to Fig. 8  
Test condition

$I_F = 4\text{mA}$   
 $V_{CE} = 2\text{V}$   
 $d = 1\text{mm}$

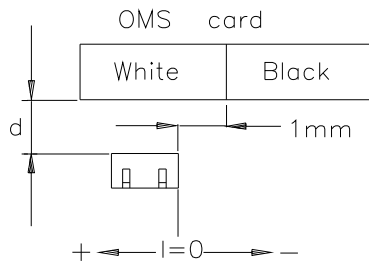

Correpond to Fig. 9  
Test condition

$I_F = 4\text{mA}$   
 $V_{CE} = 2\text{V}$   
 $d = 1\text{mm}$

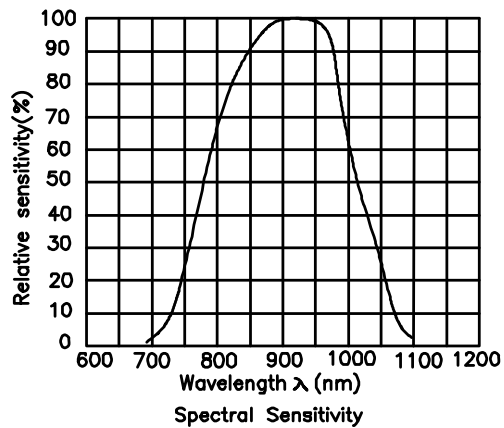
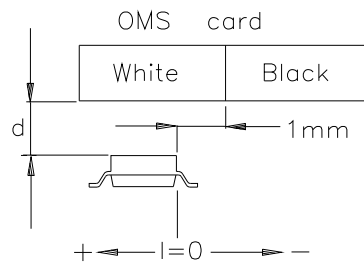

KTIR0721DS

Reflow Soldering Profile For Lead-free SMT Process.

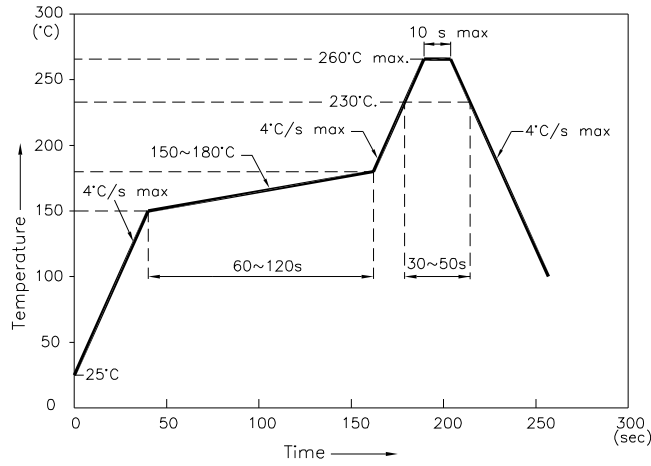

NOTES:

1. We recommend the reflow temperature 245°C(+/-5°C). The maximum soldering temperature should be limited to 260°C.
2. Don't cause stress to the epoxy resin while it is exposed to high temperature.
3. Number of reflow process shall be 2 times or less.

**Recommended Soldering Pattern**  
(Units : mm; Tolerance: ±0.1)

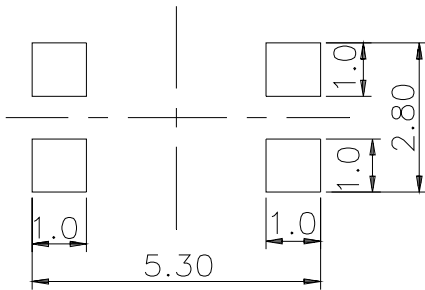

**Reel Dimension**

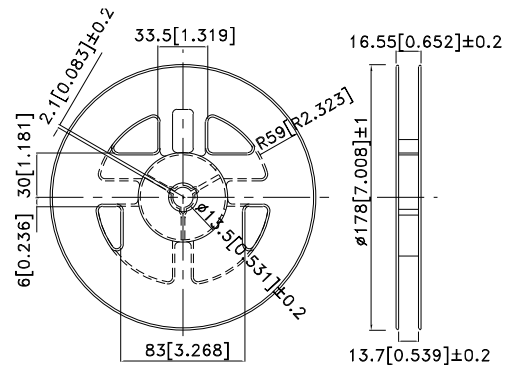

**Tape Specifications**  
(Units : mm)

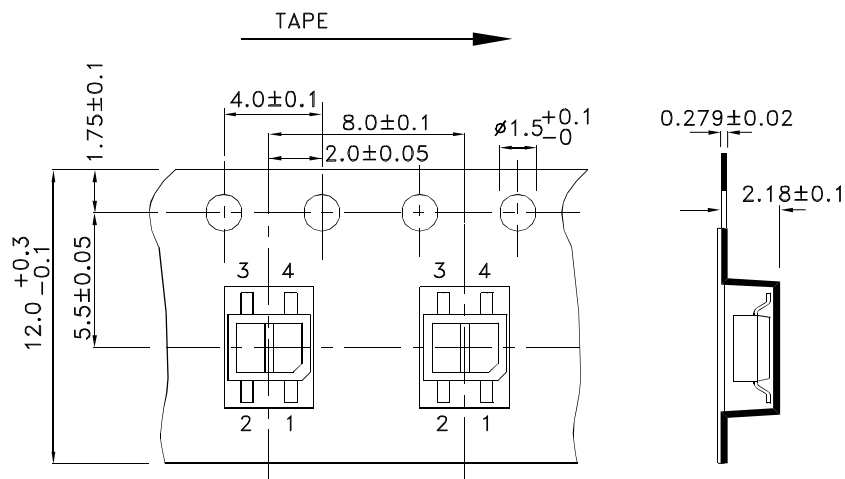

### PACKING & LABEL SPECIFICATIONS

KTIR0721DS

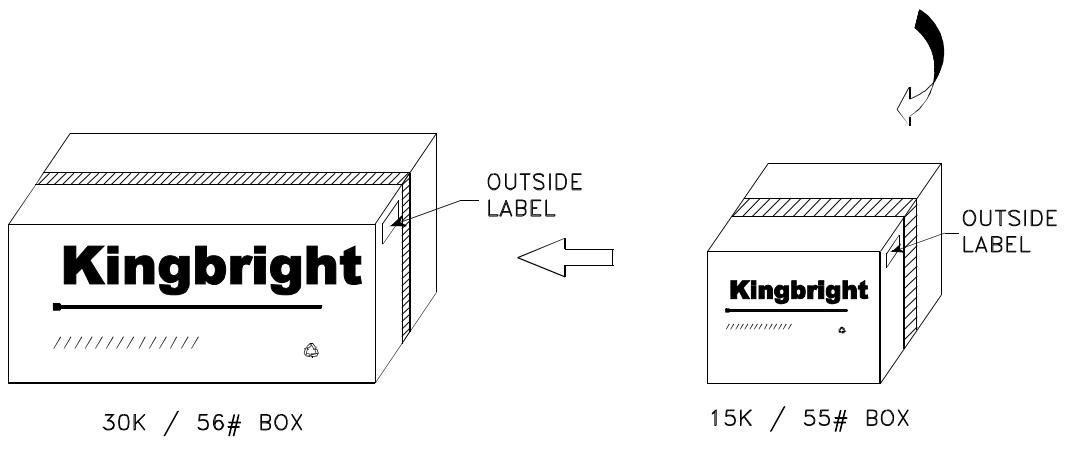
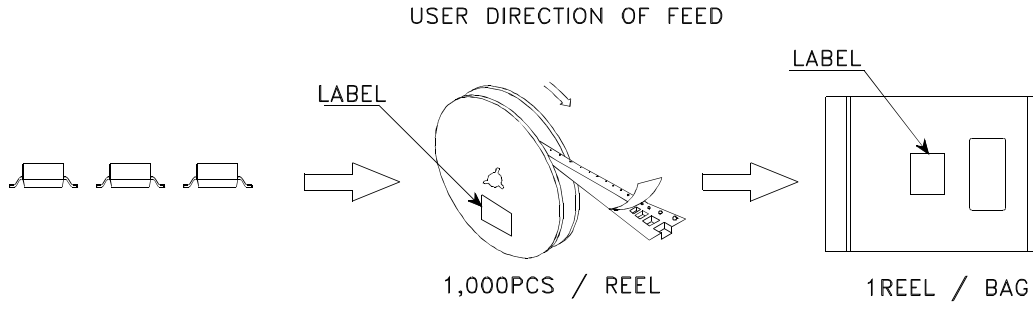

<h1>Kingbright</h1>				
P/NO: KTIRXXX				
QTY: 1,000 pcs	Q.C.			
S/N: XXXX	<table border="1"> <tr> <td>Q C</td> </tr> <tr> <td>xx xx xxxx</td> </tr> <tr> <td>PASSED</td> </tr> </table>	Q C	xx xx xxxx	PASSED
Q C				
xx xx xxxx				
PASSED				
CODE: XXX				
LOT NO:				
XXXXXXXXXXXXXXXXXX				
RoHS Compliant				