

Features 200% Peak Power!

- ◆ 3-phase input 3AC 400V or 3AC 500V
- ◆ 200 % boost power for up to 5 seconds
- ◆ Alternative to AC transformers
- ◆ Fully regulated 24 VDC output with 10 A, 20 A or 40 A
- ◆ Rugged metal case design qualified for harsh industrial environment
- ◆ High efficiency >92%
- ◆ Operating temperature range: -25°C to +60°C (full power)
- ◆ Overload and over temperature protection
- ◆ Industrial safety approvals
- ◆ Cost effective design
- ◆ 3-year product warranty



The TRACOPOWER TSP-3P series of high performance DIN-rail power supplies offers an economical solution to generate a regulated DC voltage from three-phase mains networks. The smart design achieves a very high efficiency at ultra compact size and very competitive cost. The series provides models with 240, 480 and 960 Watt output power all with additional power reserve of up to 200%. This high peak power guarantees a reliable start-up of loads with high inrush currents such as motors, valves and other industrial loads. In many applications these switching power supplies can also replace mains transformers with rectifiers.

Models

Order Code	Output Power (nom.)	Input Voltage (nom.)	Output Voltage (nom.)	*Output Current (nom.)
TSP 240-124-3PAC400	240 W	3 AC 400 V	24 VDC	10 A
TSP 240-124-3PAC500		3 AC 500 V	24 VDC	10 A
TSP 480-124-3PAC400	480 W	3 AC 400 V	24 VDC	20 A
TSP 480-124-3PAC500		3 AC 500 V	24 VDC	20 A
TSP 960-124-3PAC400	960 W	3 AC 400 V	24 VDC	40 A
TSP 960-124-3PAC500		3 AC 500 V	24 VDC	40 A

* 200% peak current for up to 5 sec.

Input Specifications

Input voltage range	400 VAC models: 320 – 440 VAC 500 VAC models: 400 – 550 VAC (derating below 410 VAC see graph 2)	star-net configuration (2-phase operation not possible)
Input voltage frequency	47 – 63 Hz	
Harmonic limits	EN 61000-3-2, Class B (for <16 A per phase)	
Power factor	>0.8 at full load	
Recommended circuit breaker,	6.0 A characteristic B	

Output Specifications

Output voltage:	24 VDC (fixed)	
Regulation	– Input / load variation	1 % max. + voltage drop at low input voltage and/or boost power, see graph 1 & 2
Boost power	– max. current – duty cycle – max. cycle time – input voltage requirements	200 % of nominal output current <10 % 5 sec limited by timer (automatic restart after 30 sec.) see graph 1 & 2
Ripple and noise (20MHz bandwidth)	– nominal operation – boost power operation	100 mV pk-pk typ. up to 750 mV pk-pk
Rise time	200 ms typ.	
Current limitation	at 230 % of nominal output current, constant current	
Oversvoltage protection	33 V typ.	
Overtemperature protection	switch off at overtemperature (automatic restart)	
Power back immunity	35 VDC continuous, 40 VDC for one second	

Output Power Derating

Graph 1: 400 VAC input models

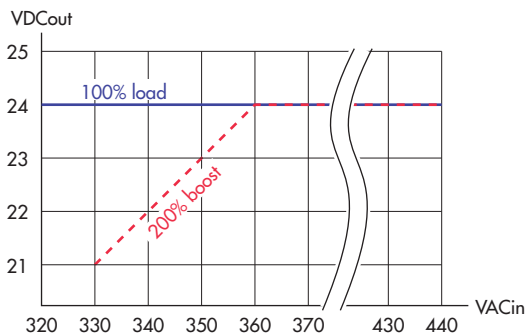

Graph 2: 500 VAC input models

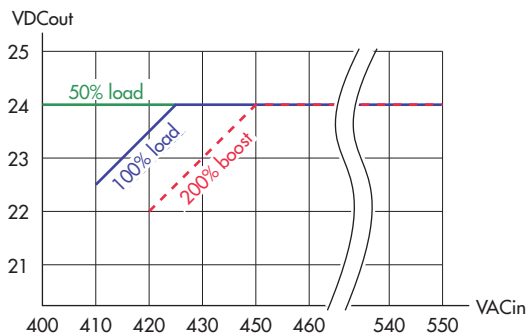

General Specifications

Temperature range	– Full power operation – Max. operating – Start up – In accordance to UL508	–25°C to +60°C +70°C, 2.5 %/K derating above +60°C –40°C –25°C to +40°C
Cooling	convection cooling, no internal fan	
Humidity (non condensing)	95 % rel. H max.	
Reliability, calculated MTBF	tba.	
Isolation	according to IEC/EN 60950-1, UL 60950-1, UL 508	
Class of protection	safety class I (IEC 536)	
Degree of protection	IP 20 (IEC/EN 60529)	

Outline Dimensions

240 Watt models

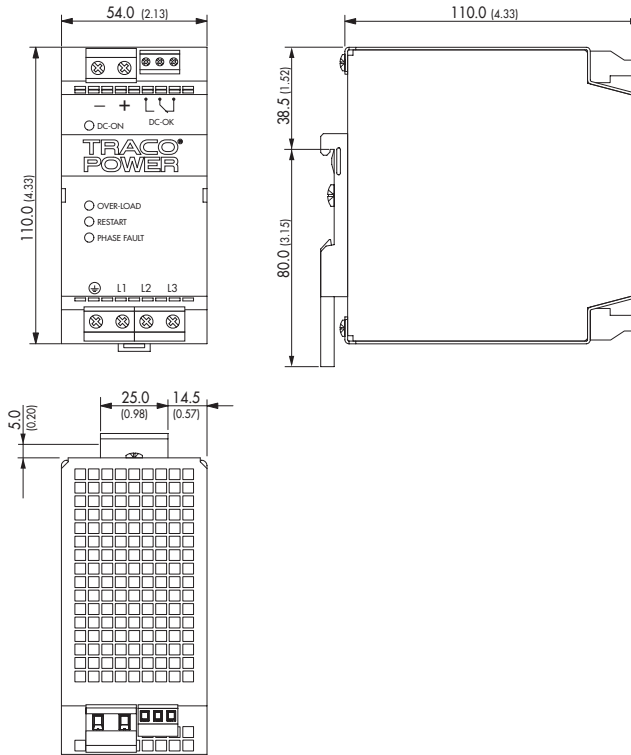

Weight: 575 g (1.27 lb)

480 Watt models

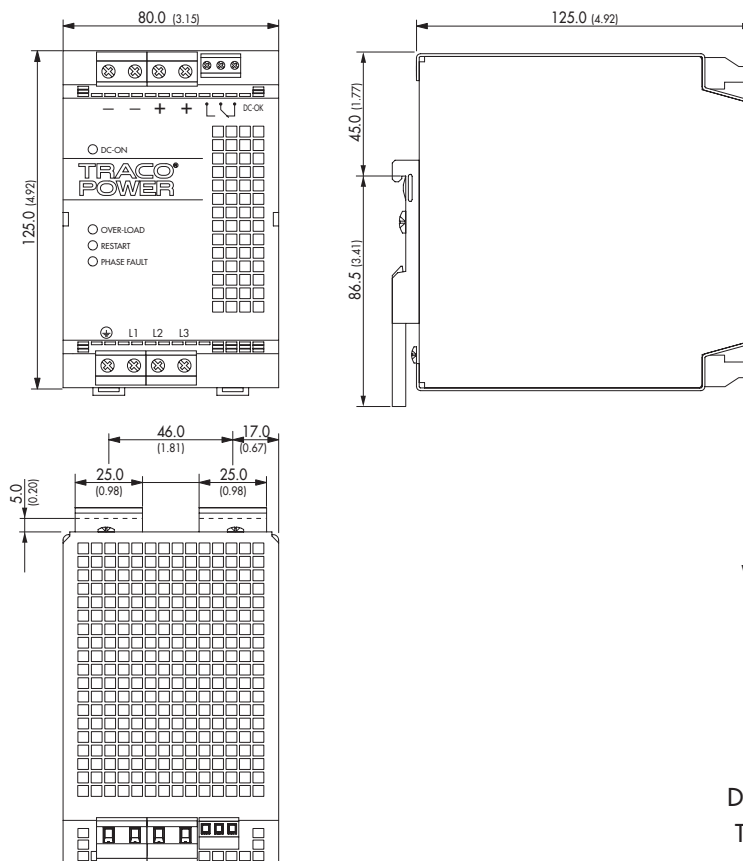

Weight: 1.05 kg (2.31 lb)

Dimensions in [mm], () = Inch
Tolerances: ±0.5 mm (±0.02)

Outline Dimensions

960 Watt models

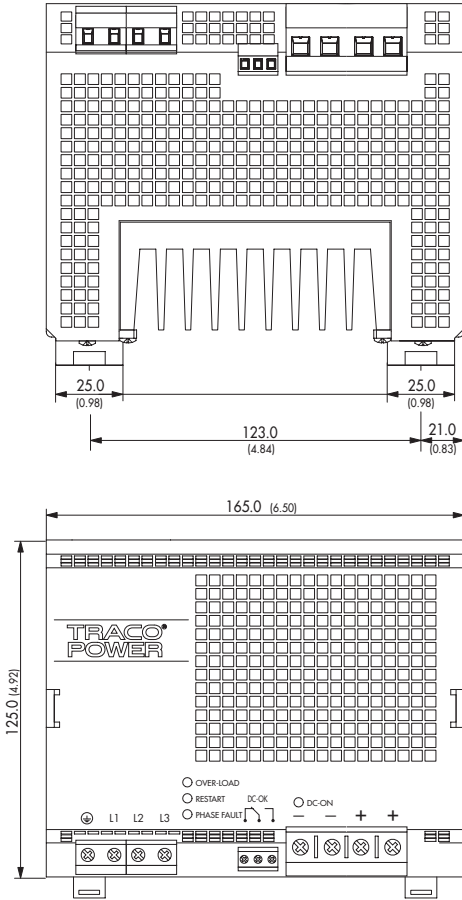

Weight: 2.35 kg (5.19 lb)

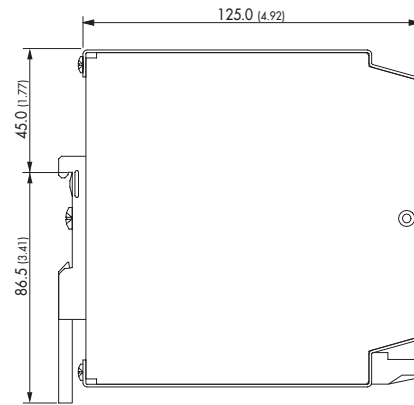

Dimensions in [mm], () = Inch
Tolerances: ±0.5 mm (±0.02)

TSP-WMK Wall Mounting Bracket

Order code	For models	Content of kit
TSP-WMK03	240 W	1 bracket
TSP-WMK02	480 W & 960 W	2 brackets

TSP-WMK03

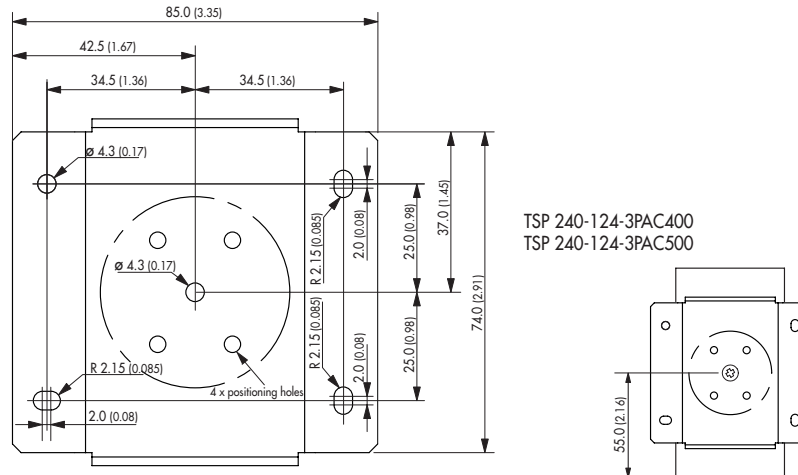

TSP-WMK02

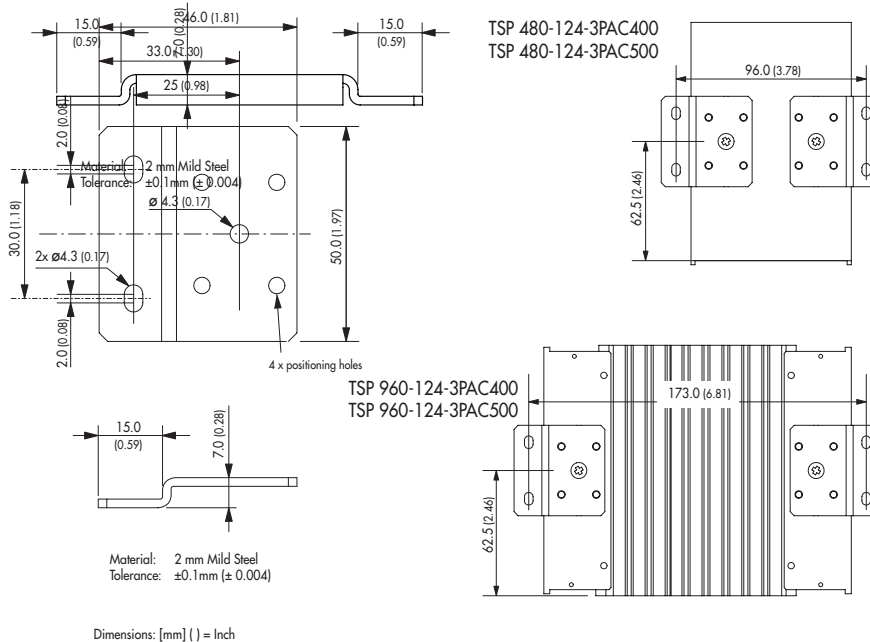

Specifications can be changed any time without notice.