

IEC Appliance Inlet C14 with Filter 2-Stage, Fuseholder 2-pole, Line Switch 2-pole

Standard- or Medical-Filter



C14

 70° C



Description

- Panel Mount:
Screw-on mounting from front side
- 4 Functions:
Appliance Inlet Protection class I, Fuseholder for fuse-links 5 x 20 mm 2-pole, Line Switch 2-pole, Line filter in standard and medical version, 2 positions
- Quick connect terminals 6.3 x 0.8 mm

Approvals

- VDE Certificate Number: 40004665
- UL File Number: E72928

Characteristics

- Compact design with optimal shielding
- All single elements are already wired
- Plug removal necessary for fuse-link replacement
If the power entry module is installed as normal, it is not possible to touch any live parts with the test-finger according to IEC60529
Fuse drawer meets requirements of medical standard IEC/EN 60601-1
The fuseholder is accessible from the equipment front
- 2-stage line filter with increased attenuation
With EMC-shield
- Qualified for use in equipment according IEC/EN 60950

Other versions on request

- Medical version M80

References

Weblinks

[pdf](#), [html](#), [General Product Information](#), [Approvals](#), [RoHS](#), [CHINA-RoHS](#), [Mating Connectors](#), [e-Store](#), [SCHURTER-Stock-Check](#), [Distributor-Stock-Check](#), [Accessories](#)

Technical Data

Ratings IEC	1 - 10A @ Ta 40 °C / 250VAC; 50Hz	Appliance-Inlet/-Outlet	C14 acc. to IEC/EN 60320-1, UL 498, CSA C22.2 no. 42 (for cold conditions) pin-temperature 70 °C, 10A, Protection Class 1
Ratings UL/CSA	1 - 10A @ Ta 40 °C / 125VAC; 60Hz	Fuseholder	2-pole, Shocksafe category PC2 acc. to IEC 60127-6, for fuse-links 5 x 20mm
Leakage Current	standard < 0.25mA (250V / 60Hz) medical < 5 µA (250 V / 60 Hz)	Rated Power Acceptance @ Ta 23 °C	5 x 20: 1.6W (2-pole)
Dielectric Strength	> 1.7kVDC between L-N > 2.7kVDC between L/N-PE Test voltage (2 sec)	Power Acceptance @ Ta > 23°C	Admissible power acceptance at higher ambient temperature see derating curves
Allowable Operation Temp.	-25°C to 85°C	Line Switch	Rocker switch 2-pole, non-illuminated, acc. to IEC 61058-1 Technical details
Climatic Category	25/085/21 acc. to IEC 60068-1	Line Filter	Standard and Medical Version, IEC 60939, IEC 60601-1, UL 1283, UL 544, EN 133 200, CSA C22.2 no. 8 Technical details
Degree of Protection	from front side IP 40 acc. to IEC 60529	MTBF	> 1'200'000h acc. to MIL-HB-217 F
Protection Class	Suitable for appliances with protection class 1 acc. to IEC 61140		
Terminal	Quick connect terminals 6.3 x 0.8 mm		
Panel Thickness s	Screw: max 8 mm Mounting screw torque max 0.5Nm		
Material: Housing	Thermoplastic, black, UL 94V-0		

Dimensions

Case 45

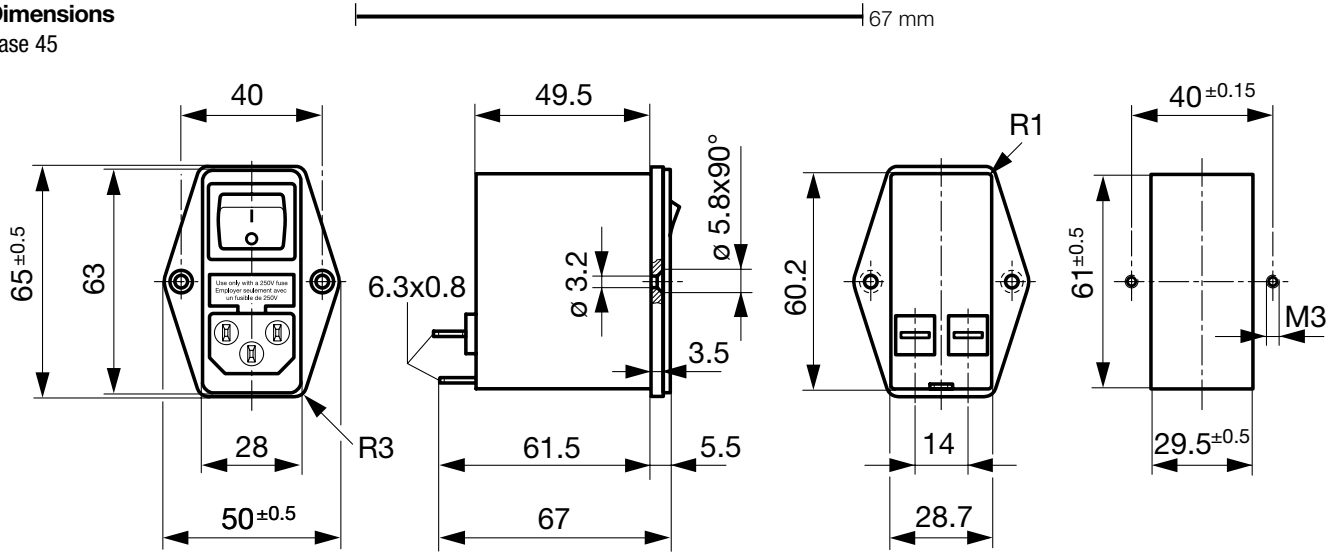

Technical Data of Filter-Components

Rated Current [A]	Filter-Type	Inductances L [mH]	Capacitance CX [nF]	Capacity Cy1 [nF]	Capacity Cy2 [nF]	R [MΩ]
1	Standard Version	2 x 10	68	1.5	1	1
2	Standard Version	2 x 4	68	1.5	1	1
4	Standard Version	2 x 1.5	68	1.5	1	1
6	Standard Version	2 x 0.8	68	1.5	1	1
10	Standard Version	2 x 0.3	68	1.5	1	1
1	Medical Version (M5)	2 x 10	68	-	-	1
2	Medical Version (M5)	2 x 4	68	-	-	1
4	Medical Version (M5)	2 x 1.5	68	-	-	1
6	Medical Version (M5)	2 x 0.8	68	-	-	1
10	Medical Version (M5)	2 x 0.3	68	-	-	1

Diagrams

Standard version

Medical version

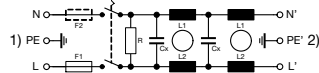
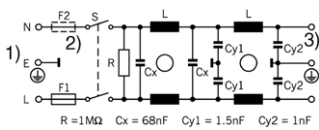

- 1) Line
- 2) only FKID
- 3) Load

- 1) Line
- 2) Load

Derating Curves

2-pole

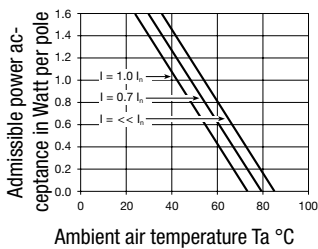

Attenuation Loss

----- differential mode _____ common mode

Standard version

1 A

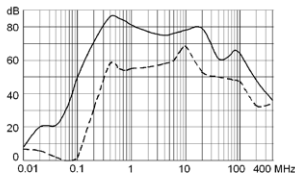

2 A

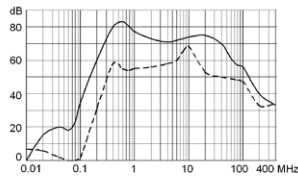

4 A

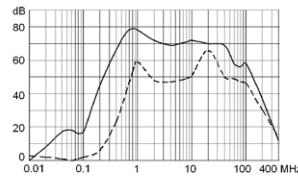

6 A

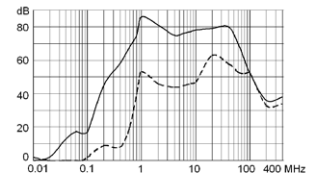

10 A

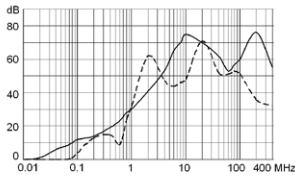

Medical version (M5)

1 A

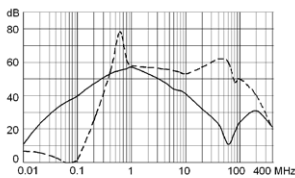

2 A

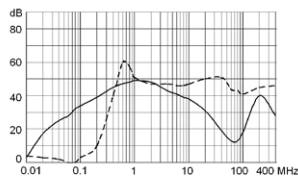

4 A

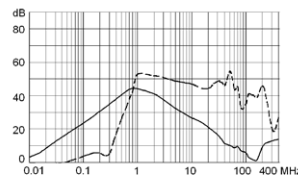

6 A

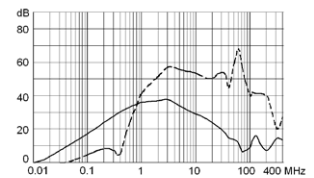

10 A

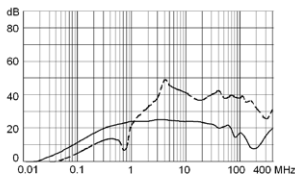

Variants

Socket and fuse drawer included

Type	Rated Current [A]	Filter-Type	Fuseholder	Line Switch	Housing	Material: Housing	Comment	Order Number
FKID	1	Standard Version	2-pole	2-pole	45	Aluminum	-	4304.5061
FKID	2	Standard Version	2-pole	2-pole	45	Aluminum	-	4304.5062
FKID	4	Standard Version	2-pole	2-pole	45	Aluminum	-	4304.5063
FKID	6	Standard Version	2-pole	2-pole	45	Aluminum	-	4304.5064
FKID	10	Standard Version	2-pole	2-pole	45	Aluminum	-	4304.5065
FKID	1	Medical Version (M5)	2-pole	2-pole	45	Aluminum	-	4304.5081
FKID	2	Medical Version (M5)	2-pole	2-pole	45	Aluminum	-	4304.5082
FKID	4	Medical Version (M5)	2-pole	2-pole	45	Aluminum	-	4304.5083
FKID	6	Medical Version (M5)	2-pole	2-pole	45	Aluminum	-	4304.5084
FKID	10	Medical Version (M5)	2-pole	2-pole	45	Aluminum	-	4304.5085
FKID	1	Standard Version	2-pole	2-pole	45	Nickel plated steel	-	4304.5021
FKID	2	Standard Version	2-pole	2-pole	45	Nickel plated steel	-	4304.5022
FKID	4	Standard Version	2-pole	2-pole	45	Nickel plated steel	-	4304.5023
FKID	6	Standard Version	2-pole	2-pole	45	Nickel plated steel	-	4304.5024
FKID	10	Standard Version	2-pole	2-pole	45	Nickel plated steel	-	4304.5025
FKID	2	Medical Version (M5)	2-pole	2-pole	45	Nickel plated steel	-	4304.5067

Packaging unit 10 Pcs

Accessories

Description

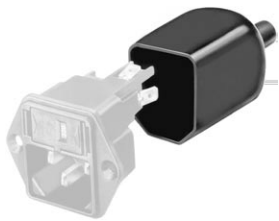

Assorted Covers
Rear Cover

Mating Outlets/Connectors

Category / Description

Appliance Outlet Overview complete



IEC Appliance Outlet F, Screw-on Mounting, Front Side, Solder Terminal	4787
IEC Appliance Outlet F, Snap-in Mounting, Front Side, Solder or Quick-connect Terminal	4788
IEC Appliance Outlet F or H, Screw-on Mounting, Front Side, Solder, PCB or Quick-connect Terminal	5091
IEC Appliance Outlet F or H, Screw-on Mounting, Front Side, Solder or Quick-connect Terminal	5092

[Appliance Outlet further types to FKID](#)

Connector Overview complete



IEC Connector C15, Rewireable, Straight	0101
IEC Connector C15A, Rewireable, Straight	0102
IEC Connector C15A, Rewireable, Straight	0102-G
IEC Connector C15A, Rewireable, Angled	0112
IEC Connector C13, Rewireable, Angled	4012

[Connector further types to FKID](#)

Power Cord Overview complete



Power Cord with IEC Connector C13, Angled	0311
Power Cord with IEC Connector C13, Angled	3011
Power Cord with IEC Connector C13, Angled	3012
Power Cord with IEC Connector C13, Angled	3013
Power Cord with IEC Connector C13	3020

[Power Cord further types to FKID](#)