



**Muffin XL AC - MX3B1 - 028421**  
 (Family) (Model) (Part Number)

## Electrical Specifications

Rated Voltage:	230 VAC
AC Frequency:	60 Hz
Power Supply:	16.0 Watts
Line Current:	0.09 Amps
Locked Rotor Current	0.14 Amps
Nominal Speed:	3100 RPM

## Mechanical Specifications

Dimensions:	4.72in x 1.50in
Weight	21.0 oz
Max Airflow @ 0 in H <sub>2</sub> O	105.0 CFM
Max Pressure @ 0 CFM	0.223 in H <sub>2</sub> O
Noise	47.6 dBA



Comair Rotron, Inc.  
 Phone: 858.348.6200  
 sales@comairrotron.com

Comair Rotron Europe, Ltd.  
 Phone: +44.1527.520525  
 saleseurope@comairrotron.com

Comair Rotron Fan Company Ltd.  
 Phone: +86.21.52260581  
 salesasia@comairrotron.com

Print Date: Monday, February 18, 2008 at 00:50:14 - AC Fan Datasheet - Web Version 1.0 Rev. A



## Mechanical Drawing

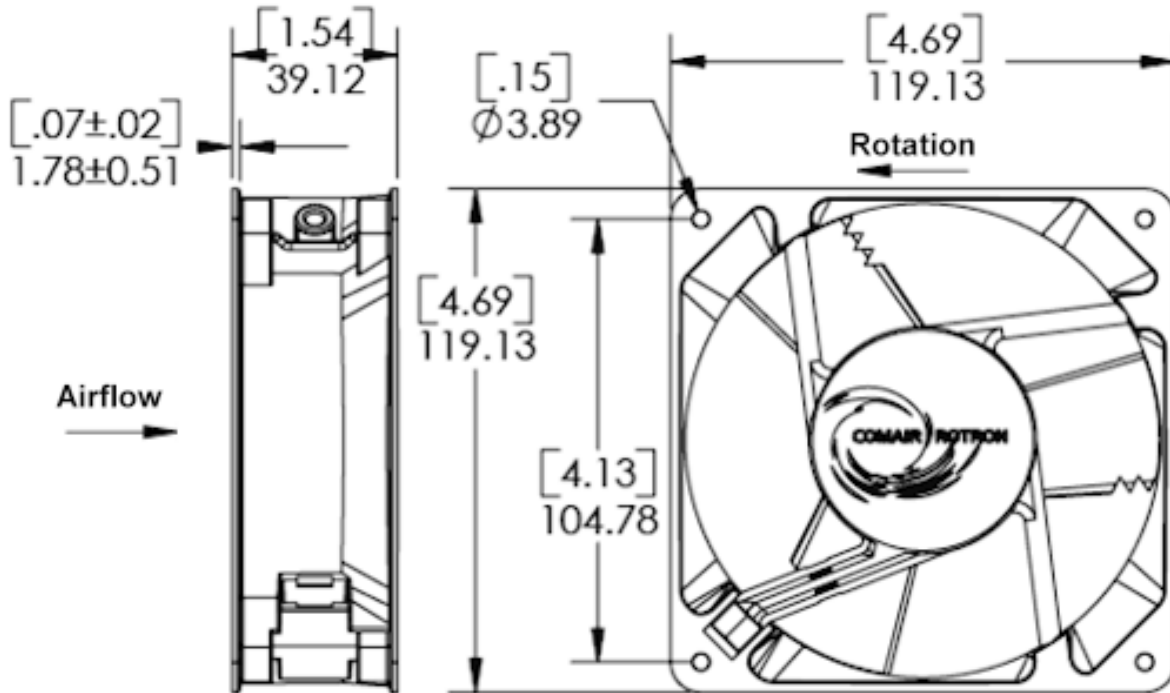

## Options

Part Number	Model Number	Bearing Type	Fan Rotation	Termination	In-Stock (Click 'Yes' for current stock)
028421	MX3B1	Ball	Normal	0.120 Terminals	No
031000	MX3B2	Ball	Normal	Leads	No
028423	MX3B3	Ball	Reverse	0.120 Terminals	No
030913	MX3B4	Ball	Reverse	Leads	No
028326	MX3A1	Sleeve	Normal	0.120 Terminals	No
028324	MX3A3	Sleeve	Reverse	0.120 Terminals	No
031003	MX3A4	Sleeve	Reverse	Leads	No

## Accessories [\(Click on part number for detailed drawing.\)](#)

**428056**  
**Plug and Cord**

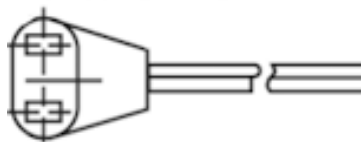

**550440**  
**Plug and Cord**

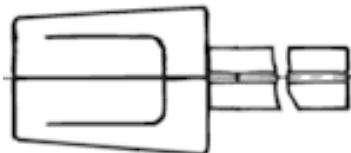

**550113**  
**Mounting Clip**



**551590**  
**Filter Assembly**

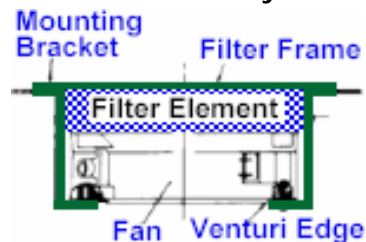

**554148**  
**Filter Guard Assembly**

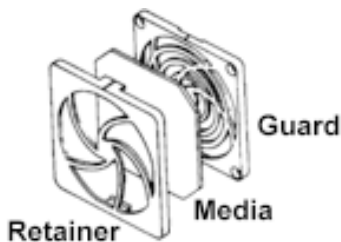

**552934**  
**Finger Guard**



**476042**  
**Finger Guard**

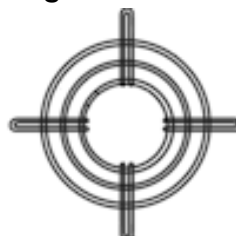

**550481**  
**Finger Guard**

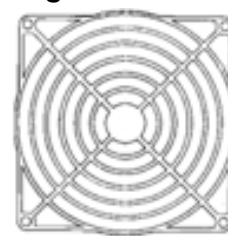

**551147**  
**Finger Guard**



**Comair Rotron, Inc.**  
Phone: 858.348.6200  
sales@comairrotron.com

**Comair Rotron Europe, Ltd.**  
Phone: +44.1527.520525  
saleseurope@comairrotron.com

**Comair Rotron Fan Company Ltd.**  
Phone: +86.21.52260581  
salesasia@comairrotron.com

Print Date: Monday, February 18, 2008 at 00:50:14 - AC Fan Datasheet - Web Version 1.0 Rev. A