

Solid State Relay



Specification Table

Control Voltage	Must Turn off Voltage	Input Impedance	Loading Current	Loading Voltage	Minimum Blocking Voltage	Maximum off-State Leakage	Frequency Range	Maximum 1-Cycle Peak Surge	Part Number
4 - 32 V dc	Maximum 1 V dc	1.5 K Ω	25 A	24 to 280 V ac	600 V ac	Less 3 mA	47-70 Hz	250 A	SDA-200B025S-1Z
			40 A					400 A	SDA-200B040S-1Z
			50 A					500 A	SDA-200B050S-1Z

Maximum off State dv / dt	Maximum on-State Voltage Drop	Isolate Impedance	Dielectric Strength Input-Output	Dielectric Strength Input, Output-case	Turn on Time	Turn off Time	Capacitance In-Out	Weight (g)	Part Number
500 V / μ s	2 V _{rms}	10 ⁹ Ω	4,000 V ac _{rms}	4,000 V ac _{rms}	Less 2 ms	Less 1/2 AC Cycle	Less 15 pF	100 g	SDA-200B025S-1Z
									SDA-200B040S-1Z
									SDA-200B050S-1Z

Characteristic Curves

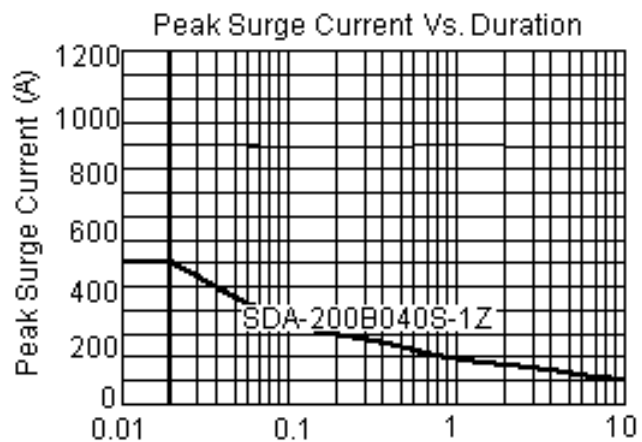
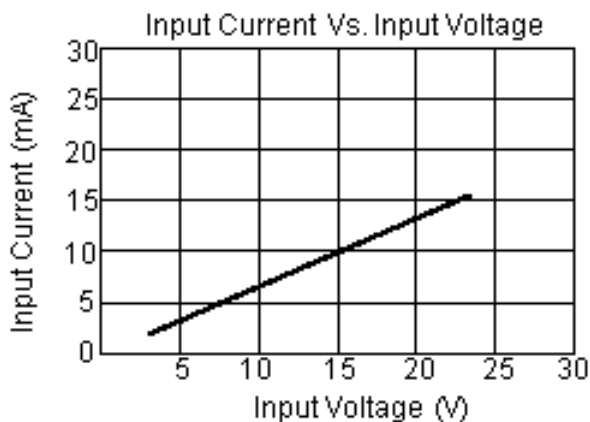

Solid State Relay

Characteristic Curves

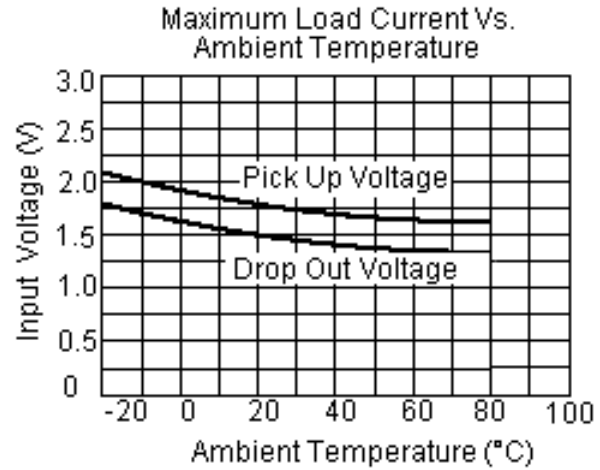
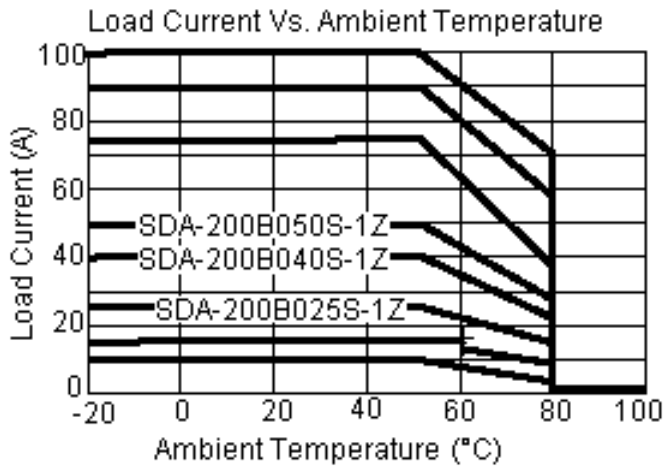

Outline Dimensions (Unit : mm)

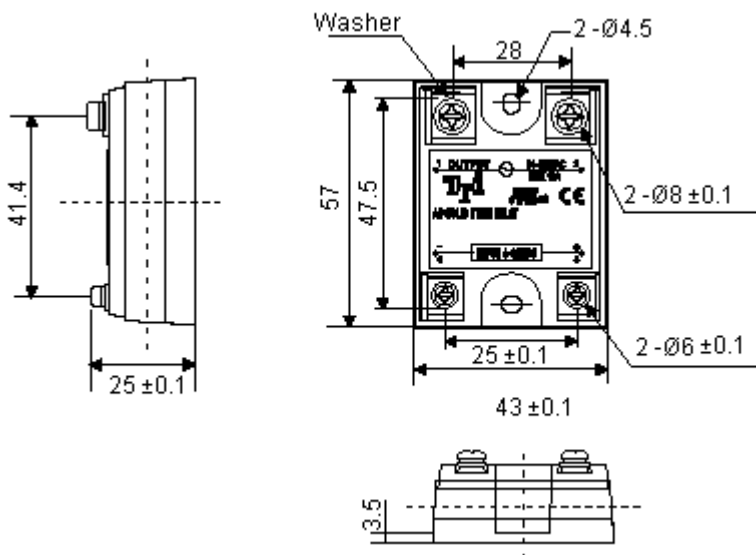

Dimensions : Millimetres

Equivalent Circuit

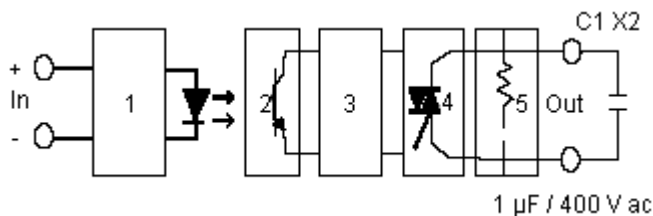

1. Input Circuit
2. Photo Detector
3. Zero-Crossing Circuit
4. Output Circuit
5. Protect Circuit

Solid State Relay



Part Number Explanation:

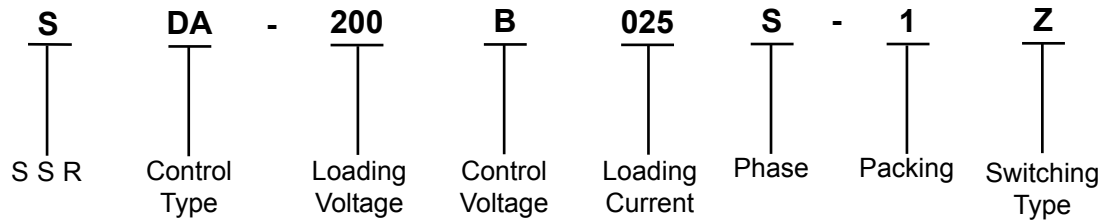

S	: S = S S R
Control Type	: DA = DC Control ac
Loading Voltage	: 200 = 24 to 280 V ac
Control Voltage	: B = 4-32 V dc
Loading Current	: 025 = 25 A, 040 = 40 A and 050 = 50 A
Phase	: S = Single phase
Packing	: 1 = Screw type
Switching Type	: Z = Zero crossing

Important Notice : This data sheet and its contents (the "Information") belong to the members of the Premier Farnell group of companies (the "Group") or are licensed to it. No licence is granted for the use of it other than for information purposes in connection with the products to which it relates. No licence of any intellectual property rights is granted. The Information is subject to change without notice and replaces all data sheets previously supplied. The Information supplied is believed to be accurate but the Group assumes no responsibility for its accuracy or completeness, any error in or omission from it or for any use made of it. Users of this data sheet should check for themselves the Information and the suitability of the products for their purpose and not make any assumptions based on information included or omitted. Liability for loss or damage resulting from any reliance on the Information or use of it (including liability resulting from negligence or where the Group was aware of the possibility of such loss or damage arising) is excluded. This will not operate to limit or restrict the Group's liability for death or personal injury resulting from its negligence. Multicomp is the registered trademark of the Group. © Premier Farnell plc 2011.