

Spezifikation für Freigabe / specification for release

Kunde / customer :
 Artikelnummer / part number : **7447053**
 Bezeichnung : **FUNKENTSTÖRDROSSEL WE-FI**
 description : **TOROIDAL LINE CHOKE WE-FI**



DATUM / DATE : 2009-12-01

A Mechanische Abmessungen / dimensions:

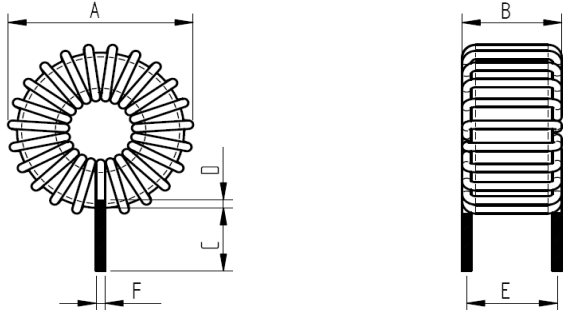

A	10,0 max	mm
B	5,0 max	mm
C	15,0 ± 2,0	mm
D	1,0 min	mm
E	4,0 ± 2,0	mm
F	ø 0,5 ref	mm

B Elektrische Eigenschaften / electrical properties:

Eigenschaften / properties	Testbedingungen / test conditions		Wert / value	Einheit / unit	tol.
Leerlauf-Induktivität / inductance	10 KHz / 5mA	L _O	12,0	µH	±20%
DC-Widerstand / DC-resistance	@ 20°C	R _{DC}	0,030	Ω	max.
Nennstrom / rated current	ΔT=40 K	I _{DC}	1,00	A	max.

C Lötpad / soldering spec.:

D Prüfgeräte / test equipment:

Wayne Kerr 3260B für/for L₀
GMC Metrahit 271 Milliohmmeter für/for R_{DC}
Fluke 54II Thermometer für/for I_{DC}

E Testbedingungen / test conditions:

Luftfeuchtigkeit / humidity: 33%
 Umgebungstemperatur / temperature: +20 °C

F Werkstoffe & Zulassungen / material & approvals:

Basismaterial / base material: Eisenpulver / Iron powder
 Draht / wire: Class F

G Eigenschaften / general specifications:

Betriebstemp. / operating temperature: -25 °C - +105 °C

Freigabe erteilt / general release:	Kunde / customer		
Datum / date	Unterschrift / signature		
Geprüft / checked	Würth Elektronik		
Kontrolliert / approved	Name	Änderung / modification	Datum / date
	CZ	Version 6	09-12-01
	CZ	Version 4	09-05-15
	MST	Version 2	04-10-11
	SST	Version 1	04-06-15

This electronic component has been designed and developed for usage in general electronic equipment. Before incorporating this component into any equipment where higher safety and reliability is especially required or if there is the possibility of direct damage or injury to human body, for example in the range of aerospace, aviation, nuclear control, submarine, transportation, (automotive control, train control, ship control), transportation signal, disaster prevention, medical, public information network etc, Würth Elektronik eiSos GmbH must be informed before the design-in stage. In addition, sufficient reliability evaluation checks for safety must be performed on every electronic component which is used in electrical circuits that require high safety and reliability functions or performance.

Würth Elektronik eiSos GmbH & Co.KG

D-74638 Waldenbug · Max-Eyth-Strasse 1 - 3 · Germany · Telefon (+49) (0) 7942 - 945 - 0 · Telefax (+49) (0) 7942 - 945 - 400
<http://www.we-online.com>