

Spezifikation für Freigabe / specification for release

Kunde / customer :

Artikelnummer / part number : **744053150**

Bezeichnung : **SPEICHERDROSSEL WE-TPC**

description : **POWER-CHOKE WE-TPC**



DATUM / DATE : 2010-08-02

A Mechanische Abmessungen / dimensions:

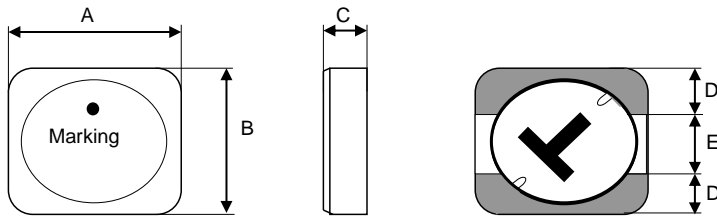

	Type 5828	
A	5,8 ± 0,3	mm
B	5,8 ± 0,3	mm
C	2,8 ± 0,2	mm
D	1,90typ.	mm
E	2,0 typ.	mm
F		
G		
H		

● = Start of winding

Marking = Inductance code

B Elektrische Eigenschaften / electrical properties:

Eigenschaften / properties	Testbedingungen / test conditions		Wert / value	Einheit / unit	tol.
Induktivität / inductance	100 kHz / 0,1V	L	15,00	μH	± 30%
DC-Widerstand / DC-resistance	@ 20°C	R _{DC typ}	0,070	Ω	typ.
DC-Widerstand / DC-resistance	@ 20°C	R _{DC max}	0,100	Ω	max.
Nennstrom / rated current	ΔT=30 K	I _{DC}	1380	mA	max.
Sättigungsstrom / saturation current	 ΔL/L <35%	I _{sat}	1150	mA	typ.
Eigenres.-Frequenz / self-res.-frequency		SRF	20,00	MHz	typ.

C Lötpad / soldering spec.:

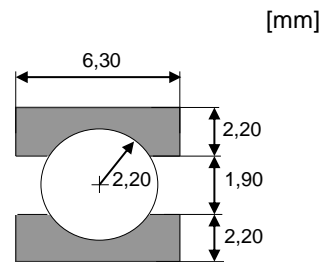

D Prüfgeräte / test equipment:

HP 4274 A für/for L und/and Q
HP 34401 A für/for R_{DC} und I_{DC}

E Testbedingungen / test conditions:

Luftfeuchtigkeit / humidity: 33%
 Umgebungstemperatur / temperature: +20°C

F Werkstoffe & Zulassungen / material & approvals:

Basismaterial / base material: Ferrit
 Draht / wire: Class H
 Endoberfläche / finishing electrode: Sn/Ag/Cu - 96.5/3.0/0.5%

G Eigenschaften / general specifications:

Betriebstemp. / operating temperature: -40°C - + 125°C
 Umgebungstemp. / ambient temperature: -40°C - + 85°C
 It is recommended that the temperature of the part does not exceed 125°C under worst case operating conditions.

Freigabe erteilt / general release:	Kunde / customer		
Datum / date	Unterschrift / signature		
Geprüft / checked	Würth Elektronik		
	Kontrolliert / approved		
	Name	Änderung / modification	Datum / date

Würth Elektronik eiSos GmbH & Co.KG

D-74638 Waldenburg · Max-Eyth-Strasse 1 - 3 · Germany · Telefon (+49) (0) 7942 - 945 - 0 · Telefax (+49) (0) 7942 - 945 - 400
<http://www.we-online.com>

Spezifikation für Freigabe / specification for release

Kunde / customer :
 Artikelnummer / part number : **744053150**
 Bezeichnung : **SPEICHERDROSSEL WE-TPC**
 description : **POWER-CHOKE WE-TPC**



DATUM / DATE : 2010-08-02

H Induktivitätskurve / Inductance curve :

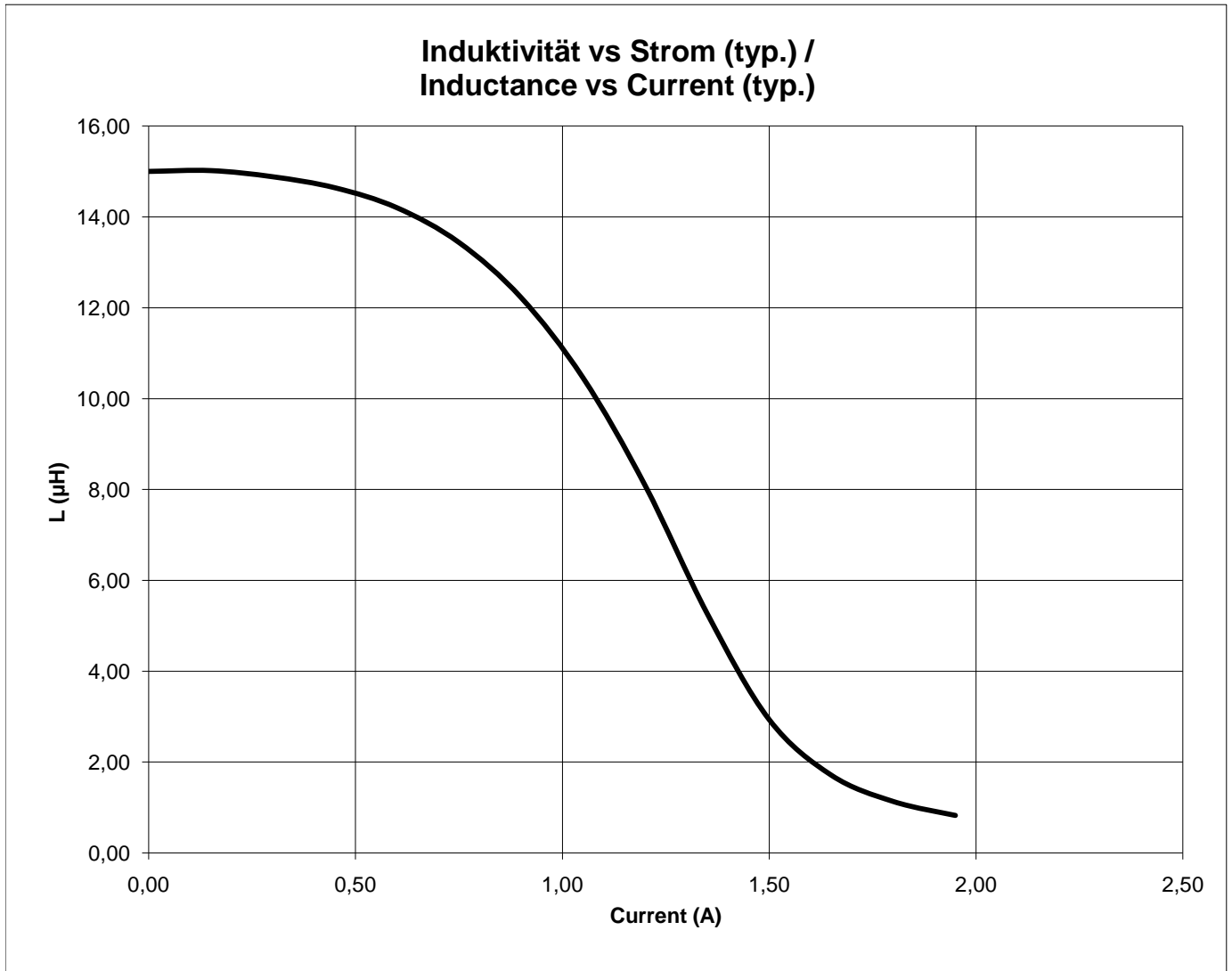

Freigabe erteilt / general release:	Kunde / customer			
Datum / date	Unterschrift / signature			
Geprüft / checked	Kontrolliert / approved			
Würth Elektronik				
		Name	Änderung / modification	Datum / date
		CZ	Version 6	10-08-02
		ME	Version 5	09-01-15
		MST	Version 4	08-04-11
		MST	Version 2	04-10-11
		MPH	Version 1	03-03-27

Würth Elektronik eiSos GmbH & Co.KG

D-74638 Waldenburg · Max-Eyth-Strasse 1 - 3 · Germany · Telefon (+49) (0) 7942 - 945 - 0 · Telefax (+49) (0) 7942 - 945 - 400
<http://www.we-online.com>

Spezifikation für Freigabe / specification for release

Kunde / customer :
 Artikelnummer / part number : **744053150**
 Bezeichnung : **SPEICHERDROSSEL WE-TPC**
 description : **POWER-CHOKE WE-TPC**



DATUM / DATE : 2010-08-02

I Rollenspezifikation / tape and reel specification:

Gurtspezifikation / Tape specification:		
A	12,0 ± 1,0	mm
B	4,00 ± 0,1	mm

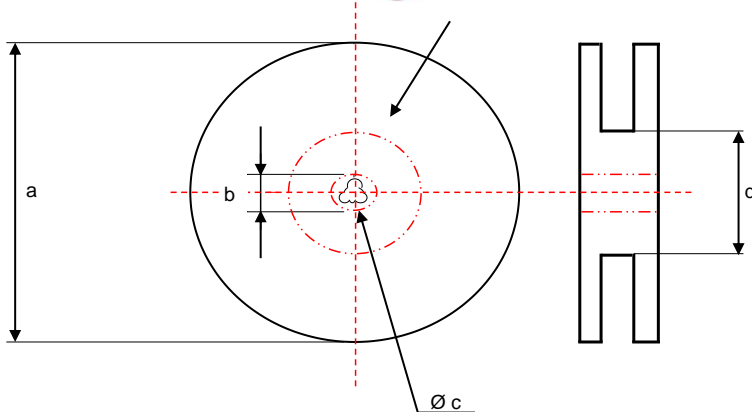

Rollenspezifikation / Reel specification:		
a	178 ± 0,5	mm
b	20,20 ± 0,1	mm
c	13,00 ± 0,5 ± 1,0	mm
d	50,0 ± 1,0	mm



The force for tearing off cover tape is 20 to 70 grams in arrow direction

Freigabe erteilt / general release:	Kunde / customer			
	Datum / date	Unterschrift / signature	CZ	Version 6
	Würth Elektronik	ME	Version 5	10-08-02
	Geprüft / checked	Kontrolliert / approved	MST	Version 4
			MST	Version 2
			MPH	Version 1
			Name	Änderung / modification
				Datum / date

This electronic component has been designed and developed for usage in general electronic equipment. Before incorporating this component into any equipment where higher safety and reliability is especially required or if there is the possibility of direct damage or injury to human body, for example in the range of aerospace, aviation, nuclear control, submarine, transportation, (automotive control, train control, ship control), transportation signal, disaster prevention, medical, public information network etc, Würth Elektronik eiSos GmbH must be informed before the design-in stage. In addition, sufficient reliability evaluation checks for safety must be performed on every electronic component which is used in electrical circuits that require high safety and reliability functions or performance.

Würth Elektronik eiSos GmbH & Co.KG

D-74638 Waldenburg · Max-Eyth-Strasse 1 - 3 · Germany · Telefon (+49) (0) 7942 - 945 - 0 · Telefax (+49) (0) 7942 - 945 - 400
<http://www.we-online.com>