

1

2

3

4

5

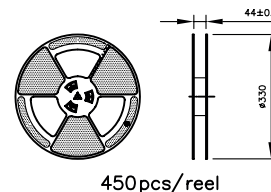
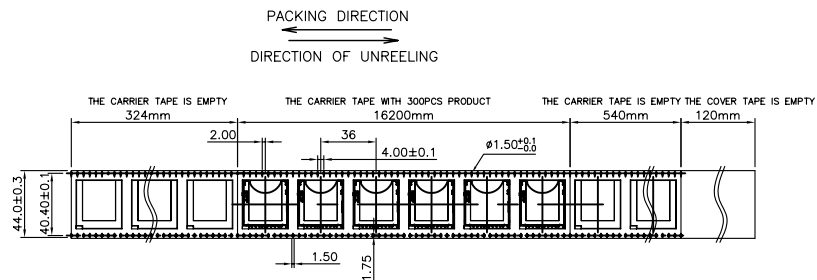
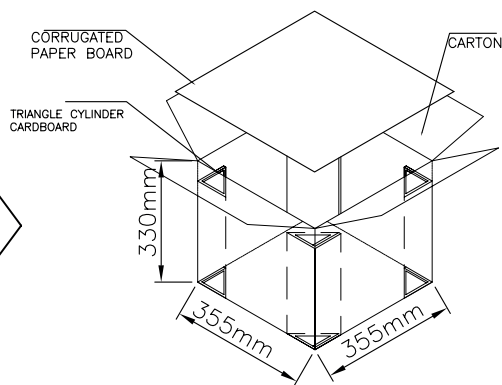
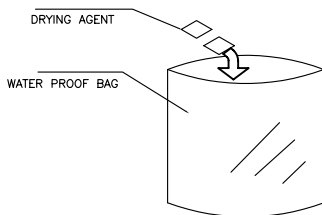
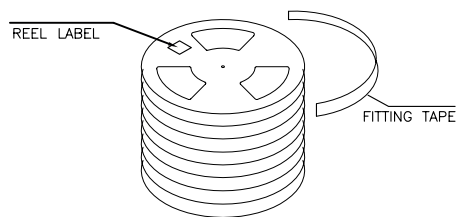
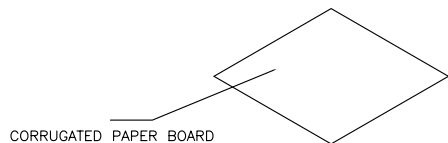

NOTES
1. MATERIALS: PS
2. PACKING: TAPE REEL(450PCS/REEL,3150PCS/CARTON)
3. SONY SS-00259 or RoHS
All Material in According With The RoHS Environment Related Substances List Controlled.

RoHS Compliant

PROJECTION:

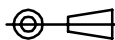

GENERAL TOLERANCE

.X = +/_ 0.2

.XX = +/_ 0.15



APPROVAL: RJ

UNIT: MM

SCALE:

SHEET: 3/3

DRAW: VICKY

DESCRIPTION: SD Card Connector - Push & Push - With Card Detection 9 pins

WERI PART NO: 693 061 010 911

SIZE

A4

REV DATE FILE BY