

N

Flexible Cable-Clamp Attachment

Straight Plug Clamp

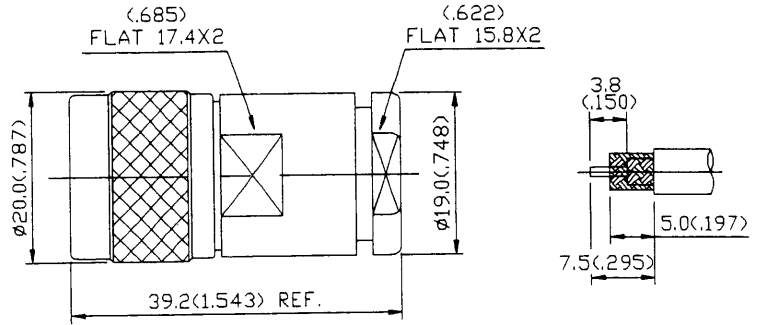

Straight Jack Clamp

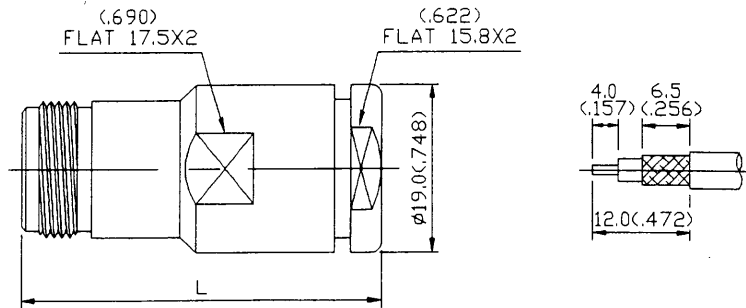
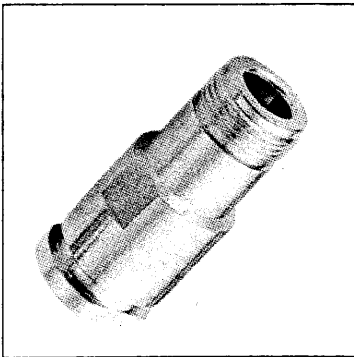

Straight Jack Bulkhead Clamp

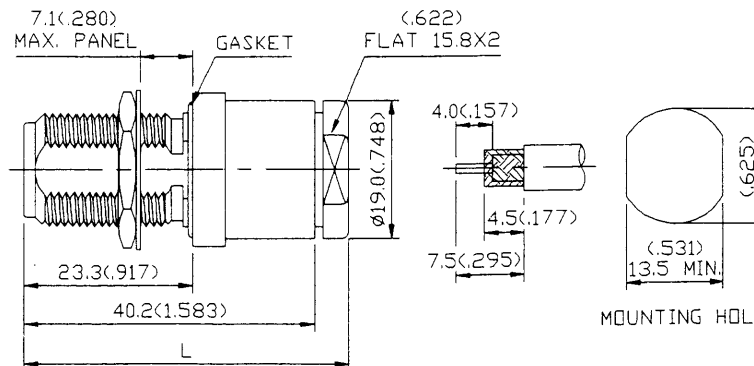
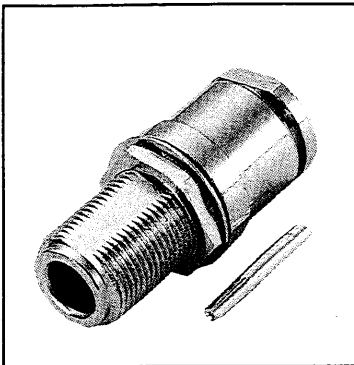

Straight Jack Bulkhead Clamp

N

Flexible Cable-Clamp Attachment

Straight Plug Clamp

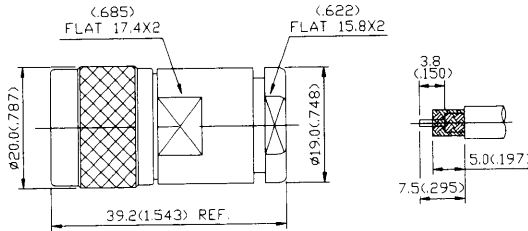
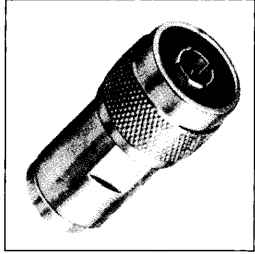

PART NO.	APPLICABLE CABLE RG/U	NOTES
11-01B-TGN	8A,213	UG NO.21B/U
11-01C-TGN	9B,214	
11-01B-7-TGN	8A,213	CAPTIVE CONTACT
11-01C-7-TGN	9B,214	
11-05F-7-TGN	58,58A,141A	UG NO.536B/U
11-05G-7-TGN	59,62A,210	UG NO.603A/U

- Finish:gold plated center contact & nickel plated body
- Insulation:Teflon
- Refer to recommended assembly instruction on page 126 (for captive contact, refer to page 127)

Straight Jack Clamp

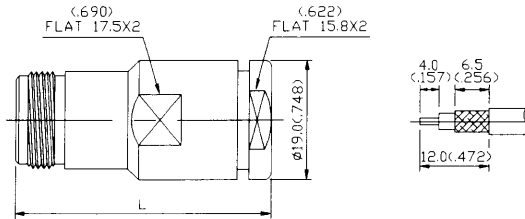
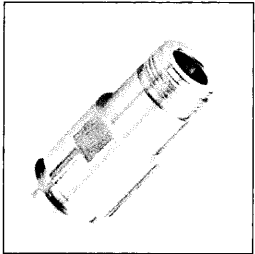

PART NO.	APPLICABLE CABLE RG/U	NOTES
11-02B-3-TGN	8A,213	L= 46.5mm
11-02C-3-TGN	9B,214	
11-02B-10-TGN	8A,213	CAPTIVE CONTACT L=41.0mm
11-02C-10-TGN	9B,214	
11-02F-7-TGN	58,58A,141A	L= 35.7mm
11-02G-7-TGN	59,62A,210	UG NO.602/U

- Finish:gold plated center contact & nickel plated body
- Insulation:Teflon
- Refer to recommended assembly instruction on page 126 (for captive contact, refer to page 127)

Straight Jack Bulkhead Clamp

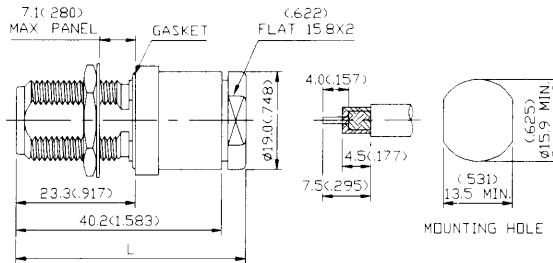
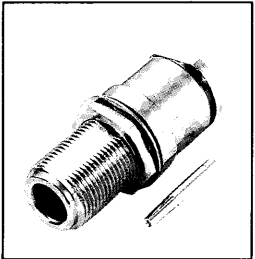

PART NO.	APPLICABLE CABLE RG/U	NOTES
11-04B-TGN	8A,213	L= 44.7
11-04C-TGN	9B,214	L= 44.7
11-04F-TGN	58,58A,141A	L= 42.8
11-04K-TGN	142 B	L= 42.8

- Finish:gold plated center contact & nickel plated body
- Insulation:Teflon
- Refer to recommended assembly instruction on page 126

Straight Jack Bulkhead Clamp

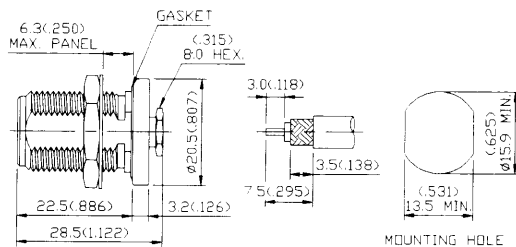
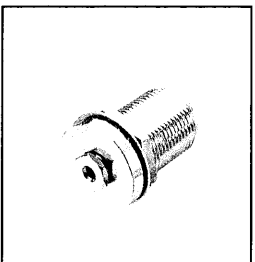

PART NO.	APPLICABLE CABLE RG/U	NOTES
11-52L-TGN	174,188A,316	

- Finish:gold plated center contact & nickel plated body
- Insulation:Teflon

Cable Mounting Instructions

CM-07 for Clamp Type Connectors (1)

Connector Body

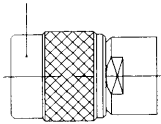

Braid Clamp



Washer

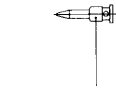

Center Contact

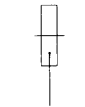

Gasket

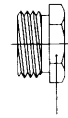

Nut

1.

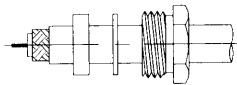

Preparation of Cable

- (1) Slide nut, washer and gasket onto cable.
- (2) Strip cable to recommended dimensions shown in catalogue.

2.

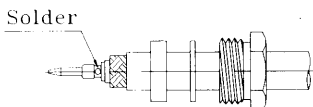

Solder Center Contact to Cable Center Conductor

- (1) Insert cable center conductor into center contact until it butts against cable dielectric.
- (2) Solder center contact.

3.

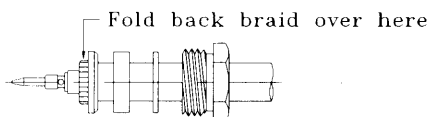

Install Braid Clamp

- (1) Place braid clamp over cable braid.
- (2) Comb braid wires out straight and fold back over front shoulder of braid clamp.
- (3) Trim braid wires flush with edge of braid clamp.

4.

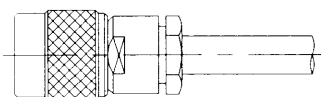

Final Assembly

- (1) Mount cable assembly and hardware into connector body.
- (2) Screw and tighten nut.

Cable Mounting Instructions

CM-08 for Clamp Type Connectors (2)

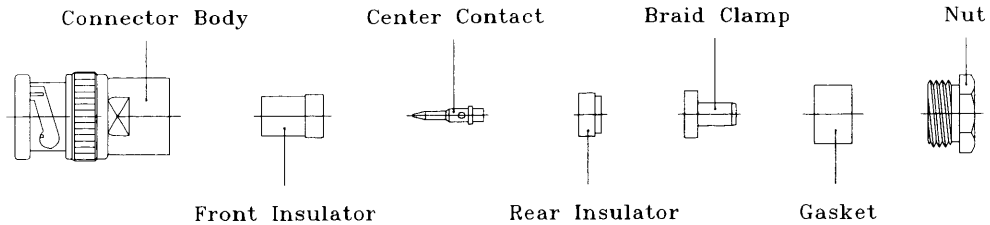

1.

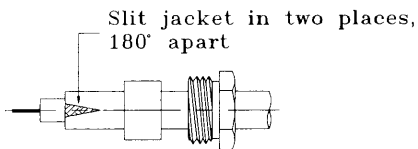

Preparation of Cable

- (1) Slide nut and gasket onto cable.
- (2) Strip cable to recommended dimensions shown in catalogue.
- (3) Slit cable jacket in two places, 180° apart.

2.

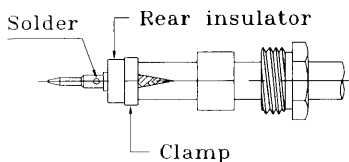

Solder Center Contact to Cable Center Conductor

- (1) Place braid clamp between cable dielectric and braid.
- (2) Slide on rear insulator and center contact (these parts must butt).
- (3) Solder center contact to cable center conductor.

3.

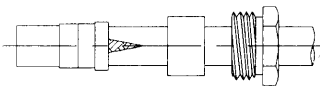

Install Insulator

- (1) Install front insulator over center contact.

4.

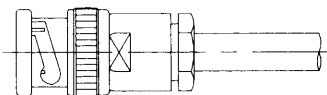

Final Assembly

- (1) Mount cable assembly and hardware into connector body.
- (2) Screw and tighten nut.