



Main

Range of product	Zelio Time
Product or component type	Modular timing relay
Discrete output type	Relay
Component name	RE11R
Time delay type	A Ac At B Bw C D Di H Ht
Time delay range	0.1...1 s 1...10 h 1...10 min 1...10 s 10...100 h 6...60 min 6...60 s
[Us] rated supply voltage	24 V DC 24...240 V AC 50/60 Hz
Nominal output current	8 A

Complementary

Contacts material	AgNi (cadmium free)
Width pitch dimension	17.5 mm
Control type	Selector switch on front panel
Voltage range	0.85...1.1 Us
Connections - terminals	Screw terminals, clamping capacity: 2 x 1.5 mm ² without cable end Screw terminals, clamping capacity: 2 x 2.5 mm ² + 1 x 4 mm ² with cable end
Housing material	Self-extinguishing
Repeat accuracy	+/- 0.5 % conforming to IEC 61812-1
Temperature drift	+/- 0.05 %/°C
Voltage drift	+/- 0.2 %/V
Setting accuracy of time delay	+/- 10 % of full scale at 25 °C conforming to IEC 61812-1
Minimum pulse duration	100 ms with load in parallel 30 ms
Maximum reset time	100 ms on de-energisation
On-load factor	100 %
Maximum power consumption	32 VA 240 V
Maximum power consumption	0.6 W 24 V 1.5 W 240 V
Minimum switching current	10 mA
Maximum switching current	8 A
Maximum switching voltage	250 V
Breaking capacity	2000 VA
Breaking capacity	80 W
Electrical durability	100000 cycles 8 A at 250 V resistive
Mechanical durability	5000000 cycles
[Uimp] rated impulse withstand voltage	5 kV for 1.2...50 µs conforming to IEC 60664-1 5 kV for 1.2...50 µs conforming to IEC 61812-1

The information provided in this documentation contains general descriptions and/or technical characteristics of the performance of the products contained herein. This documentation is not intended as a substitute for and is not to be used for determining suitability or reliability of these products for specific user applications. It is the duty of any such user or integrator to perform the appropriate and complete risk analysis, evaluation and testing of the products with respect to the relevant specific application or use thereof. Neither Schneider Electric Industries SAS nor any of its affiliates or subsidiaries shall be responsible or liable for misuse of the information contained herein.

Marking	CE
Creepage distance	4 kV/3 conforming to IEC 60664-1
Surge withstand	1 kV (differential mode) conforming to IEC 61000-4-5 level 3 2 kV (common mode) conforming to IEC 61000-4-5 level 3
Mounting support	35 mm symmetrical mounting rail conforming to EN 50022
Local signalling	LED indicator green flashing: timing in progress LED indicator green on steady: relay energised, no timing in progress LED indicator green pulsing: relay energised, no timing in progress (except functions Di-D)
Product weight	0.06 kg

Environment

Immunity to microbreaks	> 10 ms
Dielectric strength	2.5 kV 1 mA/1 minute 50 Hz conforming to IEC 61812-1
Standards	73/23/EEC 89/336/EEC 93/68/EEC EN 50081-1/2 EN 50082-1/2 IEC 60669-2-3 IEC 61812-1
Product certifications	CSA CULus GL
Ambient air temperature for storage	-30...60 °C
Ambient air temperature for operation	-20...60 °C
IP degree of protection	IP20 (terminal block) conforming to IEC 60529 IP40 (housing) conforming to IEC 60529 IP50 (front panel) conforming to IEC 60529
Vibration resistance	0.35 mm (f = 10...55 Hz) conforming to IEC 60068-2-6
Relative humidity	93 % without condensation conforming to IEC 60068-2-3
Resistance to electrostatic discharge	6 kV (in contact) conforming to IEC 61000-4-2 level 3 8 kV (in air) conforming to IEC 61000-4-2 level 3
Resistance to electromagnetic fields	10 V/m, 80 MHz to 1 GHz conforming to ENV 50140/204 level 3 10 V/m, 80 MHz to 1 GHz conforming to IEC 61000-4-3 level 3
Resistance to fast transients	1 kV, capacitive connecting clip conforming to IEC 61000-4-4 level 3 2 kV, direct conforming to IEC 61000-4-4 level 3
Immunity to radioelectric fields	10 V (0.15...80 MHz) conforming to ENV 50141 (IEC 61000-4-6)
Immunity to voltage dips	30 %/10 ms conforming to IEC 61000-4-11 60 %/100 ms conforming to IEC 61000-4-11 95 %/5 s conforming to IEC 61000-4-11
Disturbance radiated/conducted	Class B conforming to EN 55022 (EN 55011 group 1)
RoHS EUR status	Compliant
RoHS EUR conformity date	0627

Function A: Delay on Energisation

Description

The timing period T begins on energisation. After timing, the output(s) R close(s). The second output can be either timed or instantaneous.

Function: 1 Output



Function: 2 Outputs



2 timed outputs (R1/R2) or 1 timed output (R1) and 1 instantaneous output (R2 inst.)

Function Ac: Timing After Closing and Opening of Control Contact

Description

After power-up, closing of the control contact C causes the timing period T to start (timing can be interrupted by operating the Gate control contact G). At the end of this timing period, the relay closes.

When control contact C re-opens, the timing T starts.

At the end of this timing period T, the output reverts to its initial position (timing can be interrupted by operating the Gate control contact G).

The second output can be either timed or instantaneous.

Function: 1 Output

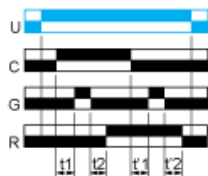

Function: 2 Outputs

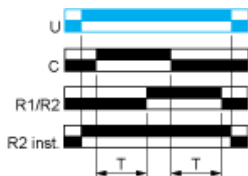

2 timed outputs (R1/R2) or 1 timed output (R1) and 1 instantaneous output (R2 inst.)

Function At: Delay on Energisation with Memory

Description

After power-up, the first opening of control contact C starts the timing. Timing can be interrupted each time control contact closes. When the cumulative total of time periods elapsed reaches the pre-set value T, the output relay closes.

Function: 1 Output

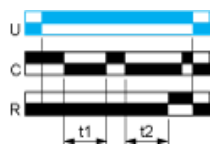

$$T = t1 + t2 + \dots$$

Function B: Timing on Impulse, One Shot

Description

After power-up, pulsing or maintaining control contact C starts the timing T. The output R closes for the duration of the timing period T then reverts to its initial state.

Function: 1 Output



Function Bw: Pulse Output (Width Adjustable)

Description

On closing and opening of control contact C, the output R closes for the duration of the timing period T.

Function: 1 Output



Function C: Timing After Opening of Control Contact

Description

After power-up and closing of the control contact C, the output R closes. When control contact C re-opens, timing T starts. At the end of the timing period, the output(s) R revert(s) to its/their initial state. The second output can be either timed or instantaneous.

Function: 1 Output

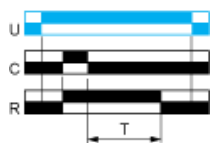

Function: 2 Outputs

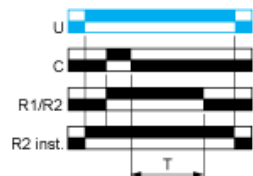

2 timed outputs (R1/R2) or 1 timed output (R1) and 1 instantaneous output (R2 inst.)

Function D: Symmetrical Flashing, Start with Output in Rest Position

Description

Repetitive cycle with two timing periods T of equal duration, with output(s) R changing state at the end of each timing period T. The second output can be either timed or instantaneous.

Function: 1 Output



Function: 2 Outputs

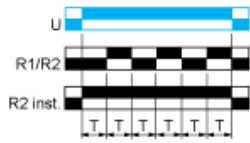

2 timed outputs (R1/R2) or 1 timed output (R1) and 1 instantaneous output (R2 inst.)

Function Di: Symmetrical Flashing, Start with Output in Operating Position

Description

Repetitive cycle with two timing periods T of equal duration, with output(s) R changing state at the end of each timing period T . The second output can be either timed or instantaneous.

Function: 1 Output

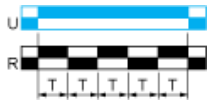

Function: 2 Outputs

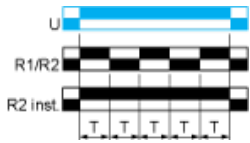

2 timed outputs (R1/R2) or 1 timed output (R1) and 1 instantaneous output (R2 inst.)

Function H: Timing on Energisation

Description

On energisation of the relay, timing period T starts and the output(s) R close(s). At the end of the timing period T , the output(s) R revert(s) to its/their initial state. The second output can be either timed or instantaneous.

Function: 1 Output



Function: 2 Outputs

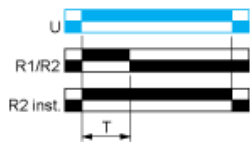

2 timed outputs (R1/R2) or 1 timed output (R1) and 1 instantaneous output (R2 inst.)

Function Ht: Timing on Energisation with Memory

Description

On energisation, the output R closes for the duration of a timing period T then reverts to its initial state.

Pulsing or maintaining control contact C will again close the output R .

Timing T is only active when control contact C is released and so the output R will not revert to its initial state until after a time $t_1 + t_2 + \dots$

The relay memorises the total, cumulative opening time of control contact C and, once the set time T is reached, the output R reverts to its initial state.

Function: 1 Output



$$T = t_1 + t_2 + \dots$$

Legend

 Relay de-energised

 Relay energised

 Output open

 Output closed

C Control contact

G Gate

R Relay or solid state output

R1/ 2 timed outputs

R2

R2 The second output is instantaneous if the right position is selected inst.

T Timing period

Ta Adjustable On-delay

Tr Adjustable Off-delay

U Supply

Width 17.5 mm

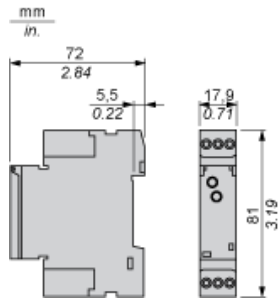

Internal Wiring Diagram

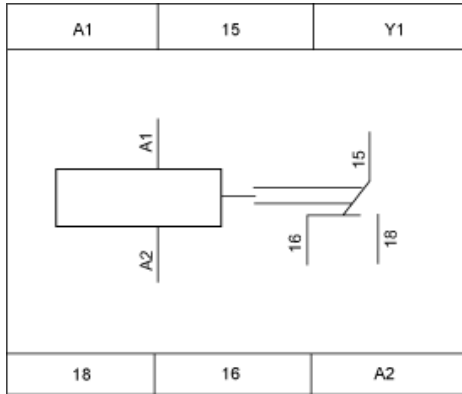

Wiring Diagram

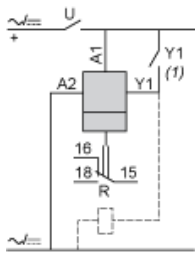

1) Contact Y1:

- Control for functions B, C, Ac, Bw, Ad, Ah, N, O, W, T, Tt.
- Partial stop for functions At, Ht and Pt.
- Function D if Di selected.
- Not used for functions A, H and P.