

Features

- Compact design to save board space - 1206 footprint
- Small size results in very fast time to react to fault events
- Symmetrical design
- Low profile
- RoHS compliant* and halogen free**
- Agency recognition:   

Applications

- USB port protection - USB 2.0, 3.0 & OTG
- HDMI 1.4 Source protection
- PC motherboards - Plug and Play protection
- Mobile phones - Battery and port protection
- PDAs / digital cameras
- Game console port protection

MF-NSMF Series - PTC Resettable Fuses

Electrical Characteristics

Model	V max. Volts	I max. Amps	I _{hold}	I _{trip}	Resistance		Max. Time To Trip		Tripped Power Dissipation
			Amperes at 23 °C		Ohms at 23 °C		Amperes at 23 °C	Seconds at 23 °C	Watts at 23 °C
			Hold	Trip	R _{Min.}	R _{1Max.}			Typ.
MF-NSMF012	30.0	10	0.12	0.29	1.35	8.50	1.0	0.20	0.4
MF-NSMF020	24.0	10	0.20	0.46	0.60	2.60	1.0	0.60	0.6
MF-NSMF020X***	30.0	60	0.20	0.40	0.60	3.30	1.0	0.60	0.6
MF-NSMF035	6.0	100	0.35	0.75	0.30	1.20	8.0	0.10	0.6
MF-NSMF035X****	16.0	20	0.35	0.75	0.30	1.40	3.5	0.14	0.6
MF-NSMF050	13.2	100	0.50	1.00	0.15	0.70	8.0	0.10	0.4
MF-NSMF075	6.0	100	0.75	1.50	0.10	0.40	8.0	0.10	0.4
MF-NSMF110	6.0	100	1.10	2.20	0.06	0.20	8.0	0.10	0.6
MF-NSMF150	6.0	100	1.50	3.00	0.03	0.13	8.0	0.30	0.6
MF-NSMF150D	6.0	100	1.50	3.00	0.03	0.11	8.0	0.30	1.0
MF-NSMF200	6.0	100	2.00	4.00	0.02	0.085	8.0	1.00	0.7

***Features Multifuse® freeXpansion Design™ for MF-NSMF Series (CSA/TÜV pending)

****Features Multifuse® freeXpansion Design™ for MF-NSMF Series (CSA pending)

Environmental Characteristics

Operating Temperature.....	-40 °C to +85 °C
Maximum Device Surface Temperature in Tripped State	125 °C
Passive Aging	+85 °C, 1000 hours..... ±5 % typical resistance change
Humidity Aging	+85 °C, 85 % R.H. 1000 hours..... ±5 % typical resistance change
Thermal Shock	+85 °C to -40 °C, 20 times..... ±10 % typical resistance change
Solvent Resistance.....	MIL-STD-202, Method 215..... No change
Vibration	MIL-STD-883C, Method 2007.1, No change Condition A

Test Procedures And Requirements For Model MF-NSMF Series

Test	Test Conditions	Accept/Reject Criteria
Visual/Mech.....	Verify dimensions and materials.....	Per MF physical description
Resistance.....	In still air @ 23 °C.....	R _{min} ≤ R ≤ R _{1max}
Time to Trip.....	At specified current, V _{max} , 23 °C.....	T ≤ max. time to trip (seconds)
Hold Current.....	30 min. at I _{hold}	No trip
Trip Cycle Life.....	V _{max} , I _{max} , 100 cycles.....	No arcing or burning
Trip Endurance	V _{max} , 48 hours.....	No arcing or burning
Solderability.....	ANSI/J-STD-002.....	95 % min. coverage
UL File Number	E174545 http://www.ul.com/ Follow link to Certifications, then UL File No., enter E174545	
CSA File Number.....	CA110338 http://directories.csa-international.org/ Under "Certification Record" and "File Number" enter 110338-0-000	
TÜV Certificate Number	R 02057213 http://www.tuvdotcom.com/ Follow link to "other certificates", enter File No. 2057213	

*RoHS Directive 2002/95/EC Jan 27, 2003 including Annex.

**To be considered halogen free, each homogenous material can have a maximum concentration of 900 ppm of either bromine or chlorine.

Specifications are subject to change without notice.

Customers should verify actual device performance in their specific applications.

Additional Applications

- Automotive electronic control modules

MF-NSMF Series - PTC Resettable Fuses

BOURNS®

Thermal Derating Chart - I_{hold} (Amps)

Model	Ambient Operating Temperature								
	-40 °C	-20 °C	0 °C	23 °C	40 °C	50 °C	60 °C	70 °C	85 °C
MF-NSMF012	0.19	0.17	0.15	0.12	0.11	0.10	0.09	0.08	0.07
MF-NSMF020	0.30	0.27	0.24	0.20	0.18	0.16	0.14	0.12	0.11
MF-NSMF020X	0.30	0.27	0.24	0.20	0.18	0.16	0.14	0.12	0.10
MF-NSMF035	0.51	0.46	0.40	0.35	0.30	0.27	0.24	0.22	0.18
MF-NSMF035X	0.58	0.51	0.44	0.35	0.31	0.28	0.24	0.21	0.16
MF-NSMF050	0.76	0.68	0.59	0.50	0.44	0.40	0.35	0.32	0.26
MF-NSMF075	1.11	1.00	0.85	0.75	0.67	0.61	0.52	0.50	0.42
MF-NSMF110	1.64	1.46	1.30	1.10	0.92	0.83	0.80	0.65	0.52
MF-NSMF150	2.20	1.99	1.77	1.50	1.34	1.23	1.10	1.01	0.84
MF-NSMF150D	2.20	1.99	1.77	1.50	1.34	1.23	1.10	1.01	0.84
MF-NSMF200	2.88	2.61	2.28	2.00	1.80	1.66	1.51	1.39	1.19

Typical Time to Trip at 23 °C

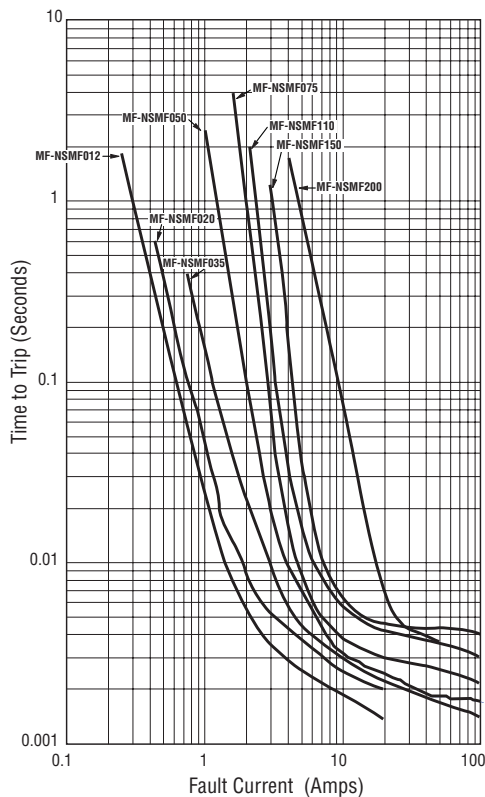

The Time to Trip curves represent typical performance of a device in a simulated application environment. Actual performance in specific customer applications may differ from these values due to the influence of other variables.

How to Order

MF - NSMF 020 X - 2

Multifuse® Product Designator

Series
NSMF = 1206 Surface Mount Component

Hold Current, I_{hold}
012-200 (0.12 Amps - 2.00 Amps)

Options
= Standard
D =
X = Multifuse® freeExpansion Design™ MF-NSMF Series

Packaging
Packaged per EIA 481-1
-2 = Tape and Reel

Typical Part Marking

Represents total content. Layout may vary.

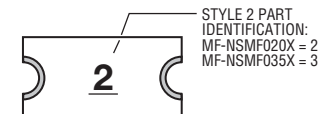
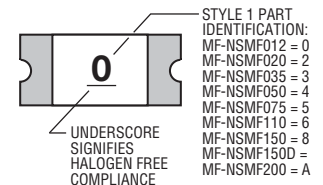

BIWEEKLY DATE CODE WILL APPEAR ON THE PACKAGING LABEL:
WEEK 1 AND 2 = A
WEEK 51 AND 52 = Z

MF-NSMF Series - PTC Resettable Fuses

BOURNS®

Product Dimensions

Model	A		B		C		D	Style
	Min.	Max.	Min.	Max.	Min.	Max.	Min.	
MF-NSMF012	$\frac{3.00}{(0.118)}$	$\frac{3.40}{(0.134)}$	$\frac{1.40}{(0.055)}$	$\frac{1.80}{(0.071)}$	$\frac{0.70}{(0.028)}$	$\frac{1.10}{(0.043)}$	$\frac{0.25}{(0.010)}$	1
MF-NSMF020	$\frac{3.00}{(0.118)}$	$\frac{3.40}{(0.134)}$	$\frac{1.40}{(0.055)}$	$\frac{1.80}{(0.071)}$	$\frac{0.48}{(0.019)}$	$\frac{0.85}{(0.033)}$	$\frac{0.25}{(0.010)}$	1
MF-NSMF020X	$\frac{3.00}{(0.118)}$	$\frac{3.40}{(0.134)}$	$\frac{1.40}{(0.055)}$	$\frac{1.80}{(0.071)}$	$\frac{0.40}{(0.016)}$	$\frac{0.85}{(0.033)}$	$\frac{0.25}{(0.010)}$	2
MF-NSMF035	$\frac{3.00}{(0.118)}$	$\frac{3.40}{(0.134)}$	$\frac{1.40}{(0.055)}$	$\frac{1.80}{(0.071)}$	$\frac{0.48}{(0.019)}$	$\frac{0.85}{(0.033)}$	$\frac{0.25}{(0.010)}$	1
MF-NSMF035X	$\frac{3.00}{(0.118)}$	$\frac{3.40}{(0.134)}$	$\frac{1.40}{(0.055)}$	$\frac{1.80}{(0.071)}$	$\frac{0.40}{(0.016)}$	$\frac{0.85}{(0.033)}$	$\frac{0.25}{(0.010)}$	2
MF-NSMF050	$\frac{3.00}{(0.118)}$	$\frac{3.40}{(0.134)}$	$\frac{1.40}{(0.055)}$	$\frac{1.80}{(0.071)}$	$\frac{0.48}{(0.019)}$	$\frac{0.85}{(0.033)}$	$\frac{0.25}{(0.010)}$	1
MF-NSMF075	$\frac{3.00}{(0.118)}$	$\frac{3.40}{(0.134)}$	$\frac{1.40}{(0.055)}$	$\frac{1.80}{(0.071)}$	$\frac{0.40}{(0.016)}$	$\frac{0.70}{(0.028)}$	$\frac{0.25}{(0.010)}$	1
MF-NSMF110	$\frac{3.00}{(0.118)}$	$\frac{3.40}{(0.134)}$	$\frac{1.40}{(0.055)}$	$\frac{1.80}{(0.071)}$	$\frac{0.40}{(0.016)}$	$\frac{0.70}{(0.028)}$	$\frac{0.25}{(0.010)}$	1
MF-NSMF150	$\frac{3.00}{(0.118)}$	$\frac{3.40}{(0.134)}$	$\frac{1.40}{(0.055)}$	$\frac{1.80}{(0.071)}$	$\frac{0.40}{(0.016)}$	$\frac{0.70}{(0.028)}$	$\frac{0.25}{(0.010)}$	1
MF-NSMF150D	$\frac{3.00}{(0.118)}$	$\frac{3.40}{(0.134)}$	$\frac{1.40}{(0.055)}$	$\frac{1.80}{(0.071)}$	$\frac{0.40}{(0.016)}$	$\frac{0.75}{(0.030)}$	$\frac{0.25}{(0.010)}$	1
MF-NSMF200	$\frac{3.00}{(0.118)}$	$\frac{3.50}{(0.138)}$	$\frac{1.40}{(0.055)}$	$\frac{1.80}{(0.071)}$	$\frac{0.70}{(0.028)}$	$\frac{1.60}{(0.063)}$	$\frac{0.25}{(0.010)}$	1

Packaging: 3000 pcs. per reel.

DIMENSIONS: $\frac{\text{MM}}{\text{(INCHES)}}$

Style 1 Top and Bottom View

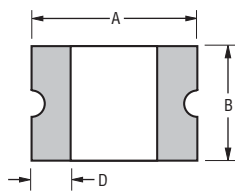

Style 1 Side View

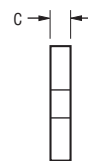

Style 1 Recommended Pad Layout

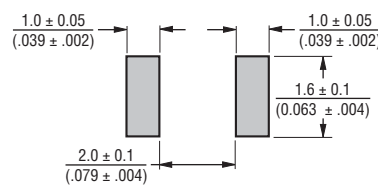

Terminal material:

Electroless Ni under immersion Au

Termination pad solderability:

Standard Au finish:
Meets ANSI/J-STD-002 Category 2.

Recommended Storage:

40 °C max./70 % RH max.

Style 2 Top View

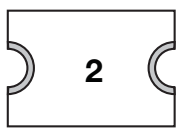

Style 2 Bottom View

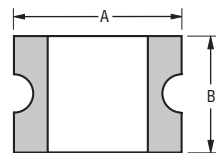

Style 2 Side View

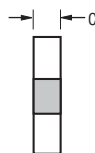

Style 2 Recommended Pad Layout

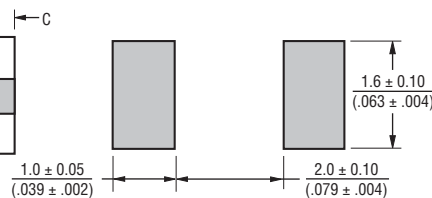

Solder Reflow Recommendations

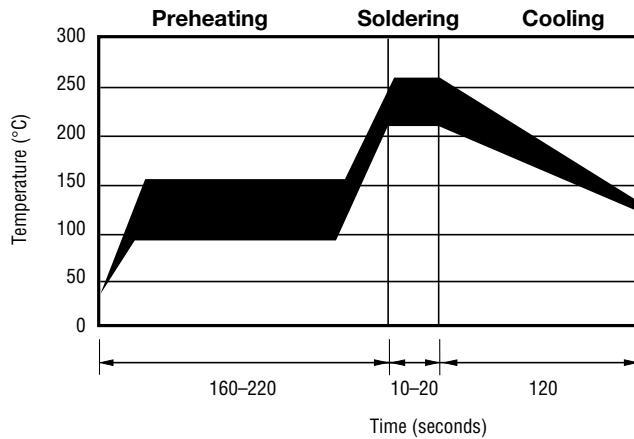

Notes:

- MF-NSMF models cannot be wave soldered. Please contact Bourns for hand soldering recommendations.
- If reflow temperatures exceed the recommended profile, devices may not meet the performance requirements.
- Compatible with Pb and Pb-free solder reflow profiles.
- Excess solder may cause a short circuit, especially during hand soldering. Please refer to the Multifuse® Polymer PTC Soldering Recommendation guidelines.

MF-NSMF Series Tape and Reel Specifications

BOURNS®

Tape Dimensions	MF-NSMF012 & MF-NSMF200 per EIA 481-1	MF-NSMF020 ~ MF-NSMF050 & MF-NSMF150D per EIA 481-1	MF-NSMF075 ~ MF-NSMF150 per EIA 481-1	MF-NSMF020X & MF-NSMF035X per EIA 481-1
W	8.0 ± 0.30 (0.315 ± 0.012)	8.0 ± 0.30 (0.315 ± 0.012)	8.0 ± 0.30 (0.315 ± 0.012)	8.0 ± 0.30 (0.315 ± 0.012)
P ₀	4.0 ± 0.10 (0.157 ± 0.004)	4.0 ± 0.10 (0.157 ± 0.004)	4.0 ± 0.10 (0.157 ± 0.004)	4.0 ± 0.10 (0.157 ± 0.004)
P ₁	4.0 ± 0.10 (0.157 ± 0.004)	4.0 ± 0.10 (0.157 ± 0.004)	4.0 ± 0.10 (0.157 ± 0.004)	4.0 ± 0.10 (0.157 ± 0.004)
P ₂	2.0 ± 0.05 (0.079 ± 0.002)	2.0 ± 0.05 (0.079 ± 0.002)	2.0 ± 0.05 (0.079 ± 0.002)	2.0 ± 0.05 (0.079 ± 0.002)
A ₀	1.90 ± 0.10 (0.075 ± 0.004)	1.90 ± 0.10 (0.075 ± 0.004)	1.90 ± 0.10 (0.075 ± 0.004)	1.90 ± 0.10 (0.075 ± 0.004)
B ₀	3.50 ± 0.10 (0.138 ± 0.004)	3.45 ± 0.10 (0.136 ± 0.004)	3.45 ± 0.10 (0.136 ± 0.004)	3.55 ± 0.10 (0.140 ± 0.004)
B ₁ max.	4.35 (0.171)	4.35 (0.171)	4.35 (0.171)	4.35 (0.171)
D ₀	$1.5 + 0.10/-0.0$ (0.059 + 0.004/-0)	$1.5 + 0.10/-0.0$ (0.059 + 0.004/-0)	$1.5 + 0.10/-0.0$ (0.059 + 0.004/-0)	$1.5 + 0.10/-0.0$ (0.059 + 0.004/-0)
F	3.5 ± 0.05 (0.138 ± 0.002)	3.5 ± 0.05 (0.138 ± 0.002)	3.5 ± 0.05 (0.138 ± 0.002)	3.5 ± 0.05 (0.138 ± 0.002)
E ₁	1.75 ± 0.10 (0.069 ± 0.004)	1.75 ± 0.10 (0.069 ± 0.004)	1.75 ± 0.10 (0.069 ± 0.004)	1.75 ± 0.10 (0.069 ± 0.004)
E ₂ min.	6.25 (0.246)	6.25 (0.246)	6.25 (0.246)	6.25 (0.246)
T max.	0.6 (0.024)	0.6 (0.024)	0.6 (0.024)	0.6 (0.024)
T ₁ max.	0.1 (0.004)	0.1 (0.004)	0.1 (0.004)	0.1 (0.004)
K ₀	1.35 ± 0.10 (0.053 ± 0.004)	1.04 ± 0.10 (0.041 ± 0.004)	0.85 ± 0.10 (0.033 ± 0.004)	0.80 ± 0.10 (0.032 ± 0.004)
Leader min.	390 (15.35)	390 (15.35)	390 (15.35)	390 (15.35)
Trailer min.	160 (6.30)	160 (6.30)	160 (6.30)	160 (6.30)
Reel Dimensions				
A max.	185 (7.28)	185 (7.28)	185 (7.28)	185 (7.28)
N min.	50 (1.97)	50 (1.97)	50 (1.97)	50 (1.97)
W ₁	$8.4 + 1.5/-0.0$ (0.331 + 0.059/-0.0)	$8.4 + 1.5/-0.0$ (0.331 + 0.059/-0.0)	$8.4 + 1.5/-0.0$ (0.331 + 0.059/-0.0)	$8.4 + 1.5/-0.0$ (0.331 + 0.059/-0.0)
W ₂ max.	14.4 (0.567)	14.4 (0.567)	14.4 (0.567)	14.4 (0.567)

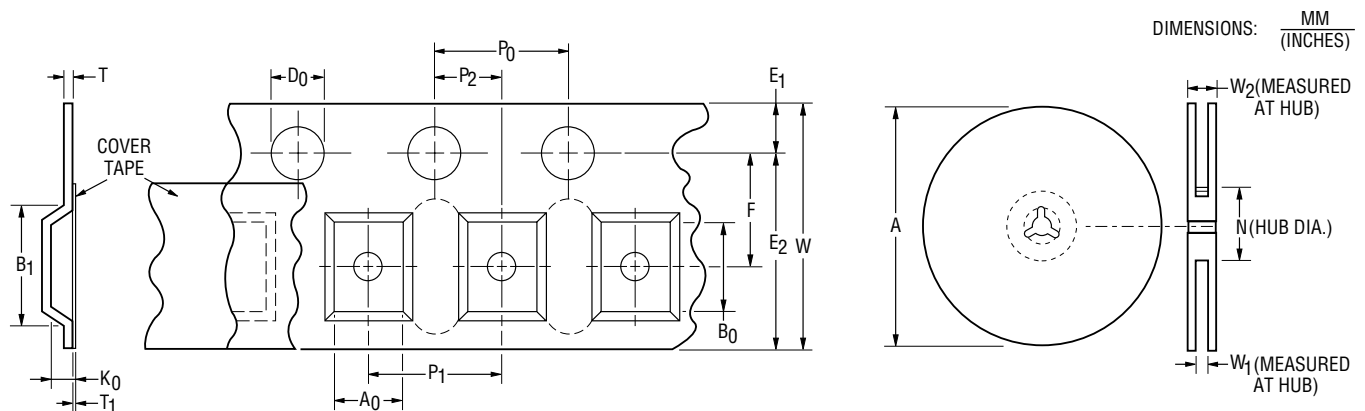

Specifications are subject to change without notice.
Customers should verify actual device performance in their specific applications.