



Our *passion* is enclosures.

The evolution in enclosure technology.

ROLEC aluPLUS.

The PLUS in technology and design.

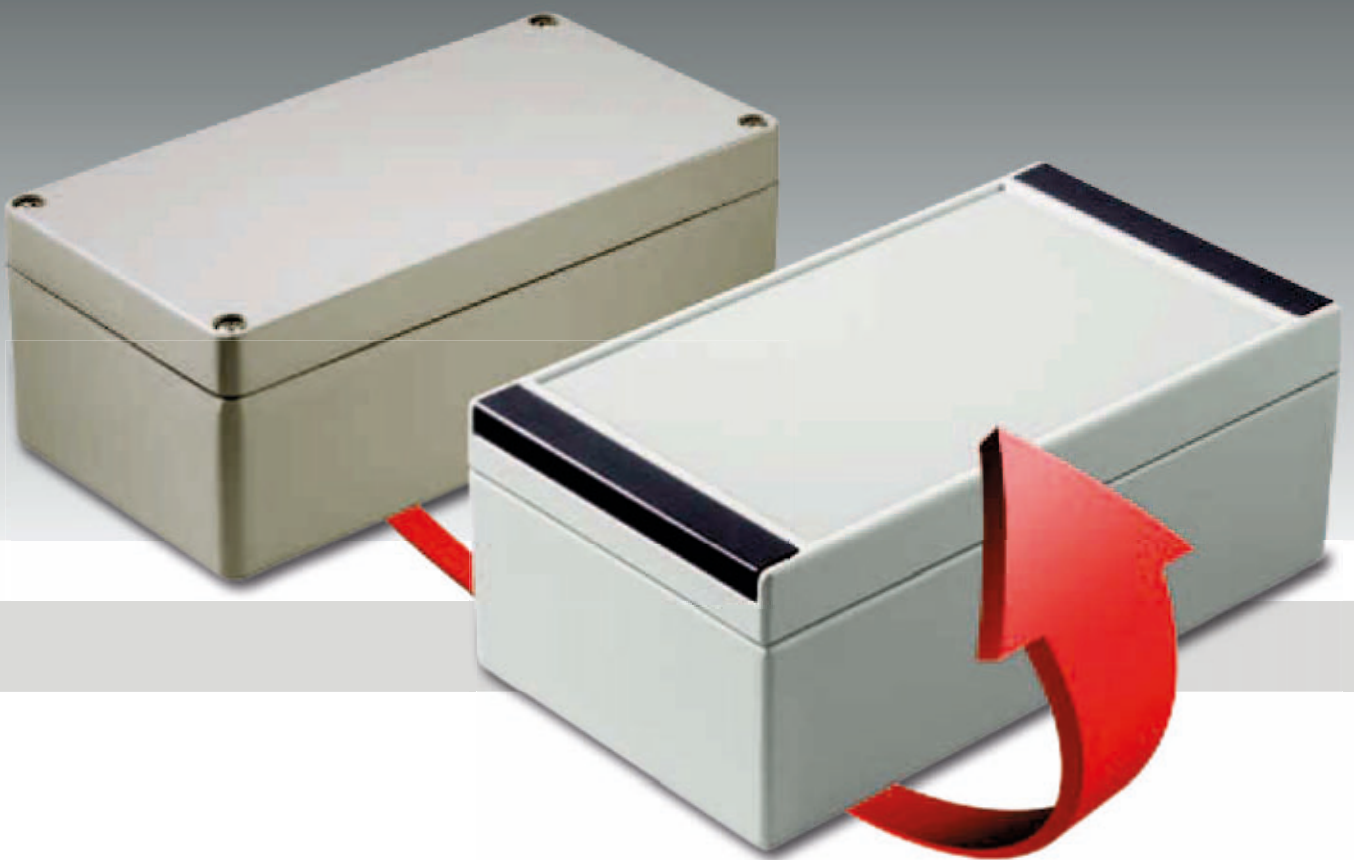



ROLEC milestones
in enclosure development.



Our *passion* is enclosures.

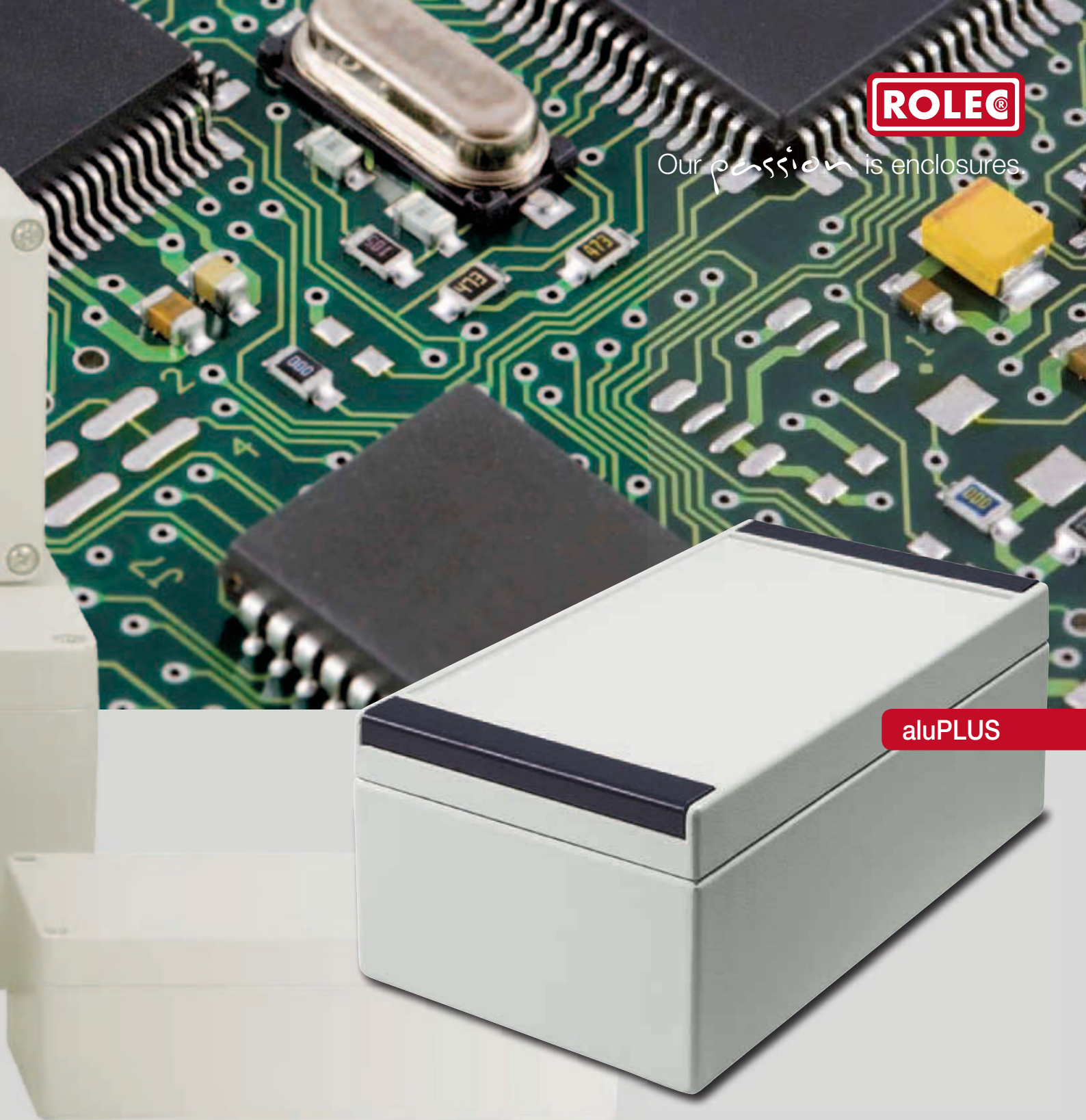

aluPLUS

The evolution: From terminal to electronic enclosure.

Over 40 years ago Friedhelm Rose embarked on the development of enclosure technology. His inventions became standards. ROLEC is still setting them today.

Originally designed as terminal enclosures, today ROLEC enclosures primarily protect electrical and electronic components in harsh environments. They are constantly being aligned with current demands – investment in modification, in line with modern CNC-controlled processing machines. ROLEC drives progress.

ROLEC is constantly setting new benchmarks in the technology and design of robust industrial enclosures. The new benchmark is the aluPLUS enclosure range! ROLEC accompanies industrial development.

ROLEC produces the trailblazers. The latest self-imposed task: Transfer new technology to conventional enclosure dimensions. Result: aluPLUS. The attachment and installation dimensions precisely reflect those of the familiar standard enclosures, e.g. aluKOM.

ROLEC aluPLUS. Transfer brilliant ROLEC ideas to standard enclosures.



Advantages at a glance



Integrated recesses for membrane keypads.



Enclosure attachment with closed lids.



Design covers for the perfect look.



Economical lid supports.



Attachment domes in the enclosures and lids for components.



Standardised installation dimensions.

ROLEC has no role models. Is the standard. ROLEC has its ear to the market. The analysis of thousands of orders shows what users want. Why then constantly repeat working processes, when the same things have been considered for so many requirements?! For example: The recess in the lid surface for protecting the edges of the membrane keypad.

Another example: The application of external feet for external fastening is only an auxiliary addition and not essential to the design. aluPLUS enclosures can be fastened with closed lids.

And another: Just four screws and even contact pressure guarantee leak-tightness. Why do they need to detract from the appearance?

With aluPLUS the attachment level disappears beneath a retrospectively easy clip-on plastic design cover. The appealing result: An elegant design previously unknown in standard industrial enclosures.

Lid supports: Compatibility with standard enclosures was the main target with aluPLUS enclosures. As such lid supports such as those with aluCASE could not be integrated. ROLEC therefore developed economical lid supports as accessories.

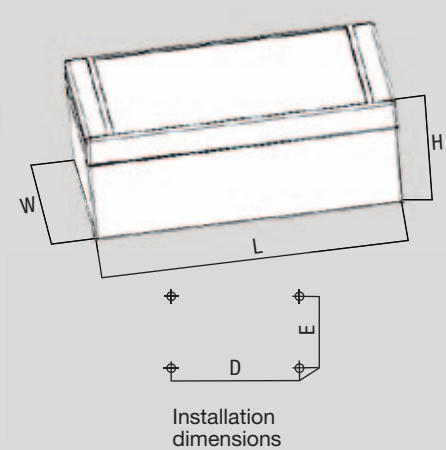

The current delivery program



aluPLUS range overview

Type	Mat.-No	L	W	H	D	E	g	M	D	EMV	L	T	DH	Plus
AP 120	196.120.000	122	120	82	106	82	770	●	□	●	●	●	●	●
AP 122	196.122.000	220	120	82	204	82	1110	●	□	●	●	●	●	●
AP 161	196.161.000	160	160	90	140	110	1190	●	□	●	●	●	●	●
AP 162	196.162.000	260	160	90	240	110	1620	●	□	●	●	●	●	●

□ Standard ● Available ○ Not available

Technical information

Enclosure
Die-cast aluminium
EN AN-44300 DIN EN 1706
(GD AL SI 12 / DIN 1725)
1° mould slope for casting
ejection, internal measures
diminishing circulatory towards
enclosure bottom by 1°.

Lid screws
Stainless steel 1.4567, captive.

Integrated recess
1.7 mm recess in the lid for
membrane keypad or front
plates, membrane dimension-
al data for standard powder
coating.

Optional lid support
Screw hinge, cover screw with
plastic element from stainless
steel 1.4567 and polyamide
(PA6).







Clip-on design cover
Plastic polyoxymethylene
(POM) in RAL 7016, anthracite
grey.

Internal mounting
Attachment webs in the bottom
section and attachment domes
in the top section ensure
secure fastening of installed
components.

Ingress protection
IP 66 / EN 60529
IP 67 / EN 60529 (optional)

Gasket
Silicone gasket
(-50°C bis +140°C)
Optional: Chloroprene gasket
(-30°C bis +90°C)

Coating
Powder coated in RAL 7035,
light grey,
optional: Special colours

-  **M** Mounting plates
-  **D** Silicone gasket
-  **EMV** Shielding
-  **L** Corrosion proof coating
-  **T** Supporting rails for terminal blocks
-  **DH** Lid support
-  **PLUS** Protection class IP 67

ROLEC Attachment and installation dimensions

aluPLUS

AP 120

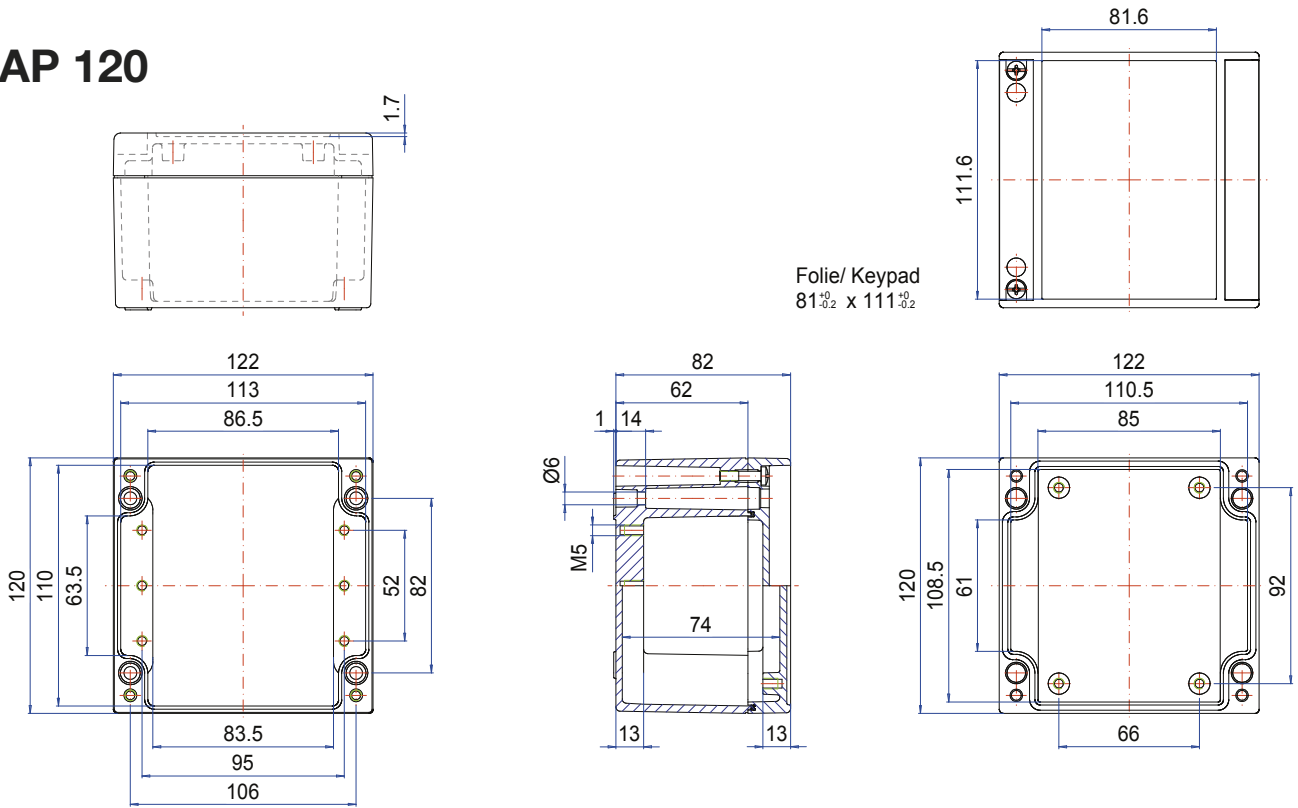

AP 122

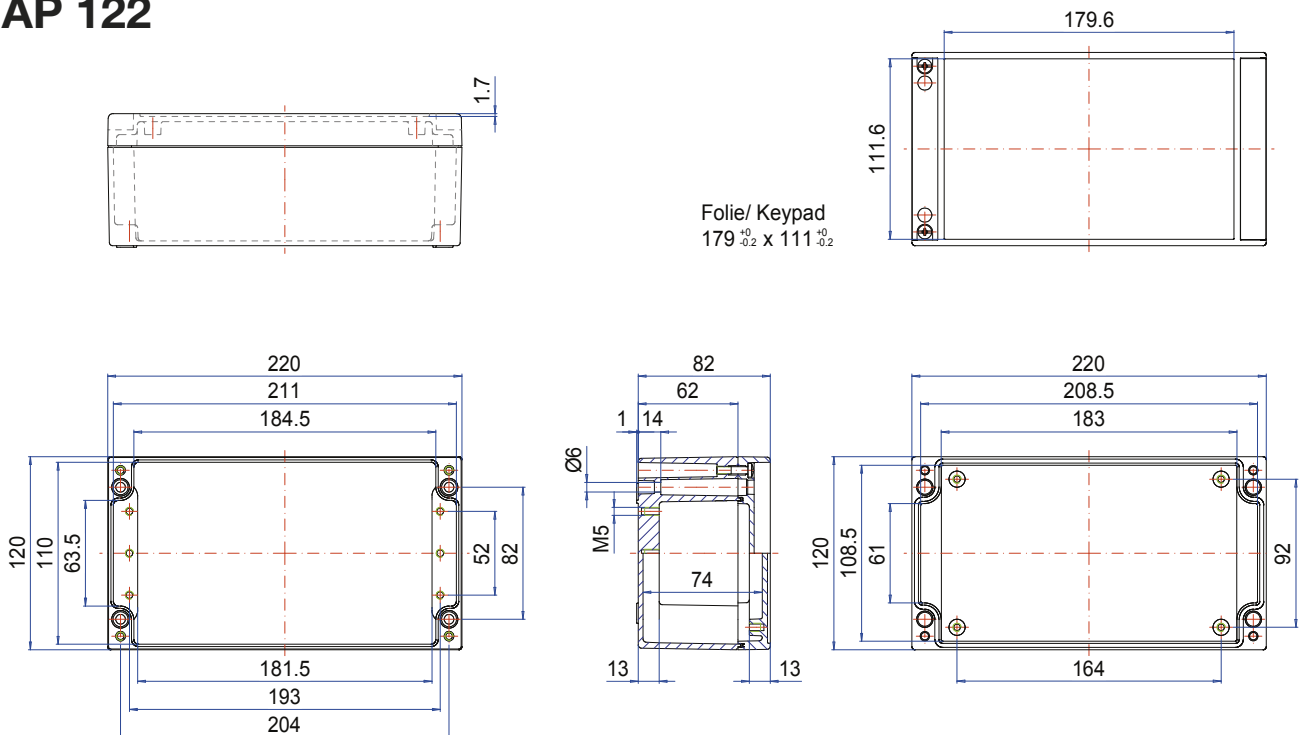

AP 161

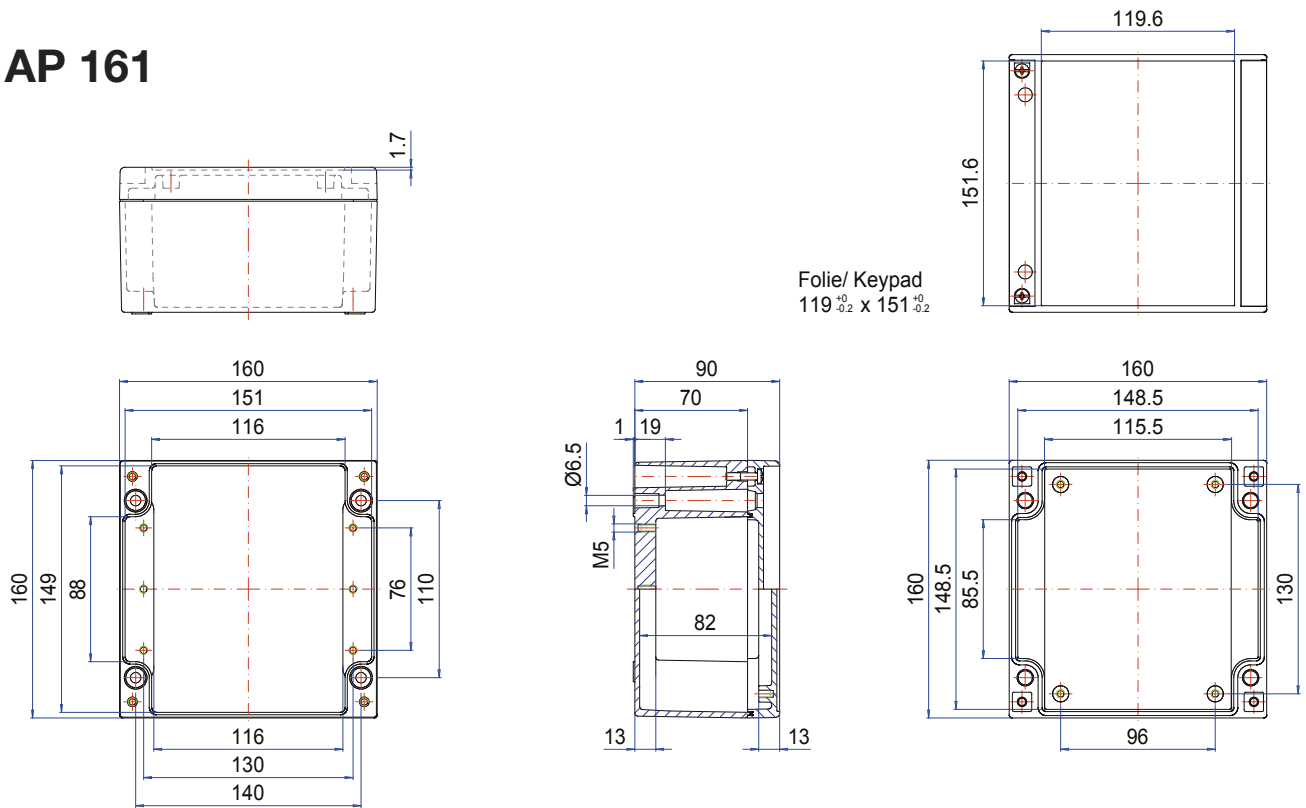

AP 162

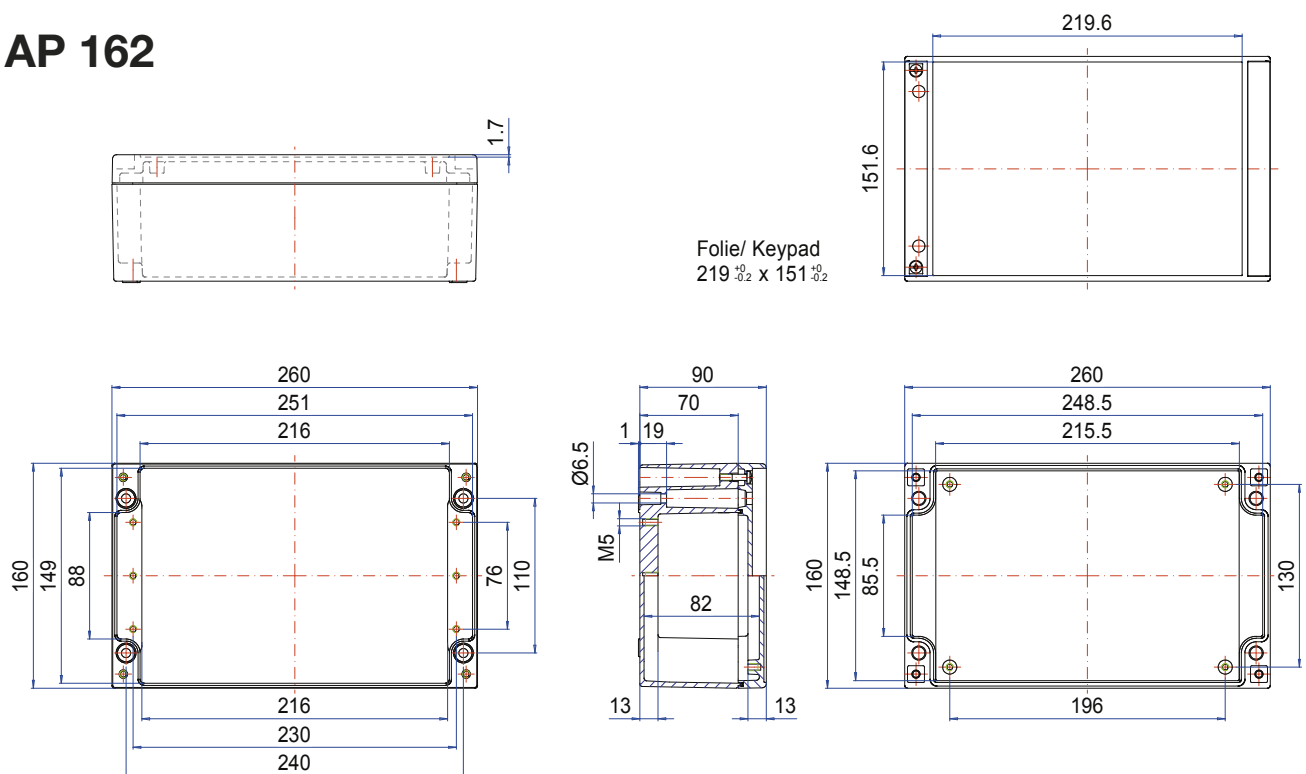



Our *passion* is enclosures.

Just-in-time. Ready for installation.

- Drilled.
- Milled.
- Engraved.
- Printed.
- Powder coated.
- Wet painted.
- Equipped.
- Assembled.
- Delivered.

ROLEC
Gehäuse-Systeme GmbH
Kreuzbreite 2
31737 Rinteln

Fon +49 (0) 57 51/ 40 03-0
Fax +49 (0) 57 51/ 40 03-50

info@ROLEC.de
www.ROLEC.de